



COMPREHENSIVE ZONING BY-LAW

TEMPORARY EXEMPTIONS TO BY-LAW NO. 61-16

By-law No. 16-2021

Effective February 23, 2021 - Expires January 26, 2024

- .1 Notwithstanding Section 5.14 of the By-law, the outdoor storage or parking of a recreational vehicles, specifically a motor home or travel trailer in an Agricultural Zone (A) and in any Non-Urban Residential Zone (SR, RR, RH) (Zoning By-law 61-16) for temporary occupancy during the COVID-19 pandemic, shall be permitted in a minimum required yard subject to the following regulations:
 - .1 Motor homes and travel trailers shall only be permitted on a driveway.
 - .2 That motor homes and travel trailers shall maintain a minimum setback of 1.0 m from city sidewalks, or (where there is no sidewalk) from the curb or road edge to preserve sight lines.
 - .3 That the storage and use of motor homes and travel trailers shall not be permitted on corner lots to preserve sight lines.
 - .4 That the storage and disposal of sewage shall comply with all applicable Provincial and City Standards.
 - .5 That the storage and use of motor homes and travel trailers shall comply with any applicable requirements of the Grand River Conservation Authority and shall be consulted with accordingly, where applicable.
 - .6 That the use of generators for motor homes and travel trailers shall be prohibited.

That all the provisions of Section 5.14 to this By-law, and all other provisions of this By-law, as amended, that are consistent with the provisions herein contained, shall continue to apply mutatis mutandis.

USER'S GUIDE

Introduction

This user guide is intended only to make the Zoning By-Law easier to understand and reference, and to outline how to use the By-Law to find basic zoning information. These pages do not form part of the Zoning By-Law.

If you have any questions about the content of or how to interpret this By-Law, or to obtain any content of this By-Law in an alternate format, please do not hesitate to contact Planning Department.

Purpose of the Zoning By-law

The purpose of this Zoning By-Law is to implement the policies of the County of Brant Official Plan. The Official Plan contains general policies for future land use. These policies specify where certain land uses are permitted and, in some instances, specify what regulations should apply to the development of certain lands. Zoning By-Laws put the plan into effect and provide for its day-to-day administration. They contain specific requirements that are legally enforceable.

Once an Official Plan is in effect, any Zoning By-Law passed by Council must conform to the Official Plan. For example, if the Official Plan stated that lands in the vicinity of a significant natural feature are to remain in their natural state, the Zoning By-Law would prohibit the erection of buildings or structures on those lands.

The Planning Act specifies what a Zoning By-law can regulate:

- how land may be used;
- where buildings and other structures can be located;
- prohibit the use of land or buildings for any use that is not specifically permitted by the By-Law;
- prohibit the erection or siting of buildings and structures on a lot except in locations permitted by the By-Law;
- regulate the type of construction and the height, location, size, floor area, spacing, and use of buildings or structures;
- regulate the minimum frontage and depth of a parcel of land;
- require parking and loading facilities be provided and maintained for a purpose permitted by the By-Law.

How to Use This By-Law

In order to reference this By-Law most easily, a property owner should follow each of the steps listed below to determine what permissions apply to their particular property.

1) Locate the Property on a Map

Maps in a Zoning By-Law are called 'Schedules'. The first step to using this By-Law is to refer to the zone schedules that are contained at the back of the By-Law to determine in which zone category your property is located. The zone category will be indicated on the schedules by a symbol.

For example, a symbol such as "RM3" on your property indicates that your property is within the 'Residential Multiple High Density' Zone. The zone symbols or abbreviations are explained in Section 2 of the By-Law.

2) Zone Provisions and Regulations

Section 6 through 14 of the By-Law explains the uses permitted in each particular Zone and the regulations applying in the Zone. These regulations establish the "building envelope" for development on a lot. The amount of developable area and the types and sizes of buildings allowed are further regulated by other Parts of the By-Law.

3) Definitions

The definitions in Section 3 can assist you if you are not sure of the nature of a permitted use or how it has been defined for the purposes of this By-Law. Words that are defined in Section 3 are italicized throughout the By-Law.

4) General Provisions

Section 4 contains a more generic set of standards known as 'General Provisions' that apply to all properties in all zones throughout the County. For example, the general provisions contain standards that regulate the location of accessory structures on a lot, height exceptions, and non-conforming uses that apply to all properties.

5) Parking and Loading

Section 5 provides the parking and loading requirements for all uses permitted in the County. If you are considering changing the use of your property or adding a new use to your property, you should review Section 5 to ensure that you are aware of the parking requirements for the proposed use.

6) Appendix 1

A series of drawings are provided in the back of this document to assist the reader in interpreting the Zoning By-Law provisions. These drawings are for illustration purposes only and do not form part of the actual By-Law.

LIST OF AMENDING BY-LAWS

The By-Law has been amended by the following zoning by-law amendments:

By-Law No.	Name of Amendment/Location	Status/Effective Date
98-2017	Add cannabis retail use.	June 27, 2017
66-2018	City-wide. Remove Mobile Refreshment Carts, add Food Service Vehicles definitions.	May 24, 2018
160-2018	Repeal Bylaw 98-2017 (cannabis retail use)	December 18, 2018
190-2019	Apply holding to 432 Mount Pleasant Road.	January 15, 2020
192-2019	Remove holding 422 Mount Pleasant Road.	December 18, 2019
158-2020	Technical amendment.	September 22, 2020
16-2021	Temporary exemption to allow motor homes and travel trailers for use during Covid-19 pandemic.	February 23, 2021
208-2021	City-wide definitions for Short Term Rental Accommodation.	November 22, 2021
80-2023	Apply holding to severance of 379 Golf Road.	May 23, 2023
131-2023	Rezone 313 Conklin Road to RM1-12.	July 26, 2023
160-2023	Change zoning future Powerline Road highschool zoning from A to h-N2	October 20, 2023
187-2023	Apply holding and zone change to 672 Powerline Road.	December 22, 2023

TABLE OF CONTENTS

- SECTION 1: APPLICATION AND ENFORCEMENT.....1**
 - 1.1 Title of the By-Law 1
 - 1.2 Lands Subject to the By-Law 1
 - 1.3 Compliance with other Laws 1
 - 1.4 Conformity with the By-Law 1
 - 1.5 Permits 1
 - 1.6 Building Permits..... 1
 - 1.7 Administration..... 2
 - 1.8 Enforcement, Violations and Penalties 2
 - 1.9 Requests for Amendments 2
 - 1.10 Validity 2
 - 1.11 Repeal of former By-Laws 2
- SECTION 2: ZONES, SCHEDULES AND INTERPRETATION3**
 - 2.1 Classification of Zones..... 3
 - 2.2 Schedules to the By-Law 4
 - 2.3 Appendices 5
 - 2.4 Zone Symbols 5
 - 2.5 Special Zone Provisions..... 5
 - 2.6 Bonus Provisions..... 5
 - 2.7 Holding Provisions 5
 - 2.8 Temporary Provisions 5
 - 2.9 Built and Cultural Heritage Areas Overlay..... 6
 - 2.10 Interpreting Zone Boundaries..... 6
 - 2.11 Special Policy Area and Steep Slopes 6
 - 2.12 Interpretation of the By-Law 7
 - 2.13 Abbreviations and Rules of Measurement..... 7
- SECTION 3: DEFINITIONS8**
- SECTION 4: GENERAL PROVISIONS.....49**
 - 4.1 Prohibited Uses..... 49

4.2	Accessory Uses Permitted in all Zones	49
4.3	Connected Structures.....	49
4.4	Regulations for Accessory Buildings and Structures	49
4.5	Accessory Dwelling Unit.....	50
4.6	Day Care Regulations in Commercial and Employment Zones	51
4.7	Daylight Corners/ Visibility Triangles	52
4.8	Drive-Through Facilities	52
4.9	Dwelling Units	53
4.10	Farm Production Outlet Regulations.....	54
4.11	Garden Suites	54
4.12	Greenhouse Regulations	54
4.13	Group Homes.....	55
4.14	Height and Density Bonus Provisions.....	55
4.15	Height Restrictions.....	56
4.16	Home Occupation	57
4.17	Household Sales/Garage Sales/Auction Sales	60
4.18	Landscaped Open Space and Planting Strips	60
4.19	Visual Barrier	61
4.20	Lighting.....	61
4.21	Lot Frontage Regulations	61
4.22	Lots with More than One Zone	62
4.23	Medical Marijuana Production Facility	63
4.24	Minimum Distance Separation	64
4.25	Deleted.....	Error! Bookmark not defined.
4.26	Model Home/Temporary Sales Trailer	64
4.27	Municipal Services	65
4.28	Non-Conforming Uses	65
4.29	Reduced Lot Frontage for Surplus Farm Dwellings	67
4.30	Subsequent Consent and/or Condominium Act	67
4.31	Open Storage	67
4.32	Outdoor Sales or Displays	67
4.33	Propane Fuel Storage and Handling Facilities.....	68

4.34	Setbacks	68
4.35	Shipping Containers	69
4.36	Special Policy Area	70
4.37	Steep Slopes	71
4.38	Swimming Pools.....	71
4.39	Uses Associated with a Restaurant.....	72
4.40	Uses Permitted In all Zones	72
4.41	Uses Prohibited in all Zones	74
4.42	Wellhead Protection Areas.....	76
4.43	Yard Encroachments	76
SECTION 5: PARKING AND LOADING REQUIREMENTS.....		79
5.1	General Requirements	79
5.2	Rounding Provision	79
5.3	Non-Conforming Uses	79
5.4	Exceptions to Downtown Commercial Core	80
5.5	Enclosed Parking Areas/ Parking Structures.....	80
5.6	Requirements for Accessible Parking.....	80
5.7	Specifications for parking/loading and Access regulations	81
5.8	Location of Required Parking and Loading Spaces.....	83
5.9	Surface Treatment and Drainage.....	84
5.10	Loading Space Regulations	84
5.11	Parking Space Requirements for Residential Uses.....	85
5.12	Parking Space Requirements for Non-Residential Uses	86
5.13	Commercial Vehicle Regulations	89
5.14	Recreational Vehicle Regulations	90
SECTION 6: AGRICULTURAL (A) ZONE		92
6.1	Uses Permitted	92
6.2	Zone Requirements.....	92
6.3	Special Exceptions A Zone	93
SECTION 7: AGRICULTURAL EMPLOYMENT (AE) ZONE.....		113
7.1	Uses Permitted	113
7.2	Zone Requirements.....	114

7.3	Special Exceptions AE Zone	114
SECTION 8: URBAN RESIDENTIAL (R) ZONES		127
8.1	Uses Permitted	127
8.2	Zone Requirements.....	128
8.3	Special Exceptions R1 Zone	129
8.4	Special Exceptions R2 Zone	137
8.5	Special Exceptions RM1 Zone	142
8.6	Special Exceptions RM2 Zone	150
8.7	Special Exceptions RM3 Zone	154
SECTION 9: NON-URBAN RESIDENTIAL (NUR) ZONES.....		158
9.1	Uses Permitted	158
9.2	Zone Requirements.....	158
9.3	Special Exceptions SR Zone	159
9.4	Special Exceptions RH Zone	165
9.5	Special Exceptions RR Zone	168
SECTION 10: COMMERCIAL (C) ZONES		174
10.1	Uses Permitted	174
10.2	Zone Requirements.....	175
10.3	Regulations for Accessory Dwellings.....	176
10.4	Regulations for Existing Dwellings	177
10.5	Yard Requirement - Fuel Dispensing	177
10.6	Outdoor Retail Display	177
10.7	Special Exceptions C1 Zone	178
10.8	Special Exceptions C2 Zone	185
10.9	Special Exceptions C3 Zone	193
10.10	Special Exceptions C4 Zone	195
10.11	Special Exceptions C5 Zone	196
10.12	Special Exceptions C6 Zone	197
SECTION 11: EMPLOYMENT (M) ZONES		199
11.1	Uses Permitted	199
11.2	Zone Requirements.....	201

11.3	Yard Requirement for Hotels.....	202
11.4	Open Storage Regulations.....	202
11.5	Special Exceptions M1 Zone	203
11.6	Special Exceptions M2 Zone	207
11.7	Special Exceptions M3 Zone	211
11.8	Special Exceptions M4 Zone	215
SECTION 12: RESOURCE EXTRACTION (EX) ZONE		216
12.1	Uses Permitted	216
12.2	Zone Requirements.....	216
12.3	Special Exceptions EX Zone	217
SECTION 13: INSTITUTIONAL (N) ZONES		219
13.1	Uses Permitted	219
13.2	Zone Requirements.....	220
13.3	Special Exceptions N1 Zone	220
13.4	Special Exceptions N2 Zone	222
SECTION 14: OPEN SPACE (OS) ZONES		223
14.1	Uses Permitted	223
14.2	Zone Requirements for NH Zone	224
14.3	Zone Requirements for OS1, OS2 and OS3 Zones.....	224
14.4	Special Exceptions NH Zone.....	225
14.5	Special Exceptions OS1 Zone	226
14.6	Special Exceptions OS2 Zone	228
14.7	Special Exceptions OS3 Zone	232
SECTION 15: HOLDING (h) AND TEMPORARY (T) ZONES		235
15.1	Holding “h” Zone Provisions.....	235
15.2	Temporary “T” Zone Provisions.....	235
APPENDIX 1: INTERPRETATION DIAGRAMS.....		<i>i</i>

SCHEDULES:

“A” - Zone Maps

“B” - Brantford Municipal Airport Height Restrictions

“C” - Brantford Municipal Airport Protection Overlay Zone

“D” - Wellhead Protection Areas (WHPA) and groundwater recharge areas

SECTION 1: APPLICATION AND ENFORCEMENT

1.1 Title of the By-Law

This By-Law shall be known as the “Comprehensive Zoning By-Law”.

1.2 Lands Subject to the By-Law

The provisions of this By-Law shall apply to all lands lying within the corporate limits of the County of Brant (referred to as “County” in the By-Law).

For the purpose of this By-Law, the corporate limits of the County of Brant exclude the City of Brantford, the Township of Tuscarora being Indian Reserves 40 and 40A, and the portion of the former Township of Onondaga that is part of the Six Nations Reserve being Indian Reserve 40B.

1.3 Compliance with other Laws

All references to statutes or regulations of Government of Canada or the Province of Ontario, or to any other County By-Law, shall be deemed to mean reference to that statute, regulation or By-Law as amended or replaced.

Nothing in this By-Law shall serve to relieve any *person* from any obligation to comply with the requirements of any other County By-Law or any other statute or regulation of the Government of Canada or the Province of Ontario that may otherwise affect the *use* of land, *buildings* or *structures*.

1.4 Conformity with the By-Law

No lands shall be *used* and no *building* or *structure* shall be *erected*, *altered* or *used* within the County except in conformity with the provisions of this By-Law.

1.5 Permits

The requirements of this By-Law must be met before a building permit is issued for the change of *use*, *erection*, addition or *alteration* of any *building* or *structure*.

1.6 Building Permits

This By-Law shall be consider “made under Section 34 of the Planning Act” for the purposes of the Building Code (Ontario Regulation 332/12) Section 1.4.1.3 (1) (f) – Definition of Applicable Law, on the day it comes into force by operation of statute, approval of the approval authority or Ontario Municipal Board, as applicable.

SECTION 1: APPLICATION AND ENFORCEMENT

1.7 Administration

This By-Law shall be administered by a *person* designated by *Council* as Zoning Administrator or such other *person* appointed by the General Manager of Development Services in the event of short term absence.

1.8 Enforcement, Violations and Penalties

This By-Law shall be enforced by the *person* appointed by the *Council*.

Any *person* that contravenes any provision of this By-Law and if the *person* is a corporation, every director or officer of the corporation who knowingly contravenes this By-Law, is guilty of an offense and upon conviction is liable to the penalty as provided for in the Planning Act. The *County* may remedy any violation at the contravening *person's* expenses as authorized by provincial statute.

1.9 Requests for Amendments

Any *person* may apply for a minor variance or amendment to this By-Law as authorized under the Planning Act.

1.10 Validity

A decision of a court of competent jurisdiction that one or more of the provisions of this By-Law or any portion of the Zoning Maps to this By-Law are invalid in whole or in part does not affect the validity, effectiveness, or enforceability of the other provisions or parts of the provisions of this By-Law.

1.11 Repeal of former By-Laws

County of Brant By-Law 110-01 is repealed in its entirety, including all of the Sections, Schedules and Amendments that apply to all lands subject to By-Law 110-01.

SECTION 2: ZONES, SCHEDULES AND INTERPRETATION

2.1 Classification of Zones

The lands subject to this By-Law are divided into the following *Zones*:

Table 2.1 Zone Classifications:

Agricultural Zones

Zone	Symbol	Section
Agricultural	A	6
Agricultural Employment	AE	7

Urban Residential Zones – Section 8

Zone	Symbol
Residential Singles	R1
Residential Singles and Semis	R2
Residential Multiple Low Density	RM1
Residential Multiple Medium Density	RM2
Residential Multiple High Density	RM3

Non Urban Residential Zones – Section 9

Zone	Symbol
Suburban Residential	SR
Residential Hamlet and Villages	RH
Rural Residential	RR

Commercial Zones – Section 10

Zone	Symbol
Neighbourhood Commercial	C1
General Commercial	C2
Shopping Centre Commercial	C3
Core Area Commercial	C4

SECTION 2: ZONES, SCHEDULES AND INTERPRETATION

Zone	Symbol
Mixed Use Commercial	C5
Automotive Commercial	C6

Employment Zones – Section 11

Zone	Symbol
Prestige Industrial	M1
Light Industrial	M2
Heavy Industrial	M3
Energy and Waste Industrial	M4

Resource Extraction Zone – Section 12

Zone	Symbol
Resource Extraction	EX

Institutional Zones – Section 13

Zone	Symbol
Minor Institutional	N1
Major Institutional	N2

Open Space Zones – Section 14

Zone	Symbol
Natural Heritage Zone	NH
Open Space	OS1
Recreational Facilities	OS2
Recreational Trailer Parks	OS3

2.2 Schedules to the By-Law

Schedules “A”, “B”, “C” and “D” which are attached and described in this subsection, form a part of this By-Law to the same extent as if included.

Schedule “A” contains the *Zone* maps that depict the *Zone* category of all lands. All the maps together constitute Schedule “A” of this By-Law.

SECTION 2: ZONES, SCHEDULES AND INTERPRETATION

Schedule “B” depicts the areas affected by the Brantford Municipal Airport Height Restrictions.

Schedule “C” depicts the areas affected by Brantford Municipal Airport Protection Overlay Zone.

Schedule “D” depicts the Wellhead Protection Areas (WHPA) and groundwater recharge areas.

2.3 Appendices

Illustrations provided in Appendix 1 to this By-Law are for illustration purposes only and do not form part of this By-Law.

2.4 Zone Symbols

The *Zone* symbols may be used to refer to *lots, buildings and structures* and to the *uses of lots, buildings and structures* permitted by this By-Law. For each *Zone*, a separate section of this By-Law sets out the *uses permitted, development standards* and the specific provisions relating to such *Zone*.

2.5 Special Zone Provisions

Wherever a *Zone* symbol on Schedule “A” is followed by a dash and a number, such as “R2-1”, special provisions shall apply to such lands. Such special exceptions can be found by reference to that section of the By-Law specified.

2.6 Bonus Provisions

Where the symbol “B” appears on a zoning map as a prefix to any *Zone* symbol, a height and density provision shall apply in accordance with Section 4.14 of this By-Law.

2.7 Holding Provisions

Where the symbol “h” appears on a zoning map as a prefix to any *Zone* symbol, the lands have been placed in a ‘Holding *Zone*’ and Holding *Zone* provisions as set out in Section 15 of this By-Law apply.

2.8 Temporary Provisions

Where the *Zone* symbol on Schedule “A” is preceded by the symbol “T”, a Temporary *Zone*, permitted under Section 39 of the Planning Act shall apply. The reference to Temporary *Zones* can be found in Section 15 of this By-Law.

SECTION 2: ZONES, SCHEDULES AND INTERPRETATION

2.9 Built and Cultural Heritage Areas Overlay

Where a *Zone* symbol on Schedule “A” hereto is preceded by a symbol “HA”, the lands are identified as *Built and Cultural Heritage Areas*. The permitted uses shall be in accordance with the underlying *Zone* requirements.

2.10 Interpreting Zone Boundaries

When determining the boundary of or where uncertainty exists with any *Zone*, the following provisions shall apply:

- (a) *Zone* boundaries shall be construed wherever possible, to be concurrent with municipal boundaries; *lot* boundaries; *streets*, *lanes*, *road allowances*, rights-of-way for railways, *hydro corridors* or pipelines; high water marks; *flooding hazard*; or boundaries of registered plans.
- (b) Where the boundary of a Natural Heritage (NH) *Zone*, as interpreted in the field to the satisfaction of the *Conservation Authority* having jurisdiction, varies from the limit shown on Schedule “A”, the refined limit shall be deemed to be the *Zone* boundary.
- (c) Where the boundary of a *Zone* appears to be parallel to a *street*, a *road allowance* or the *right-of-way* of a railway, *hydro corridor* or pipeline, such boundary shall be construed as being parallel to such feature at the distance determined by the scale of the applicable map on which it is shown.
- (d) In the event that a *street* or *lane* that forms the boundary between two or more different *Zones* is closed, the boundary between such *Zones* shall be construed as the centreline of the said closed *street* or *lane*.
- (e) Where a *lot* is divided into two or more *Zones*, the *Zone* boundary dividing the *lot* shall be deemed to be a *lot line* for purposes of calculating required *setbacks* and coverage, and each portion of the *lot* is required to satisfy the provisions of this By-Law for the applicable *Zone*.
- (f) The *Zone* boundary shall be interpreted to follow the centerline of the streets, *lanes*, *road allowance* and rights-of-way for railways.

2.11 Special Policy Area and Steep Slopes

Where a *Zone* symbol on Schedule “A” is preceded by a small “s” or “ss” (for example, s-C1, or ss-C1), then special requirements apply to such lands that can be found in General Provisions Section 4.36 and 4.37 of this By-Law.

SECTION 2: ZONES, SCHEDULES AND INTERPRETATION

2.12 Interpretation of the By-Law

The definitions and interpretations set out in Section 3 shall apply. Words and terms not defined shall have the customary meaning.

2.13 Abbreviations and Rules of Measurement

a) Abbreviations

- i. ac - acre; acres
- ii. ha - hectare; hectares
- iii. m - metre; metres
- iv. sq. m, m² - square metres

b) Measurements

All measurements of length or area used in this By-Law shall be subject to the normal rules of rounding numbers, unless specifically stated in the By-Law, within the degree of precision specified by the number of digits following the decimal point (if any), so that:

- i. For a whole number, measurements of less than 0.5 shall be rounded downward to the next whole unit;
- ii. For a whole number, measurements of 0.5 and greater shall be rounded upward to the next whole unit;
- iii. For a number having one decimal place, measurements of less than 0.05 shall be rounded downward to the next one-tenth unit;
- iv. For a number of one decimal place, measurements of 0.05 and greater shall be rounded upward to the next one-tenth unit;
- v. Ratios and percentage figures shall not be subject to rounding;
- vi. The rounding provision applies to two decimal places in case of *lot area* calculations;
- vii. Measurements in metric are the requirement of the By-Law.

SECTION 3: DEFINITIONS

Term	Definition
ABATTOIR	Means a <i>building</i> or <i>structure</i> designed to accommodate the penning and slaughtering of animals and the processing of animal carcasses and may include packing, storing and sale of products on premises.
ACCESSORY	<p>Means aiding or contributing in a secondary way to a <i>main use</i> to carry out its function, and having regard to this definition:</p> <p>a) is incidental, subordinate and exclusively devoted to the <i>main use</i> of a <i>lot</i> or <i>building</i> or <i>structure</i>.</p> <p>b) an accessory <i>use</i> is a <i>land use</i> that is accessory to a <i>main use</i>.</p> <p>c) An accessory <i>building</i> or <i>structure</i> that is clearly incidental and exclusively devoted to a <i>main use</i>, <i>building</i> or <i>structure</i>.</p> <p>Accessory <i>buildings</i> may include a <i>private garage</i>, workshop, pool house, shed etc. and shall not be <i>used</i> for human habitation, unless otherwise permitted in this By-Law.</p> <p>Farm machine sheds or other similar agricultural storage <i>buildings</i> shall be deemed accessory <i>buildings</i> for the purpose of this By-Law. Where permitted, <i>buildings used</i> for the harbouring of animals, etc. are deemed <i>main buildings</i> for the purposes of this By-Law.</p>
ADULT ENTERTAINMENT PARLOUR	<p>Means any premises where a trade, calling, business or occupation, services appealing to or designed to appeal to erotic or sexual appetites or inclinations are provided. For the purpose of defining the terms within the definition of “Adult Entertainment Parlour”, the following words shall have the corresponding meanings:</p> <p>“To Provide” , when <i>used</i> in relation to services, includes to furnish, perform, solicit or give such services and “Providing” and “Provided” have corresponding meanings;</p> <p>“Services” includes activities, facilities, performances, exhibitions, viewings and encounters but does not include the exhibition of film approved under the Theatres Act;</p> <p>“Services appealing to or designed to appeal to erotic or sexual appetites or inclinations” include:</p> <p>a) services of which a principal feature or characteristic is nudity or partial nudity of any <i>person</i>;</p> <p>b) services in respect of which the word “nude”, “naked”, “topless”, “bottomless”, “sexy” or any other word or any picture, symbol or representation having like meaning or implication is <i>used</i> in any advertisement.</p>

SECTION 3: DEFINITIONS

Term	Definition
AGRICULTURAL EQUIPMENT SALES AND SERVICE ESTABLISHMENT	Means a <i>lot, building or structure</i> where the business of selling, renting or leasing of new or <i>used</i> agricultural equipments and/or machinery, is conducted and may include the display area, storage area, servicing and repair and an <i>accessory</i> office.
AGRICULTURAL PROCESSING FACILITY	Means a facility, in which agricultural products are preserved, graded, stored or processed for consumption by humans or animals. An Agricultural Processing Facility may include a <i>flour mill</i> , a dairy, a <i>bakery</i> , winery, a grain elevator or an egg grading station, but does not include an <i>abattoir</i> or any premises <i>used</i> for the slaughtering of animals or the boiling of blood, tripe or bones.
AGRICULTURAL SERVICE AND SUPPLY ESTABLISHMENT	Means the <i>use</i> of land, <i>building or structure</i> for the purpose of buying and selling commodities and services that directly support <i>agricultural uses</i> . The establishment must be of a small scale that is intended to serve the local agricultural community and may include the sale, processing and storage of seed, feed, fertilizers, farm fuel suppliers and depots, farm drainage and excavation; <i>agricultural equipment sales and service establishment</i> ; welding; auction sales; well drilling; custom spraying; tillage; and planting and harvesting services.
AGRICULTURAL USE	Means the growing of crops, including nursery, biomass and horticultural crops; raising of <i>livestock</i> ; raising of other animals for food, fur or fibre, including <i>poultry</i> and fish; <i>aquaculture</i> ; <i>apiary</i> ; agro-forestry; maple syrup production; and associated on-farm <i>buildings and structures</i> , including, but not limited to <i>livestock facilities</i> , manure storages, value-retaining facilities, and accommodation for farm labour when the size and nature of the operation requires additional employment.
AISLE	Means a portion of <i>parking area</i> , which abuts a <i>parking space</i> on one or more sides and which provides access from the space to a <i>street or lane</i> , and which is not <i>used</i> for vehicular parking.

SECTION 3: DEFINITIONS

Term	Definition
ALTER	<p>Means:</p> <p>a) When used in reference to a <i>building</i> or <i>structure</i>, shall mean to change any one (1) or more of the internal or external dimensions of such <i>building</i> or <i>structure</i> or to change the type of construction of the exterior walls or roof thereof;</p> <p>b) when used in reference to a <i>lot</i>, the word “alter” means to change the width, <i>lot depth</i>, or <i>lot area</i> or to change the width, depth, or area of any required <i>yard</i>, <i>setback</i>, <i>landscaped open space</i>, or <i>parking area</i>, or to change the location of any boundary of such <i>lot</i> with respect to a <i>street</i> or <i>lane</i>, whether such alteration is made by conveyance or alienation of any portion of said <i>lot</i>, or otherwise; or</p> <p>c) when used in reference to a <i>use</i>, to discontinue and replace a <i>use</i>, in whole or in part, with a <i>use</i> which is defined herein as being distinct from the discontinued <i>use</i> or to add a new <i>use</i> to an <i>existing use</i>.</p> <p>The words “altered” and “alteration” have corresponding meanings.</p>
AMENITY AREA	<p>Means the area situated within the boundaries of a <i>lot used</i> for residential purposes intended for recreational use for the residents, and may include landscaped areas, <i>patios</i>, <i>decks</i>, balconies, communal lounges, swimming pools, play areas and similar <i>uses</i>, but does not include any area occupied at <i>grade</i> by a <i>building’s</i> service areas, <i>parking lots</i>, <i>aisles</i> or <i>driveways</i>;</p>
AMUSEMENT GAME ESTABLISHMENT	<p>Means a <i>building</i> within which more than three amusement game machines are available for <i>use</i> by the public.</p>
AMUSEMENT PARK	<p>Means a <i>lot</i>, <i>building</i> or <i>structure</i> where commercial-recreational, entertainment or amusement activities occur including but not limited to miniature golf, driving range, go-kart tracks, entertainment, exhibitions, the sale of food, beverages, toys and souvenirs constituting the <i>main use</i>, amusement rides, or water slides or water sport, and includes an <i>Amusement Game Establishment</i>.</p>
APIARY	<p>Means a <i>lot</i>, <i>building</i> or <i>structure</i>, used for the purpose of keeping bees and beehives.</p>
AQUACULTURE	<p>Means a <i>lot</i>, <i>building</i> or <i>structure</i>, used for the purpose of hatching, raising and breeding of fish or other aquatic plants or animals.</p>

SECTION 3: DEFINITIONS

Term	Definition
ART GALLERY	Means a <i>lot, building or structure</i> where works of art, such as paintings, sculpture, pottery, glass and weaving are displayed for public viewing, and may include <i>accessory</i> retail sales.
ASSEMBLY HALL	Means a <i>building</i> or part of a <i>building</i> in which facilities are provided for meetings for civic, educational, political, religious, or social activities, and may include a <i>banquet hall</i> or <i>private club</i> , but does not include a <i>place of worship</i> or a <i>school</i> .
ATTIC	Means the space between the roof and the ceiling of the top <i>storey</i> or the space between a dwarf wall and a sloping roof.
AUCTION ESTABLISHMENT	Means a <i>building used</i> for the retail sale of articles or goods to the members of the public bidding the highest offer for the article or goods during the sale proceedings.
AUDITORIUM	Means a <i>building used</i> for the purpose of providing entertainment and includes cinemas and all other places of amusement, but excludes <i>amusement game establishments</i> or <i>adult entertainment parlour</i> .
AUTO BODY SHOP	Means a <i>building or structure, used</i> for the painting or repairing of the exterior and/or undercarriage of <i>vehicle</i> bodies including rust proofing, oil change and may include <i>accessory</i> uses such as towing services and <i>vehicle</i> rentals for customers while the <i>vehicle</i> is under repair and does not include a <i>salvage yard</i> .
AUTOMOBILE	See "VEHICLE".
AUTOMOBILE REPAIR GARAGE	Means a <i>building or structure</i> for the repair or replacement of parts of a <i>vehicle</i> but does not include an <i>auto body shop</i> , an <i>impounding yard</i> , an <i>automobile service station</i> or a gas bar.
AUTOMOBILE SALES OR RENTAL ESTABLISHMENT	Means a <i>lot, building or structure</i> for the sale, rental or leasing of <i>vehicles</i> and <i>vehicle</i> accessories and includes an establishment engaged in the sale of farm implements and equipment, <i>boats</i> , all terrain, ski and other <i>recreational vehicles</i> .
AUTOMOBILE SERVICE STATION	Means an establishment designed for the retail sale of gasoline motor car fuel, diesel fuel, propane, other similar products, electric recharge station, lubricating oil and allied additives and the introduction of such materials into <i>vehicles</i> and may contain facilities for the repair and maintenance of <i>vehicles</i> but does not include an <i>auto body shop</i> , a <i>car wash</i> or a <i>salvage yard</i> . It may include the sale of associated sundry items, tobacco, and snack food provided the <i>gross floor area</i> devoted to the sale of these items does not exceed 150 square metres.

SECTION 3: DEFINITIONS

Term	Definition
AUTOMOTIVE USE	Means an <i>automobile service station, an automobile repair garage, a car wash, an auto body shop or an automobile sales or rental establishment.</i>
AVIARY	Means a cage, building or enclosure for the keeping or raising of any species of birds that are not prohibited pursuant to the County's Animal Control By-Law.
BAKERY	Means a <i>retail store</i> where baked products are offered for sale, some or all of which may be prepared on the premises, but does not include a <i>restaurant.</i>
BALCONY	Means an outside platform being more than 1.8 metres above <i>grade</i> , raised above ground, projecting from the wall of a <i>dwelling</i> and accessible from within the <i>building.</i>
BANQUET HALL	Means a <i>building or structure, used</i> for the purposes of catering to banquets, weddings, receptions and other similar functions for which food and beverages are prepared and served at the premises but shall not include a caterer's establishment.
BASEMENT	Means a <i>storey</i> of a <i>building</i> located partially underground and having its ceiling 1.8 metres or less above <i>grade.</i>
BATCHING PLANT	Means an industrial establishment <i>used</i> for the production of asphalt, concrete, or products thereof <i>used</i> in building or construction and includes facilities for the administration and management of the business, the stockpiling of bulk materials <i>used</i> in the production process or a finished product manufactured on the premises and the storage and maintenance of required equipment, but does not include the retail sales of finished product.
BED AND BREAKFAST ESTABLISHMENT	Means a <i>single detached dwelling</i> in which no more than three rooms are made available by the owner, leasee or the proprietor of the said <i>dwelling</i> , for the purpose of providing temporary accommodation and meals for the travelling public. This does not include a <i>hotel, motel, lodging house, or restaurant.</i>
BERM	Means a landscaped mound of earth, a ledge or step on a slope, or an embankment constructed for stability, aesthetic or noise reduction purposes.
BOAT	Means any vessel propelled by oars, sail, an engine or paddles.

SECTION 3: DEFINITIONS

Term	Definition
BOAT DOCK	Means any <i>structure used</i> or designed to moor a <i>boat</i> . It may be parallel to or angled from a shoreline. For the purposes of this By-Law, a boat dock may be <i>accessory</i> to a residential <i>use</i> or may be a <i>main use</i> as specified in this By-Law. Boat docks are exempt from all <i>yard</i> and elevation requirements of this By-Law.
BOAT HOUSE	Means a <i>building</i> or <i>structure</i> designed or <i>used</i> to house, shelter, or protect a <i>boat</i> or other form of water transportation. A boat house shall not be <i>used</i> for human habitation. When constructed in association with a residential <i>dwelling</i> , a boat house shall be deemed an <i>accessory building</i> and shall be subject to such regulations.
BOAT RAMP	Means any <i>structure</i> or facility <i>used</i> to launch and load <i>boats</i> . For the purposes of this By-Law, a boat ramp may be <i>accessory</i> to a residential <i>use</i> or may be a <i>main use</i> as specified in this By-Law. Boat ramps are exempt from all <i>yard</i> and elevation requirements of this By-Law.
BODY RUB	Means the kneading, manipulating, rubbing, massaging, touching or stimulation, by any means, of a <i>person's</i> body or part thereof, but does not include medical or therapeutic treatment given by a <i>person</i> licensed or registered so to do under the laws of the Province of Ontario.
BODY RUB PARLOUR	Means any premises where a <i>body rub</i> is performed, offered, or solicited in pursuance of a trade, calling, business or occupation by people otherwise duly qualified, licensed or registered under the laws of the Province of Ontario.
BREEZEWAY	Means a covered walkway, with a maximum width of 2 metres, open on all sides from the eaves of the roof to the ground, connecting two or more <i>structures</i> on the same <i>lot</i> .
BREWING ON PREMISES ESTABLISHMENT	Means an agricultural or commercial establishment where individuals produce beer, wine and/or cider, for personal <i>use</i> and consumption off the premises; and where beer, wine and/or cider ingredients and materials are purchased, equipment and storage area is <i>used</i> for a fee by the same individuals.
BUILDING	Means a <i>structure</i> occupying an area greater than ten square metres consisting of a wall, roof and floor or any of them or a structural system serving the function thereof including all plumbing, works, fixtures and service systems appurtenant thereto. A building is <i>used</i> or intended to be <i>used</i> for the shelter, accommodation or enclosure of people, animals or chattels, but does not include any <i>vehicle</i> .

SECTION 3: DEFINITIONS

Term	Definition
BUILDING AREA	Means the horizontal area of a <i>storey</i> above <i>grade</i> within the outside surface of exterior walls or within the outside surface of exterior walls and the centerline of firewalls. The building area excludes open <i>porches</i> , <i>verandas</i> , steps, fire escapes, <i>breezeways</i> and <i>accessory buildings</i> or <i>structures</i> .
BUILDING HEIGHT OR HEIGHT	Means: <ul style="list-style-type: none"> a) in the case of the <i>principal building</i> or <i>structure</i> on a <i>lot</i>: <ul style="list-style-type: none"> (i) the vertical distance between the average finished <i>grade</i> and the highest point of: <ol style="list-style-type: none"> 1. the roof surface of a flat roof; or 2. the decline of a mansard roof; or 3. the mean level between the eaves and the ridge of a gable, hip, gambrel or cottage roof; (ii) 60% of the vertical distance between the average finished <i>grade</i> and the highest point of a <i>building</i> or <i>structure</i> where the transition between wall and roof is undefined, such as in a quonset hut or inflatable <i>structure</i>; b) in the case of an <i>accessory building</i> or <i>structure</i>, the vertical distance between the average finished <i>grade</i> and the midpoint of the roofline; c) in the case of a <i>deck</i> or <i>porch</i> which encroaches into a minimum required <i>yard setback</i>, the highest vertical distance between the finished <i>grade</i> and the highest point of the surface of a <i>deck</i> or <i>porch</i> floor.
BUILDING LINE, ESTABLISHED	Means the <i>existing street setback</i> of an <i>existing main building</i> on a <i>lot</i> , measured between the <i>lot line</i> and the nearest part of such <i>building</i> , excluding any stoops, sun <i>decks</i> , <i>porches</i> , balconies, exterior steps, or architectural adornments.
BUILDING, MAIN OR PRINCIPAL	Means a <i>building</i> in which the <i>main use</i> is conducted on the <i>lot</i> on which it is located. In the case of any Residential <i>Zone</i> , the <i>dwelling</i> is the main or principal building.
BUILDING SUPPLY OUTLET	Means a <i>building</i> or <i>structure</i> or premises where lumber and building materials are kept, processed, sorted and stored and sold to the public and may include facilities for the administration and management of the business and for the storage and maintenance of equipment <i>used</i> in the business, but does not include a <i>batching plant</i> ;

SECTION 3: DEFINITIONS

Term	Definition
BUILT AND CULTURAL HERITAGE	Means a geographical area or one or more significant <i>buildings, structures</i> , monuments, installations or remains associated with architectural, cultural, social, political, economic or military history and identified as being important to a community. These resources may be identified through designation or heritage conservation easement under the Ontario Heritage Act, or listed by local, provincial or federal jurisdictions. It involves a grouping(s) of individual heritage features such as <i>structures</i> , spaces, archaeological sites and natural elements, which together form a significant type of heritage form, distinctive from that of its constituent elements or parts. Examples may include, but are not limited to, heritage conservation districts designated under the Ontario Heritage Act; and villages, <i>parks</i> , gardens, battlefields, main streets and neighbourhoods, cemeteries, trailways and industrial complexes of cultural heritage value.
BULK SALES ESTABLISHMENT	Means the <i>use of lot, building or structure</i> for the purposes of buying and selling lumber, wood, building materials, landscaping materials, feed, fertilizer, beverages, ice, or other similar goods in bulk form but does not include any manufacturing, assembling or processing of such items.
BUNKHOUSE	Means a temporary <i>dwelling</i> used for the housing of seasonal farm workers which is intended not be <i>used</i> a year round and not <i>used</i> as a permanent residence and includes a communal kitchen, bathrooms and sleeping facilities and may include a <i>mobile home</i> .
CAMPGROUND	Means a parcel of land <i>used</i> for camping intended only for temporary seasonal use by vacationing or travelling public. A campground may include cabins, tents, <i>trailers, recreational vehicles, or motor homes</i> but does not include a <i>mobile home</i> . A campground shall not be <i>used</i> or occupied on a year-round basis.
CAMPSITE	Means a parcel of land within a <i>campground</i> <i>used</i> for the accommodation of a <i>recreational vehicle</i> or a tent.
CANOPY	Means an unenclosed roof-like <i>structure</i> projecting more than 0.3 metres from the face of a <i>building</i> , having a rigid frame, and may be attached to said <i>building</i> in such manner as not to become an integral part thereof but does not include awnings or balconies.
CAR WASH	Means a <i>building or structure</i> containing facilities specifically <i>used</i> for washing or cleaning of licenced <i>vehicles</i> either by employing mechanical devices or by hand.

SECTION 3: DEFINITIONS

Term	Definition
CARPORT	Means a roofed <i>structure</i> , which is not wholly enclosed, attached to a wall or walls of a <i>main building</i> and <i>used</i> for the storage of <i>vehicles</i> . The roof of said <i>structure</i> shall be supported by piers or columns so that 50 percent of its wall area adjacent to the <i>side lot line</i> is unenclosed.
CATERING ESTABLISHMENT	Means a <i>building</i> or <i>structure</i> in which food and beverages are prepared for consumption off the premises and are not served to customers on the premises or to take out. A catering establishment may also provide personnel serving equipment and decorations.
CEMETERY	Means land that is <i>used</i> as a place for the interment of the deceased or in which human remains have been buried as defined in the Cemeteries Act and may include a mausoleum, crematorium, or a columbarium.
CHEMICAL AND PHARMACEUTICAL INDUSTRY	Means a <i>building</i> <i>used</i> for the manufacturing, fabrication and processing of chemicals, substances made from chemicals, drugs, medicines and related products, and may also include the manufacturing of orthopaedic, prosthetic and surgical appliances and supplies.
CLUB, PRIVATE	Means a <i>building</i> or <i>structure</i> located on <i>privately</i> owned lands operated on a non-profit basis for social, literary, cultural, political, educational or recreational purposes, primarily for the exclusive <i>use</i> of members and their guests and not open to the general public on an equal basis.
COMMERCIAL PARKING LOT	Means a <i>lot</i> , other than a <i>street</i> , <i>used</i> for the temporary parking of two or more <i>vehicles</i> for profit or gain.
COMMUNITY CENTRE OR COMMUNITY HALL	Means a <i>building</i> or <i>structure</i> in which facilities are provided by a service agency, a club, church or non-profit organization for cultural, religious, welfare, athletic, recreational or community service purposes and may include a <i>day care accessory</i> to the <i>main use</i> .
CONDOMINIUM	Means: a) a <i>building</i> or group of <i>buildings</i> in which units are held in <i>private</i> ownership and floor space, facilities and outdoor areas <i>used</i> in common are owned, administered and maintained by a corporation created pursuant to the provisions of the Condominium Act; and/or b) spaces and features owned in common by all shareholders in a condominium and may include and not limited to right-of-way for vehicular and pedestrian access, walkways, sidewalks, <i>parking</i> and amenity areas that is privately maintained by the corporation created pursuant to the provisions of the Condominium Act.

SECTION 3: DEFINITIONS

Term	Definition
CONSERVATION AUTHORITY	Means Grand River Conservation Authority and Long Point Region Conservation Authority established under Conservation Authorities Act of Ontario.
CONTINUUM-OF-CARE FACILITY	Means a <i>building</i> designed and predominantly occupied by senior citizens and includes a <i>Nursing Home</i> and may include <i>accessory</i> facilities such as <i>hospitals, medical office, retirement homes, recreation centres, cafeterias and personal service establishments.</i>
CONTRACTOR'S YARD	Means a <i>lot, building or structure</i> occupied by a construction company or contractor and <i>used</i> as a depot for the storage and maintenance of equipment and includes the offices of general building contractors, general contractors, specialized trades and <i>building</i> maintenance services such as landscaping services, window cleaning and extermination services and also includes assembly work and the stockpiling or storage of supplies <i>used</i> in the business.
CONVENIENCE STORE	Means a <i>retail store</i> that provides a variety of household necessities, groceries and other convenience items primarily to the immediate neighbourhood, but shall not include appliances, electronics, apparel, luggage, jewelry, sporting goods, hardware, paint, and other similar products provided the <i>gross floor area</i> does not exceed 150 square metres.
COUNCIL	Means the Municipal Council of the Corporation of the County of Brant.
COUNTY	Means the Corporation of the County of Brant.
CRAFTS SHOP	Means a <i>building</i> , which is <i>used</i> for the creation of craft articles such as leatherwork, pottery, woodwork, hand woven goods and similar articles, primarily by manual methods.
DAY CARE	<p>Means a <i>building</i> duly licensed by Child Care and Early Years Act that receives more than five (5) children who are not of common parentage, primarily for the purpose of providing temporary care or guidance or both, for a continuous period not exceeding twenty-four hours, where the children are:</p> <ul style="list-style-type: none"> a) under eighteen years of age in the case of a day nursery for children with a developmental disability, and b) under ten years of age in all other cases. <p>A Day Care does not include a <i>public school or private school</i> under the Education Act.</p>

SECTION 3: DEFINITIONS

Term	Definition
DAY CARE, PRIVATE HOME	Means a residence duly licensed by Child Care and Early Years Act that receives a maximum of five (5) children who are not of common parentage, primarily for the purpose of providing temporary care or guidance or both, for a continuous period not exceeding fourteen (14) hours.
DECK	Means an unenclosed <i>structure</i> , which may be attached or detached to a <i>building</i> and intended for the purpose of outdoor dining, lounging, and other similar <i>accessory residential uses</i> . For the purposes of this By-Law, a deck is considered to be an <i>accessory structure</i> .
DENSITY	Means the ratio of <i>dwelling units</i> to the net <i>lot area</i> .
DEVELOPMENT	<p>Means the creation of a new <i>lot</i>, a change in land <i>use</i>, or the construction of <i>buildings</i> and <i>structures</i> requiring approval under the Planning Act or Ontario Building Code but does not include:</p> <ul style="list-style-type: none"> a) activities that create or maintain infrastructure authorized under an environmental assessment process; b) works subject to the Drainage Act; or c) underground or surface mining of minerals or advanced exploration on mining lands in significant areas of mineral potential in Ecoregion 5E, where advanced exploration has the same meaning as under the Mining Act.
DORMITORY	Means a <i>building</i> or a part of a <i>building</i> , operated by an institution as an <i>accessory use</i> , <i>used</i> or intended to be <i>used</i> for sleeping accommodations only and does not include individual kitchen facilities, except a group kitchen facility may be provided to serve the residents.
uDRIVEWAY	Means a defined area providing access for motor <i>vehicles</i> from a <i>public or private street</i> or a <i>lane</i> to facilities such as a <i>parking area</i> , <i>parking lot</i> , <i>loading space</i> , <i>private garage</i> , <i>building</i> or <i>structure</i> .
DRIVE-THROUGH FACILITY	Means a <i>building</i> or <i>structure</i> , where goods and/or services are offered to the public while the customers may or may not remain in their motor <i>vehicles</i> . Drive-through facilities may serve as the primary <i>use</i> of the site or may serve as an <i>accessory use</i> .

SECTION 3: DEFINITIONS

Term	Definition
DRY CLEANING AND LAUNDROMAT	Means a <i>building used</i> for the purpose of receiving articles of clothing to be subjected to the process of dry cleaning or dry dyeing or cleaning elsewhere and for the pressing and/or distribution of any such articles or goods which have been subjected to any such process. The facility may also include a self-serve clothes washing establishment containing one or more washing and drying, ironing, finishing or other incidental equipment in which only water, detergents or soap are <i>used</i> .
DRY CLEANING ESTABLISHMENT	Means a <i>building</i> where dry cleaning, dry dyeing, cleaning or pressing of articles of clothing is carried on and may include a <i>dry cleaning and laundromat</i> .
DWELLING	Means a place of residence occupied by one (1) or more people, with one or more <i>habitable rooms</i> containing separate kitchen and bathroom facilities for <i>private</i> use as a single housekeeping unit or containing more than one (1) units, but shall not include <i>park model trailer, hotels, lodging house, nursing homes, motels, or trailers</i> .
(i) DWELLING, ACCESSORY	Means a <i>dwelling</i> which is <i>accessory</i> to a permitted non-residential <i>use</i> .
(ii) DWELLING, ACCESSORY UNIT	Mean a self-contained dwelling unit located within a single detached dwelling, a semi-detached dwelling, a rowhouse dwelling, a street fronting rowhouse dwelling, or an associated accessory buidlg, and is accessory to the principal residence.
(iii) DWELLING, APARTMENT	Means a <i>building</i> consisting of four or more <i>dwelling units</i> , in which each of the units obtain access through a common entrance from the <i>street</i> level and where the occupants have the right to use in common halls, stairs, <i>yards</i> and <i>accessory buildings</i> .
(iv) DWELLING, CONVERTED	Means an <i>existing dwelling</i> , constructed as a single or semi-detached unit that has been <i>altered</i> internally to provide one or more additional <i>dwelling units</i> .
(v) DWELLING, DUPLEX	Means a <i>building</i> , other than a <i>converted dwelling</i> , that is divided horizontally into two (2) separate <i>dwelling units</i> each of which has an independent entrance either directly from the outside or through a common entrance.
(vi) DWELLING,	Means a <i>building</i> that is divided horizontally and/or vertically into

SECTION 3: DEFINITIONS

Term	Definition
FOURPLEX	four (4) separate <i>dwelling units</i> , each of which has an independent entrance either directly from the outside or through a common entrance, but does not include a <i>converted dwelling</i> or a <i>rowhouse dwelling</i> .
(vii) DWELLING, MOBILE HOME	See "MOBILE HOME".
(viii) DWELLING, MODULAR	Means a prefabricated <i>building</i> constructed to Canadian Standards Association (CSA) standard and which is designed to be <i>used</i> as a <i>dwelling unit</i> whether temporary or permanent, and assembled on site.
(ix) DWELLING, MULTIPLE	Means a <i>dwelling</i> containing more than three (3) <i>dwelling units</i> .
(x) DWELLING, ROWHOUSE	Means a <i>building</i> divided vertically into three (3) or more attached <i>dwelling units</i> with each unit having a separate entrance, and so located on a <i>lot</i> that individual units shall have <i>frontage</i> on a <i>private street</i> .
(xi) DWELLING, SEASONAL /COTTAGE	Means a <i>dwelling used</i> only for recreation or seasonal purposes, with temporary living accommodations which are intended not be a year round and not considered as a permanent residence, and may include a <i>trailer</i> or a <i>mobile home</i> .
(xii) DWELLING, SEMI-DETACHED	Means two (2) <i>dwelling units</i> attached with a common wall, dividing the <i>dwelling</i> s vertically, each of which has an independent entrance either directly from the outside or through a common vestibule. The common wall joining the two (2) units may be the residential portion, the <i>garage</i> portion or the <i>garage</i> and residential portion.
(xiii) DWELLING, SINGLE DETACHED	Means a <i>dwelling unit</i> that is freestanding, separate and detached from other <i>buildings</i> or <i>structures</i> , but does not include a <i>mobile home</i> .
(xiv) DWELLING, STACKED TOWNHOUSE	Means a <i>dwelling unit</i> within a <i>building</i> divided into a minimum of three non-communicating <i>dwelling units</i> , each <i>dwelling unit</i> being separated from the other vertically and horizontally.

SECTION 3: DEFINITIONS

Term	Definition
(xv) DWELLING, STREET FRONTING ROWHOUSE	Means a <i>building</i> divided vertically into three (3) or more attached <i>dwelling units</i> with each unit having a separate entrance, and located such that individual units have frontage on a <i>public street</i> .
(xvi) DWELLING, TRIPLEX	Means a <i>dwelling unit</i> that is divided horizontally into three separate <i>dwelling units</i> each of which has an independent entrance either directly from the outside or through a common entrance.
(xvii) DWELLING UNIT	Means a suite of one or more <i>habitable rooms</i> used by one (1) or more individuals living together, in which cooking, eating, living, sleeping and sanitary facilities are provided, which has a private entrance directly from outside the <i>building</i> , from a common hallway or from a common stairway. A <i>dwelling unit</i> does not include a <i>bunk house, group home, mobile home or recreational vehicle</i> .
(xviii) ACCESSORY UNIT	Means a self-containing dwelling unit located within a single detached dwelling, a semi-detached dwelling, a rowhouse dwelling, a street fronting rowhouse dwelling, or an associated accessory building, and is accessory to the principal residence.
EASEMENT	See "RIGHT-OF-WAY".
EATING ESTABLISHMENT	Means a <i>building</i> where food is offered for sale or sold to the public for immediate consumption or take-out and includes such <i>uses</i> as a <i>restaurant, café, cafeteria, ice cream parlour, tea or lunch room, coffee shop, snack bar</i> , but does not include a <i>lodging house or a food service vehicle</i> .
ELECTRICAL AND ELECTRONIC PRODUCTS INDUSTRY	Means an industry involved in the production of, but not limited to, appliances, lighting products, audio and video products, computer products, communications products, electrical transformers and switches, energy, wire and cable products.
ELECTRICITY GENERATION FACILITY	Means a <i>lot, building or structure used</i> for the production of electrical power using wind, water, solar or geothermal energy, biomass, coal, or other forms of natural energy and feed it into the general power grid, and includes such systems or utilities participating or intended to participate in the Ontario Power Authority's Feed-In Tariff Program, or successor thereof, or similar program.
ENERGY FROM	Means conversion of non-recyclable waste materials into useable

SECTION 3: DEFINITIONS

Term	Definition
WASTE	heat, electricity, or fuel through a variety of processes, including combustion, gasification, pyrolysis, anaerobic digestion, and landfill gas recovery and is also called waste-to-energy.
ERECT	<p>Means to build, construct, re-construct, <i>alter</i> or relocate any <i>building</i> or <i>structure</i> and includes, without limiting the generality of the foregoing:</p> <ul style="list-style-type: none"> a) The performance of any preliminary physical operation, such as excavating, grading, filling or draining; or b) Any work for which a building permit is required under the Ontario Building Code. <p>ERECTED” and “ERECTION” have corresponding meanings.</p>
EXISTING	Means <i>legally</i> existing on the effective date of this By-Law.
FAIRGROUND	Means a <i>lot</i> , <i>building</i> or <i>structure</i> , intended primarily for temporary uses, including but not limited to, exhibitions of farm, educational, household and manufactured products and displays and/or activities for entertainment, recreational, hobby, charitable or estate purposes, including <i>eating establishments</i> , auctions and retail sales.
FARM LABOUR HOUSING	Means a <i>building</i> constructed or manufactured to be moved from one place to another, installed on a temporary foundation with no <i>basement</i> and shall be <i>used</i> for the temporary accommodation of seasonal farm workers. A farm labour housing shall only be occupied for not more than nine (9) months within a twelve (12) month period within any given year. It should not serve as the <i>principal</i> place of the residence of an occupant and should be located on the farm on which the seasonal workers are employed. A <i>bunkhouse</i> or a <i>mobile home</i> or a <i>recreational vehicle</i> may be <i>used</i> for the purposes of a farm labour housing.
FARM PRODUCTION OUTLET	Means a <i>building</i> , <i>structure</i> or <i>use accessory</i> to an <i>agricultural use</i> and engaged in the storage, handling and sale of farm produce or agricultural products that are produced or grown on the <i>lot</i> or neighbouring farming operation and is not intended to include a commercial business. This definition does not include landscaping and garden supplies business.
FEED MILL	Means a <i>building</i> wherein farm commodities such as cereal grain, corn, and soybeans etc. are brought, stored, dried, processed and sold, and also includes the drying, processing and elevation for storage of farm commodities.

SECTION 3: DEFINITIONS

Term	Definition
FERTILIZER BLENDING STATION	Means a <i>building</i> wherein different grades of fertilizers to be <i>used</i> by farmers are mixed to create compounds for use by the farming community.
FINANCIAL INSTITUTION	Means a <i>building</i> which is <i>used</i> to provide financial services directly to the public, and includes <i>uses</i> such as a bank, trust company, credit union, securities dealer, finance companies and stockbrokers.
FISH FARM	Means <i>use</i> of a <i>lot</i> for the creation of ponds, waterways and other facilities for the spawning, growing, feeding and sale of fish.
FLOOD, ONE HUNDRED YEAR	Means the flood, for river, stream and small inland intake systems, based on an analysis of precipitation, snow melt, or a combination thereof, having a return period of 100 years on average, or having 1% chance of occurring or being exceeded in any given year.
FLOODING HAZARD	<p>Means the inundation, under the conditions specified below, of areas adjacent to a shoreline or a river or stream system or small inland lake systems, and not ordinarily covered by water:</p> <p>a) the flooding hazard limit is the greater of:</p> <p style="padding-left: 40px;">i) the flood resulting from the rainfall actually experienced during the major storm such as Hurricane Hazel storm (1954) transposed over a specific watershed and combined with the local conditions, where the evidence suggests that the storm could have potentially occurred over watersheds in the general area;</p> <p>OR</p> <p style="padding-left: 40px;">ii) the <i>One Hundred Year Flood</i>.</p>
FLOODPROOFING	Means the combination of measures incorporated into the basic design and/or construction of <i>buildings, structures, or lots</i> to reduce or eliminate <i>flooding hazards, wave uprush</i> and other water-related hazards along the shorelines of the large inland lakes, and <i>flooding hazards</i> along river, stream and small inland lake systems.
FLOOR AREA	Means the total area of the floor in a <i>building</i> measured to the outside of all exterior walls or the centre of common walls, excluding any <i>basement, garage, carport</i> and unenclosed <i>porch</i> . A <i>basement</i> associated with a <i>restaurant use, used</i> for storage purposes shall not be included in the calculation of permitted floor

SECTION 3: DEFINITIONS

Term	Definition
	<p>area.</p> <p>For <i>accessory buildings or structures</i>, <i>floor area</i> means the total area of all floors measured to the outside of all exterior walls.</p>
<p>FLOOR AREA, GROSS</p>	<p>Means the sum of the areas of each floor of a <i>building</i>. Measurement shall be from the exterior face of outside walls, or from the center line of partition and common walls.</p> <p>Gross floor area shall not include floor space devoted to:</p> <ul style="list-style-type: none"> a) <i>Vehicle</i> Parking b) A <i>storey</i> having a <i>height</i> of 1.5 metres or less
<p>FLOOR AREA, LEASABLE</p>	<p>Means the aggregate area of all floors in a <i>building</i> measured from the centre line of the joint interior partitions and from the exteriors of outside walls, and <i>used</i> or capable of being <i>used</i> for commercial purposes, such as sales, display, storage and offices.</p> <p>Leasable floor area shall not include floor space <i>used</i> in common such as:</p> <ul style="list-style-type: none"> a) <i>parking areas</i> b) Mechanical room boiler room, maintenance room, or electrical or <i>utility</i> room c) Common hallways, stairways d) Elevators and associated equipment e) Washrooms f) Foyers, lobbies, but not waiting areas/rooms g) A <i>storey</i> having a <i>height</i> of 1.8 metres or less
<p>FLORIST SHOP</p>	<p>Means a <i>retail store</i> devoted to the sale of flowers, indoor plants and arrangements thereof.</p>
<p>FLOUR MILL</p>	<p>Means a facility or a <i>building</i> wherein cereal grains and other agricultural commodities are processed to create new by-products such as flour.</p>
<p>FOOD PROCESSING PLANT</p>	<p>Means a <i>building used</i> for the processing and packaging of meat and <i>poultry</i> products, fish products, fruit and vegetable products, dairy products, flour, vegetable oil mills, sugar products, beverages and tobacco products, for human consumption but does not include an <i>abattoir</i> or any premises <i>used</i> for the slaughtering of animals or the boiling of blood, tripe or bones.</p>
<p>FOOD SERVICE VEHICLES</p>	<p>Shall mean a vehicle not permanently affixed to the ground and capable of being moved on a daily basis, from which food</p>

SECTION 3: DEFINITIONS

Term	Definition
	intended for consumption is provided for sale, sold or is prepared, and includes a motorized, self-propelled vehicle (i.e. food truck), a vehicle that is not self-propelled, but can be towed (i.e. food trailer) and a vehicle moved by human effort (i.e. food cart). <i>Food Service Vehicles</i> include, but are not limited to such vehicles as catering vehicles, chip hut, food trucks, ice cream vending vehicle, and mobile refreshment carts.
FORESTRY USE	Means the <i>use</i> of a <i>lot</i> for the purpose of conservation and/or the growing and cutting of trees for fuel wood, pulp, wood products such as firewood, lumber, Christmas trees, but shall not include <i>lumber mills</i> .
FUEL PUMP ISLAND	Means that portion of an <i>automobile service station</i> , gas bar or portion of a non-residential <i>use</i> for the retail sale of automotive fuels that includes the fuel pumps, concrete base, overhead canopy and kiosk, but shall not include any part of any <i>building</i> for the repair or service of <i>vehicles</i> .
FUEL STORAGE TANK	Means an underground or above ground tank for the bulk storage of petroleum gasoline, fuel oil, gas or combustible liquid or fluid.
FUNERAL HOME	Means a <i>building</i> designed for the purpose of furnishing funeral supplies and services to the public and includes facilities intended for the preparation of the bodies for interment or cremation off site and may include a chapel.
GARAGE/ PRIVATE GARAGE	Means an <i>accessory building or structure</i> , which is <i>used</i> or intended to be <i>used</i> for the storage of motor <i>vehicles</i> and in which there are no facilities for repairing or servicing such <i>vehicles</i> for gain or profit, and includes a <i>carport</i> .
GARAGE, MUTUAL	Means a <i>private garage</i> which contains sufficient space for the parking of not less than two (2) <i>vehicles</i> ; and a) is situated astride a common <i>side lot line</i> between two (2) adjacent <i>lots</i> ; and b) is <i>accessory</i> to a <i>main use</i> on each of such <i>lots</i> .
GARDEN SUITE	Means a one-unit detached residential <i>structure</i> containing bathroom and kitchen facilities that is <i>accessory</i> to an <i>existing</i> residential <i>structure</i> and that is designed to be portable.

SECTION 3: DEFINITIONS

Term	Definition
GOLF COURSE	Means a public or <i>private</i> area <i>used</i> and operated for the purpose of playing golf and may include <i>accessory</i> uses, including a clubhouse, office, pro shop, <i>restaurant</i> , <i>banquet hall</i> and lounge, driving range, pitch and putt, putting green and maintenance <i>buildings</i> .
GRADE	Means the average elevation of the finished surface of the ground at the base of the outside walls of a <i>building</i> or <i>structure</i> .
GRAIN ELEVATOR AND DRYING FACILITY	Means a facility, <i>building</i> or <i>structure</i> wherein agricultural commodities such as cereal grains, corn and soy beans are customarily dried and, stored.
GREENHOUSE, COMMERCIAL	Means the <i>use</i> of a <i>lot</i> , <i>building</i> or <i>structure</i> for the growing of flowers, fruits, vegetables, plants, shrubs, trees and similar vegetation for the purpose of transplanting, for use as stock or grafting, and includes the retail sale or wholesale distribution of such items directly from the <i>lot</i> including the sale of associated items such as soil, mulch, planting mediums, fertilizers and similar materials.
GREENHOUSE, FARM	Means the <i>use</i> of <i>lot</i> , <i>buildings</i> or <i>structures</i> for the growing of flowers, fruits, vegetables, plants, shrubs, trees and similar vegetation which may be transplanted outdoors on the same <i>lot</i> , but does not include retail.
GROCERY STORE/ SUPERMARKET	Means a <i>retail store</i> specializing in food products and without limiting the generality of the foregoing includes, food products, <i>bakery</i> , confectionery, pet food, milk products, etc. but does not include a butcher shop, or a <i>restaurant</i> .
GROUND FLOOR	Means the <i>storey</i> of a <i>building</i> at the average <i>grade</i> at the front of the <i>building</i> . In the case of <i>buildings</i> fronting on two <i>streets</i> , the ground floor is the <i>storey</i> at the average of the <i>grade</i> of the two <i>street</i> frontages.
GROUP HOME	Means a single housekeeping unit supervised by staff on a daily basis which provides special care and treatment to people for physical or mental deficiency, physical handicap or other such cause. A group home shall be funded, licensed, approved, or supervised by the Province of Ontario under a general or specific Act, for the accommodation of not less than three (3) and not more than eight (8) residents, exclusive of staff. A group home may contain an office provided that the office is <i>used</i> only for the administration of the group home in which it is located.

SECTION 3: DEFINITIONS

Term	Definition
GROUP HOME, CORRECTIONAL	<p>Means a single housekeeping unit supervised by staff on a daily basis for people who have been placed on probation, released on parole or admitted for correctional purposes. A correctional group home shall be funded, licensed, approved or supervised by the Province of Ontario, for the accommodation of not less than three (3) and not more than eight (8) residents, exclusive of staff. A correctional group home may contain an office provided that the office is <i>used</i> only for the operation of the correctional group home in which it is located.</p> <p>A correctional group home shall not include any detention or correctional facility operated by any <i>public agency</i>.</p>
HABITABLE ROOM	<p>Means any room within a <i>dwelling unit used</i> or intended to be <i>used</i> for living, sleeping, eating or food preparation, but does not include a washroom, laundry room, closet, staircase, sunroom, <i>porch</i>, <i>private garage</i>, furnace room, or any space <i>used</i> for the service and maintenance of such <i>dwelling</i>.</p>
HAZARDOUS LANDS OR SITES	<p>Means a <i>lot</i> or lands that could be unsafe for <i>development</i> due to naturally occurring processes. Along river, stream and small inland lake systems, this means the land, including that covered by water, to the furthest landward limit of the <i>flooding hazard</i> or erosion hazard limits. It also includes <i>lots</i> or lands that could be unsafe for <i>development</i> and site <i>alteration</i> due to naturally occurring hazards. These may include unstable soils (sensitive marine clays, organic soils) or unstable bedrock (karst topography).</p>
HERITAGE BUILDING	<p>Means a <i>building</i> designated under Part IV of The Ontario Heritage Act.</p>
HOME IMPROVEMENT CENTRE	<p>Means the <i>use</i> of a <i>lot</i>, <i>building</i> and <i>structure</i> in which goods, wares and articles relating to home improvements and furnishings are displayed and offered for sale or rental. A home improvement centre may include, but not be limited to, furniture, drapes, carpet, paint supplies, home entertainment equipment, sports and recreational equipment, interior and exterior decorating supplies, plants and flowers, garden tools and supplies and other similar products.</p>
HOME OCCUPATION	<p>Means an occupation, trade, profession, business or craft, which is carried on as an <i>accessory use</i> to the <i>dwelling unit</i>, provided that the <i>dwelling unit</i> is the <i>principal</i> residence of the person carrying on the said occupation. A home occupation shall not include a <i>retail store</i> or a <i>convenience store</i> or <i>restaurant</i> or a <i>body rub parlour</i>.</p>
HOSPITAL	<p>Means a hospital as defined in the Private Hospitals Act or in</p>

SECTION 3: DEFINITIONS

Term	Definition
	Public Hospitals Act but shall not include a <i>veterinary clinic</i> .
HOTEL	Means any motel, tavern, inn, lodge, or public house designed and <i>used</i> mainly for the purposes of catering to the needs of the traveling public by supplying food and furnishing sleeping accommodation of more than four (4) guest rooms, each having no facilities for cooking or housekeeping, provided that each guest room may only be entered from the interior of the <i>building</i> . A hotel may also provide <i>uses</i> and activities <i>accessory</i> to the <i>principal</i> accommodation function including gift shop, fitness or health club and meeting rooms. A hotel does not include a <i>group home, lodging house</i> or <i>multiple dwelling</i> .
HOUSEHOLD PET	Means a domestic animal that by the nature of its temperament or appearance is kept for the purpose of personal enjoyment or protection rather than for commercial purposes, which normally spends its time in the <i>dwelling unit</i> of the owner, and shall include indoor pets such as caged birds, caged rodents or rabbits, cats, dogs, tropical fish, and non-poisonous indigenous reptiles, but shall not include <i>livestock</i> or any other animal listed as a prohibited animal in the County's Animal Control By-Law.
HOUSEHOLD SALE/GARAGE SALE	Means the sale by an occupant of a <i>dwelling unit</i> , on their own premises, of household goods belonging to them.
HYDRO CORRIDOR	Means corridors used for the transmission and distribution of electricity.
IMPOUNDING YARD	Means a place to which disabled <i>vehicles</i> , or other mobile equipment impounded for a breach of the law, may be taken or towed and stored temporarily until reclaimed, but does not include an <i>automobile service station, automobile repair garage, auto body shop, salvage yard</i> .
KENNEL	Means a place where dogs or other domestic animals other than <i>livestock</i> or <i>poultry</i> are raised or bred or kept for sale or to be entered into authorized and recognised competitions, exhibitions, sporting or hunting events.
KENNEL, BOARDING FACILITY	Means a place where dogs or other domestic animals other than <i>livestock</i> or <i>poultry</i> are kept for a fee on a temporary basis, but does not include a <i>veterinary clinic</i> .
LANE	Means a walkway, emergency access or any other passageway or <i>right-of-way</i> , open from ground to sky, not constituting a <i>street</i> but laid down upon a registered plan and dedicated to <i>public use</i> , as a <i>right-of-way</i> for <i>use</i> in common by adjacent land owners.

SECTION 3: DEFINITIONS

Term	Definition
LANDSCAPED OPEN SPACE	Means the open and unobstructed space at <i>grade</i> which is suitable for the growth and maintenance of grass, flowers, hedges, bushes, shrubs, trees and other natural and/or built landscaping features and may include a pedestrian walkway, <i>patio</i> or similar area, but does not include any <i>driveway</i> , ramp or parking or loading area or an <i>agricultural use</i> .
LEGAL OR LAWFUL	Means a <i>use</i> , a <i>lot</i> , a <i>building</i> or a <i>structure</i> allowed by law, which complies with any and all restrictions lawfully imposed by the corporation or by any governmental authority having jurisdiction to make such restrictions or regulations.
LIBRARY	Means a <i>building used</i> for the collection of printed, electronic, and pictorial material for public use for the purposes of study, reference, and recreation, and which may include meeting rooms for community use, activity areas and cafeteria.
LIVESTOCK	Includes beef cattle, birds, dairy cattle, deer & elk, fur-bearing animals, game animals, goats, horses, <i>poultry</i> , ratites, sheep, swine, and other animals as defined in the <i>Minimum Distance Separation Guidelines</i> .
LIVESTOCK FACILITY	Means a barn, <i>building</i> or <i>structure</i> with <i>livestock</i> occupied portions intended for keeping or housing of <i>livestock</i> . A livestock facility shall also include all manure or material storages and anaerobic digestors.
LIVESTOCK SALES MARKET	Means a <i>lot</i> , <i>building</i> or <i>structure</i> where <i>livestock</i> is brought and sold and includes auctioning of <i>livestock</i> .
LOADING SPACE	Means an off-street space or berth located on the same <i>lot</i> as a permitted <i>use</i> and <i>used</i> for the parking of a <i>commercial vehicle</i> while loading or unloading merchandise or materials pertinent to such permitted <i>use</i> .
LODGING HOUSE/ BOARDING HOUSE OR ROOMING HOUSE	Means a <i>building</i> : <ul style="list-style-type: none"> a) that has a <i>building height</i> not exceeding three <i>storeys</i>, b) <i>building area</i> not exceeding 600 m², c) in which lodging is provided for more than four people in return for remuneration or for the provision of services or for both, and d) in which the lodging rooms do not have both <i>private</i> bathrooms and kitchen facilities for the exclusive <i>use</i> of individual occupants.

SECTION 3: DEFINITIONS

Term	Definition
	A lodging house shall not include a <i>hotel</i> , motel, <i>hospital</i> or <i>nursing home</i> or a residence of an educational institution.
LOT	Means a parcel of land under one ownership which: <ul style="list-style-type: none"> a) is established as a separate parcel of land legally capable of conveying on title, in accordance with the provisions of the Planning Act, b) is described as a lot or block on a registered plan of subdivision, excluding a subdivision which has been deemed not to be a plan of subdivision under the Planning Act; or c) is the whole remnant after a <i>lawful</i> conveyance.
LOT AREA	Means the total horizontal area within the <i>lot lines</i> of a <i>lot</i> , but does not include any portion of a <i>lot</i> that is covered by water or below the <i>top of bank</i> as determined by an Ontario Land Surveyor.
LOT, CORNER	Means a <i>lot</i> situated at the intersection of and abutting two (2) or more <i>streets</i> , provided that the angle of intersection of such <i>streets</i> is not more than 135 degrees. Where the said adjacent sides are curved, the angle of intersection of the adjacent sides shall be deemed to be the angle formed by the intersection of the tangents to the <i>street lines</i> , drawn through the extremities of the <i>interior side lot lines</i> . In the latter case, the corner of the <i>lot</i> shall be deemed to be that point on the <i>street line</i> nearest to the point of intersection of the said tangents.
LOT COVERAGE	Means that percentage of the <i>lot area</i> of a <i>lot</i> covered by all <i>buildings</i> and <i>structures</i> , excluding balconies, canopies and overhanging eaves which are two (2) metres or more in <i>height</i> above finished <i>grade</i> . For the purpose of this definition, a <i>deck</i> attached to a <i>building</i> and a covered <i>porch</i> shall be considered in the calculation of <i>lot coverage</i> . <i>Patios</i> shall not be included within the <i>lot coverage</i> calculation.
LOT DEPTH	Means: <ul style="list-style-type: none"> a) the shortest horizontal distance between the <i>rear lot line</i> and the <i>front lot line</i> of a <i>lot</i>, where such <i>lot lines</i> are parallel; or b) the average horizontal distance between the <i>rear lot line</i> and the mid-point of the <i>front lot line</i> of a <i>lot</i>, where such <i>lot lines</i> are not parallel; or

SECTION 3: DEFINITIONS

Term	Definition
	<p>c) the horizontal distance between the mid-point of the <i>front lot line</i> and the point of intersection</p> <p>d) of the <i>side lot lines</i> of a <i>lot</i>, where there is no <i>rear lot line</i>; or</p> <p>e) In the case of flag <i>lots</i> the width of the “pole” or portion of the <i>lot</i> only <i>used</i> for access to the remainder of the <i>lot</i> shall be ignored in determining the midpoint of both the front and <i>rear lot lines</i>.</p>
LOT FRONTAGE	<p>Means the horizontal distance between the <i>side lot lines</i> of a <i>lot</i>, such distance being measured as:</p> <p>a) where the <i>side lot lines</i> are parallel, the distance between the <i>side lot lines</i> measured at right angles; or,</p> <p>b) where the <i>side lot lines</i> are not parallel, the length of a line drawn between the <i>side lot lines</i> parallel to the <i>front lot line</i> at the minimum required <i>front yard setback</i>; or,</p> <p>c) where the <i>side lot lines</i> are not parallel and where the <i>front lot line</i> is curved, the length of a line drawn between the <i>side lot lines</i> back from and parallel to the chord of the <i>lot frontage</i> at the minimum required <i>front yard setback</i>. The chord of the <i>lot frontage</i> is a straight line joining the two points where the <i>side lot lines</i> intersect the <i>front lot line</i>.</p>
LOT, INTERIOR	Means a <i>lot</i> other than a <i>corner lot</i> or a <i>through lot</i> .
LOT LINE	Means any boundary of a <i>lot</i> .
(i) FRONT LOT LINE	<p>Means:</p> <p>a) In the case of an <i>interior lot</i>, the <i>street line</i> of the <i>lot</i>;</p> <p>b) In the case of a <i>corner lot</i>, the <i>lot line</i> used for the principal <i>entrance</i> to the <i>lot</i> shall be deemed to be the <i>front lot line</i>.</p> <p>c) In the case of a <i>through lot</i>, the <i>lot line</i> used for the principal <i>entrance</i> to the <i>lot</i> shall be deemed to be the <i>front lot line</i>.</p>
(ii) REAR LOT LINE	Means, in the case of a <i>lot</i> having four (4) or more <i>lot lines</i> , the <i>lot line</i> farthest from and opposite to the <i>front lot line</i> , except that where a <i>lot</i> has only three (3) <i>lot lines</i> there shall be deemed to be no rear lot line.
(iii) SIDE LOT LINE	Means a <i>lot line</i> other than a <i>front</i> or <i>rear lot line</i> .
(iv) EXTERIOR SIDE LOT LINE	Means a <i>side lot line</i> that abuts a <i>street</i> .

SECTION 3: DEFINITIONS

Term	Definition
(v) INTERIOR SIDE LOT LINE	Means a <i>side lot line</i> other than <i>front, exterior or rear side lot line</i> .
LOT, THROUGH	Means a <i>lot</i> other than a <i>corner lot</i> bounded on two sides by a <i>street</i> .
LOT OF RECORD	Means a <i>lot</i> that legally existed at the date of passing of this By-Law.
LUMBER MILL OR SAWMILL	Means a <i>lot, building or structure</i> where logs of wood are cut into boards and sold at wholesale or retail.
MAIN OR PRINCIPAL	Means the primary <i>use</i> of a <i>lot, buildings or structures</i> .
MANUFACTURING FACILITY	<p>Means a <i>building or structure, used</i> for assembling, fabricating, finishing, inspecting, making, processing, producing, treating or repairing, items either by hand or through the use of machinery, but does not include a <i>food processing plant</i>.</p> <p>A manufacturing facility may include the temporary on-site storage of <i>commercial vehicles</i> for freight handling including the pick-up, delivery and transitory storage of goods incidental to motor freight shipment directly related to the permitted <i>use(s)</i>.</p>
MANSE OR PARSONAGE	Means a <i>dwelling unit</i> for an employee of a <i>place of worship</i> on the same <i>lot</i> as the <i>place of worship</i> is located.
MEDICAL MARIJUANA PRODUCTION FACILITY	Means a <i>lot, building or structure used</i> for producing, processing, testing, destroying, packaging and shipping of Medical Marijuana authorized by a license issued by the federal Minister of Health, pursuant to the Marijuana for Medical Purposes Regulations, under the Controlled Drugs and Substances Act.
MINERAL AGGREGATE OPERATION	<p>Means:</p> <ul style="list-style-type: none"> a) lands under license or permit, other than for <i>wayside pits and quarries</i>, issued in accordance with the Aggregate Resources Act; b) for lands not designated under the Aggregate Resources Act, established <i>pits</i> and quarries that are not in contravention of municipal zoning by-laws and including adjacent land under agreement with or owned by the operator, to permit continuation of the operation; and c) associated facilities <i>used</i> in extraction, transport,

SECTION 3: DEFINITIONS

Term	Definition
	beneficiation, processing or recycling of mineral aggregate resources and derived products such as asphalt and concrete, or the production of secondary related products or any related <i>accessory uses</i> .
MINERAL AGGREGATE RESOURCE CONSERVATION	Means: a) the recovery and recycling of manufactured materials derived from mineral aggregates (e.g. glass, porcelain, brick, concrete, asphalt, slag, etc.), for re-use in construction, manufacturing, industrial or maintenance projects as a substitute for new mineral aggregates; and b) the wise use of mineral aggregates including utilization or extraction of on-site mineral aggregate resources prior to development occurring.
MINIMUM DISTANCE SEPARATION GUIDELINES	Means formulae and guidelines developed by the Province, as amended from time to time, to separate <i>livestock</i> operations from other land <i>uses</i> so as to reduce incompatibility concerns about odour from <i>livestock facilities</i> and manure storage.
MOBILE HOME	Means a prefabricated <i>building</i> designed to be made mobile whether the running gear is removed or not and manufactured to provide cooking, eating, living, sleeping and sanitary facilities constructed to Canadian Standards Association (CSA) and which is designed to be <i>used</i> as a place of residence.
MOTOR HOME	Means a self-propelled <i>recreational vehicle</i> designed in accordance with Canadian Standards Association (CSA).
MUNICIPAL DRAIN	Means drainage works constructed and maintained under the provisions of The Drainage Act.
MUSEUM	Means a <i>building used</i> for the preservation, storage and presentation of works of art, or cultural or historical or scientific objects and information and open to the recreation and education of the public. A <i>museum</i> may also include <i>library</i> , reading rooms, laboratories, storage areas, offices and retail sales as an <i>accessory use</i> .
MUSHROOM OPERATION	Means a business involved in the growing, sorting and/or storing of mushrooms and mushroom-related compounds.

SECTION 3: DEFINITIONS

Term	Definition
MUTUAL DRIVEWAY	Means a <i>driveway</i> benefitting the owners of two or more adjoining properties, intended to provide vehicular access between a <i>street</i> or a <i>lane</i> and a <i>parking space</i> and is considered as a <i>right-of-way</i> registered against the title of the lands.
NATURAL HERITAGE	Means the land that has been identified by the <i>Conservation Authority</i> or the Ministry of Natural Resources and Forestry as significant habitat of endangered species and threatened species; significant woodlands; significant valleylands; significant areas of natural and scientific interest; significant <i>wetlands</i> ; <i>hazardous sites</i> and <i>flooding hazard</i> or steep slope/erosion hazard.
NON-CONFORMING	Means an <i>existing use, building or structure</i> permitted that does not meet the standards, provisions and regulations of this By-Law, but was <i>legally</i> established, <i>erected</i> or <i>altered</i> in accordance with the By-Law in force at the time.
NURSERY AND GARDEN CENTRE	Means the <i>use of lot, buildings or structures</i> , where trees, shrubs or plants are grown or stored for the purpose of transplanting or grafting, or for the purpose of retail or wholesale trade. A <i>nursery and garden center</i> may include the sale of soil, planting materials, fertilizers, garden equipment, ornaments and similar materials as an <i>accessory use</i> .
NURSING HOME	Means, as defined in the Nursing Homes Act any premises maintained and operated for people requiring nursing care or in which such care is provided to two (2) or more unrelated people, but does not include any premises falling under the jurisdiction of, the Charitable Institutions Act, the Child and Family Services Act, the Homes for the Aged and Rest Homes Act, the Private Hospitals Act, or the Public Hospitals Act.
OFFICE, BUSINESS OR PROFESSIONAL	Means a <i>building</i> in which administrative or management functions of an agency, business, service industry, government or any organization are carried out and includes offices such as, but not limited to, a lawyer, a planner, an architect, a surveyor, an engineer, insurance agent, or a chartered accountant, but does not include a <i>personal service establishment</i> , support office, <i>medical office</i> , animal hospital, <i>veterinary clinic</i> , a body-rub parlour or any <i>adult entertainment parlour</i> . A business or professional office may include <i>accessory services</i> for office workers such as a coffee shop.

SECTION 3: DEFINITIONS

Term	Definition
OFFICE, MEDICAL	Means a <i>building used</i> for consultation, diagnosis, and/or treatment of patients by licenced medical practitioners including but not limited to family physician, psychiatrist, acupuncturist, dentist, optometrist, chiropractor or osteopath or as stated in the Regulated Health Professions Act, but shall not include overnight accommodation for in-patient care, or facilities for laboratories, dispensary, surgical procedures which require hospitalization.
OFFICE SUPPLY OUTLET	Means a <i>retail store</i> devoted to wholesale and retail sale of office supplies and <i>school</i> supplies, not limited to paper products, information processing supplies, office furniture, office machines, such as computers, calculators, printers etc.
OFFICE, SUPPORT	Means a <i>building</i> , or part thereof, in which technical or professional consulting services are performed as an <i>accessory</i> to the <i>main</i> employment or commercial <i>use</i> but does not include <i>personal service establishment</i> , lawyer's office, chartered accountant's office, <i>medical clinic</i> , <i>medical office</i> , or animal hospital.
0.3 METRE RESERVE	Means a narrow strip of land, owned in fee simple by the County, traditionally 0.3 metre in width, reserved for the purpose of restricting access.
OPEN STORAGE	Means the storage of raw products or finished goods, equipment or other materials in an area of a <i>lot</i> which is not enclosed within a <i>building</i> or <i>structure</i> and includes <i>vehicles</i> for display, hire or sale.
PAPER PRODUCTS INDUSTRY	Means the <i>use</i> of a <i>lot</i> , <i>building</i> or <i>structure</i> for a pulp and paper industry; the asphalt roofing industry; the paper box and bag industry; and other converted paper products industries but does not include a <i>recycling facility</i> .
PARK	Means an area of land consisting of open space and <i>used</i> primarily for active or passive recreational purposes or as a conservation area, which may include recreational <i>buildings</i> , <i>structures</i> , or facilities including recreation areas, playgrounds, play fields, rinks, walkways, seating areas, picnic areas, special areas of historic, natural, or architectural significance, racquet facilities, a bowling green, a tennis or badminton court, ski facilities, race tracks, pools, and other similar <i>uses</i> , but shall not include an <i>amusement park</i> .

SECTION 3: DEFINITIONS

Term	Definition
PARK, PRIVATE	Means a <i>park</i> other than a <i>public park</i> , regardless of whether or not such <i>park</i> is maintained or operated for gain or profit.
PARK, PUBLIC	Means a <i>park</i> owned or controlled by a <i>public agency</i> .
PARK MODEL TRAILER	<p>Means a recreational unit, manufactured in accordance with Canadian Standards Association (CSA Z-241) that meets the following criteria:</p> <ul style="list-style-type: none"> a) it is built on a single chassis mounted on wheels; b) it is designed to facilitate relocation from time to time; c) it is designed as living quarters for seasonal camping and may be connected to those utilities necessary for operation of installed fixtures and appliances; and, d) it has a gross floor area, including lofts, not exceeding 50 square metres when in the set-up mode and has a width greater than 2.6 metres in a transit mode.
PARKING AREA	Means an area or <i>structure</i> other than a <i>street</i> or a <i>lane</i> , including a <i>private garage</i> , provided for the parking of <i>vehicles</i> , and includes any related <i>aisles</i> , <i>parking spaces</i> and <i>structures</i> , but does not include the storing of impounded, wrecked and/or otherwise inoperable <i>vehicles</i> .
PARKING LOT	Means a <i>lot</i> which is primarily <i>used</i> for the temporary parking of licensed <i>vehicles</i> , and is available for public and/or <i>private use</i> , whether or not such <i>parking area</i> is located within a <i>structure</i> , but does not include a <i>salvage yard</i> .
PARKING SPACE	Means an area, exclusive of <i>aisles</i> , to be <i>used</i> for the parking or temporary storage of a licenced motor <i>vehicle</i> .
PATIO	Means an uncovered, surfaced, open space of land at <i>grade</i> , <i>accessory</i> to a residential or non-residential <i>building</i> , having a <i>height</i> of up to 0.6 metres measured from the lowest point of <i>grade</i> , which is intended for <i>use</i> as an outdoor recreation area but shall not include pathways or walkways.
PATIO, OUTDOOR	Means an outdoor eating area <i>used</i> only on a seasonal basis in conjunction with a <i>restaurant</i> , where seating accommodation is provided and where meals or refreshments are served to the public for consumption on the premises and which is located entirely within the owner's property limits.

SECTION 3: DEFINITIONS

Term	Definition
PERSON	Means an individual, association, firm, partnership, corporation, trust, organization, trustee or agent, and the heirs, executors, or legal representatives of a person to whom the context can apply according to law.
PERSONAL SERVICE ESTABLISHMENT	Means a <i>building</i> in which services are provided and administered to the individual and personal needs of <i>persons</i> , and without limiting the generality of the foregoing, includes a barber shop, beautician, hair salon, shoe repair, tailor shop, <i>dry cleaning and laundromat</i> . The sale of merchandise shall be permitted only as an <i>accessory</i> use to the personal service provided.
PHARMACY	Means a <i>retail store</i> which dispenses prescription drugs and which sells, non-prescription medicines, and associated sundry items such as health and beauty products.
PIT	Means a pit as defined in the Aggregate Resources Act.
PLACE OF WORSHIP	Means a <i>building</i> , owned or occupied by a religious congregation or religious organization and dedicated to worship and related religious, social and charitable activities, with or without a hall, <i>auditorium</i> , convent, monastery, office of a clergyman, <i>cemetery</i> , church school, <i>manse</i> , parish hall, <i>day care</i> or a <i>parsonage</i> as <i>uses accessory</i> thereto.
PLANTING STRIP	<p>Means an area of <i>landscaped open space</i> located immediately adjacent to a <i>lot line</i> or portion thereof, on which one (1) or more of the following screening devices may be located:</p> <ul style="list-style-type: none"> a) a continuous row of trees or shrubs; b) a <i>berm</i>; or c) an opaque fence, <p>and arranged in such a way as to form a dense or opaque screen.</p> <p>The remainder of such planting strip shall be <i>used</i> for no purpose other than landscaping features, trees, shrubs, flowers, grass or similar vegetation.</p>
PORCH OR VERANDAH	Means a <i>structure</i> abutting a <i>dwelling</i> which is permanent, roofed and at least 50% unenclosed, excluding removable screens, storm sashes and awnings and is <i>used</i> for outdoor living space.

SECTION 3: DEFINITIONS

Term	Definition
PORTABLE ASPHALT PLANT	<p>Means a <i>lot, building or structure</i> for:</p> <ul style="list-style-type: none"> a) with equipment designed to heat and dry aggregate and to mix aggregate with bituminous asphalt to produce asphalt paving material, and includes stockpiling and storage of bulk materials <i>used</i> in the process; and b) which is not of permanent construction, but which is to be dismantled at the completion of the construction project.
PORTABLE CONCRETE PLANT	<p>Means a <i>lot, building or structure</i>:</p> <ul style="list-style-type: none"> a) with equipment designed to mix cementing materials, aggregate, water and admixtures to produce concrete, and includes stockpiling and storage of bulk materials <i>used</i> in the process; and b) which is not of permanent construction, but which is designed to be dismantled at the completion of the construction project.
POULTRY	<p>Means any species of domestic fowl, including, but not limited to, chickens, turkeys, ostriches, emus, rheas, cassowaries, waterfowl and game birds raised for food production, breeding, exhibition or sale.</p>
PRINTING ESTABLISHMENT	<p>Means a <i>building used</i> for blueprinting, lithographing, publishing, engraving, stereotyping or printing and may also include photocopying, computer graphics, reproduction of tapes, films or records.</p>
PRIVATE	<p>Means not "<i>Public</i>".</p>
PROCESSED GOODS INDUSTRY	<p>Means a <i>building used</i> by textiles, leather and rubber industries; plastics and synthetic resins industries; paper and wood products industries; metal products industries; oil and coal by-products industries; and non-metallic products industries.</p>
PROPANE TRANSFER FACILITY	<p>Means a facility licenced under the Ontario Energy Board Act having not more than one storage container and such container shall not have an aggregate propane storage capacity in excess of 155,000 litres and shall not permit retail sale of propane fuel to the public.</p>
PUBLIC	<p>When <i>used</i> in reference to a <i>building, structure, use or lot</i>, means a <i>building, structure, use or lot used</i> by a <i>public agency</i> to provide a service to the public.</p>

SECTION 3: DEFINITIONS

Term	Definition
PUBLIC AGENCY	<p>Means:</p> <ul style="list-style-type: none"> a) the Government of Canada, the Government of Ontario or any municipal corporation; b) any Ministry, department, commission, corporation, authority, board, committee or other agency established by the Government of Canada, the Government of Ontario or any municipal corporation; c) any <i>public utility</i>; or d) Any railway company authorized under The Railway Act.
QUARRY	<p>Means a <i>lot</i> where consolidated rock has been or is being removed by means of an open excavation, and includes the processing thereof including screening, sorting, washing, crushing, and other similar required operations, <i>buildings</i> and <i>structures</i>.</p>
RECREATIONAL ESTABLISHMENT	<p>Means the <i>use</i> of a <i>lot, building or structure</i> designed and intended to accommodate various forms of indoor or outdoor sports and recreation, and shall include but not be limited to, an arena, tennis, squash, handball and badminton courts, <i>assembly hall</i>, billiard or pool room, bingo hall, bowling alley, dance hall, gym or fitness centre, ice or roller rink, indoor racquet courts, indoor swimming pool, indoor playgrounds, but does not include place of entertainment, drive-in theater, <i>campground, recreational trailer parks</i>, paint ball, laser tag or <i>war games</i>. Playing areas for tennis, squash, handball and badminton courts are to be excluded for the purpose of calculating parking requirements.</p>
RECREATIONAL TRAILER PARK	<p>Means a <i>lot used</i> for recreational purposes only and not as a <i>main residential use</i>, providing seasonal overnight or short term accommodation for <i>recreational vehicles</i>. Additions to a <i>recreational vehicles or trailers</i> shall not include <i>habitable rooms</i>. A <i>deck</i> or storage shed of less than ten (10) square metres shall be permitted.</p>
RECREATIONAL VEHICLE	<p>Means a <i>vehicle</i> designed to be <i>used</i> primarily for travel, recreation or vacationing purpose and designed to be driven, towed, transported or relocated from time to time whether or not the <i>vehicle</i> is jacked up or its running gear is removed. A recreational vehicle shall not be used as a <i>principal</i> residence and includes such <i>vehicles</i> commonly known as travel <i>trailers</i>, camper <i>trailers</i>, truck camper, tent <i>trailer</i>, <i>motor homes</i>, <i>park model trailers</i>, <i>boats</i>, snowmobiles and all-terrain vehicles but does not include a <i>mobile home</i>.</p>

SECTION 3: DEFINITIONS

Term	Definition
RECYCLING FACILITY	Means a <i>building</i> or <i>structure</i> intended for the collection, storage, sorting, redistribution and sale of reusable goods and materials and may also include an office facility. A recycling facility shall not include on site processing or manufacturing or <i>energy from waste</i> .
RENOVATION	Means the repair and <i>restoration</i> of a <i>building</i> or a <i>structure</i> to an improved condition but shall not include its replacement.
RESEARCH AND DEVELOPMENT ESTABLISHMENT	Means a <i>building used</i> for scientific and technological research and development including laboratories, plants <i>used</i> to test manufacturing processes for use in production, software development, data processing services and engineering services and includes an agricultural research station.
RESTAURANT	Means a <i>building</i> where food and beverages are prepared and offered to the public for consumption either on or off the premises and includes a dining room.
RESTORATION	Means the reconstruction of a <i>building</i> or <i>structure</i> that has been destroyed by fire or vandalism or by flood or a natural occurrence or an act of God. Restoration does not include the rebuilding and/or replacement of a <i>building</i> intentionally removed or demolished.
RETAIL STORE	Means a <i>building</i> where goods, wares, merchandise, articles or things are stored, offered or kept for retail sale or for rental to the public, but does not include any <i>wholesale establishment</i> or an <i>automotive use</i> .
RETIREMENT LODGE OR RETIREMENT HOME	Means a residence providing accommodation primarily for retired <i>persons</i> or couples where each <i>private</i> bedroom or living unit has a separate <i>private</i> bathroom and separate entrance from a common hall but where common facilities for the preparation and consumption of food are provided, and common lounges, recreation rooms and medical care facilities may also be provided.
RIDING STABLE OR ARENA	Means a <i>building</i> which offers horses for hire, boarding or instruction in horsemanship.
RIGHT-OF-WAY OR EASEMENT	Means any right, liberty or privilege in, over, along or under a defined area of land which the owner of the land, has granted to another party for a specific <i>use</i> , right or purpose, while retaining ownership of the said land. Such area of land is legally described in a registered deed for the provision of <i>private</i> use.

SECTION 3: DEFINITIONS

Term	Definition
ROAD ALLOWANCE	Means land held under <i>public</i> ownership for the purpose of providing a <i>street</i> and/or <i>public</i> infrastructure.
SALVAGE OR SCRAP YARD	Means a <i>lot, building or structure</i> used for the storage wholly or partly in the open, handling, processing, or any combination thereof, of scrap material for reuse for the purpose of commercial gain, which without limiting the generality of the foregoing, shall include waste paper, rags, bottles, bicycles, tires, and metal, and junk or scrap metal yards and <i>vehicle</i> wrecking yards shall also be included. A salvage or scrap yard does not include a <i>recycling facility</i> .
SATELLITE DISH	Means a device designed to receive communication signals from a satellite.
SCHOOL	Means an institution for education or instruction as defined by the Education Act, or the Ministry of Training, Colleges and Universities Act normally under the jurisdiction of a Board, or under the jurisdiction of the Grand Erie District School Board, or the Brant Haldimand-Norfolk Catholic District School Board, or a school operated under charter granted by the Province of Ontario.
SCHOOL, COMMERCIAL	Means a teaching and training center, operated for gain or profit, in which instruction in a trade, skill or service is provided and without limiting the generality of the foregoing, includes <i>studio</i> , administrative skills, vocational skills, aviation, banking, commercial arts, <i>vehicle</i> driving, language, modeling, business, cosmetology, culture, dancing or music.
SCHOOL, ELEMENTARY	Means a <i>school</i> under the jurisdiction of the Grand Erie District School Board, or the Brant Haldimand-Norfolk Catholic District School Board <i>used</i> primarily for the instruction of students receiving primary education.
SCHOOL, MUSIC	Means a <i>building</i> devoted to the teaching of music either instrumental or vocal.
SCHOOL, POST SECONDARY	Means a <i>school</i> under the jurisdiction of a Board as defined in the Ministry of Training, Colleges and Universities Act.
SCHOOL, PRIVATE ELEMENTARY	Means a <i>school</i> , other than a vocational <i>school</i> or a <i>commercial school</i> , under the jurisdiction of a private board of trustees or governors, a religious organization or a charitable institution that is recognized under the Education Act and offers the subjects of the Elementary School course of study and may or may not offer an extended curriculum.

SECTION 3: DEFINITIONS

Term	Definition
SCHOOL, PRIVATE SECONDARY	Means a <i>school</i> , other than a vocational <i>school</i> or a <i>commercial school</i> , under the jurisdiction of a <i>private</i> board of trustees or governors, a religious organization or a charitable institution that is recognized under the Education Act and offers the subjects of the Secondary School course of study and may or may not offer an extended curriculum.
SCHOOL, SECONDARY	Means a <i>school</i> under the jurisdiction of the Grand Erie District School Board or the Brant Haldimand Norfolk Catholic District School Board <i>used</i> primarily for the instruction of students receiving a secondary education.
SERVICE AND RENTAL ESTABLISHMENT	Means a <i>lot, building</i> or <i>structure</i> engaged in maintaining, repairing, installing or renting articles or equipment for household and personal <i>use</i> , and includes a <i>service shop</i> . A service and rental establishment may also include the retail sale of replacement parts for such articles or goods.
SERVICE SHOP	Means a <i>lot, building</i> or <i>structure</i> , other than an <i>automotive use</i> , that provides a non-personal service or craft to the public, including, but not necessarily restricted to, a printer's shop, a plumber's shop, a tinsmith's shop, a painter's shop, a carpenter's shop, an electrician's shop, a welding shop, a blacksmith's shop, a battery storage and recharging shop, a well driller's establishment, a tailor, an upholsterer's shop, an egg grading station, a machine shop or a monument engraving shop but does not include a butcher shop or a <i>bakery</i> .
SETBACK	Means the horizontal distance between the boundary of a <i>lot, parcel</i> or block of land and the nearest point of any <i>building</i> or <i>structure</i> , measured perpendicular to the boundary.
SETBACK, STREET	Means the <i>front yard setback</i> and/or the <i>exterior side yard setback</i> for any <i>lot</i> .
SHIPPING CONTAINER	Means a pre-fabricated metal container or <i>structure</i> having a floor, roof, walls and door(s), and typically six (6) metres to sixteen (16) metres in length, and specifically designed for storage of goods and materials while under transport by <i>boat, truck</i> or rail.

SECTION 3: DEFINITIONS

Term	Definition
SHOPPING CENTRE	Means a <i>lot</i> , a <i>building</i> or <i>buildings</i> containing at least four individual commercial uses (wherein no more than 30% of the gross leasable area is devoted to general offices, <i>medical offices</i> , designed, developed, and managed as a comprehensive development for which common <i>loading spaces</i> , <i>parking areas</i> , landscaping areas, and other common facilities may be provided, and which is held under one ownership or by participants of the <i>condominium</i> corporation or commercial cooperative and where the predominant use is <i>retail stores</i> .
SHORT TERM RENTAL ACCOMMODATION	Shall mean a dwelling unit, or portion thereof, in which temporary accommodation is made available to members of the travelling public for a maximum of 28 consecutive days per stay, and does not include a bed and breakfast establishment, group home, or lodging house.
SIGN	Means any surface, <i>structure</i> and other component parts, which are <i>used</i> or capable of being <i>used</i> as a visual medium to attract attention to a specific subject matter for identification, information or advertising purposes and includes an advertising device or notice.
STACKING LANE	Means an on-site queuing <i>lane</i> that includes <i>stacking spaces</i> for motor <i>vehicles</i> which is separated from other vehicular traffic and pedestrian circulation by barriers, markings, or <i>signs</i> .
STACKING SPACE	Means a rectangular space that may be provided in succession and is designed to be <i>used</i> for the temporary queuing of a motor <i>vehicle</i> in a <i>stacking lane</i> .
STOREY	Means a horizontal division of a <i>building</i> from a floor to the ceiling directly above such floor, and includes an <i>attic</i> or a <i>basement</i> , but does not include any mezzanine, gallery, <i>balcony</i> or other overhang.
STORMWATER MANAGEMENT FACILITY	Means an end-of-pipe, managed detention or retention basin, which may include a permanent pool, designed to temporarily store and treat collected stormwater runoff and release it at a controlled rate or direct it for an intended reuse.
STREET	Means a <i>public</i> highway or <i>public</i> road under the jurisdiction of either the County or the Province of Ontario, and includes any highway as defined in The Municipal Act or The Highway Traffic Act, but does not include <i>private right-of-way</i> or <i>private street</i> .

SECTION 3: DEFINITIONS

Term	Definition
STREET, PRIVATE	Means a <i>private right-of-way</i> or <i>lane</i> for vehicular or pedestrian access that is not owned or maintained by the County or Province of Ontario and includes a <i>right-of-way</i> that is maintained by a corporation created pursuant to the provisions of the Condominium Act.
STREET LINE	Means a <i>lot line</i> of a <i>lot</i> adjoining a <i>street</i> .
STRUCTURE	Means anything constructed or <i>erected</i> , the <i>use</i> of which requires location on or in the ground, or attached to something located on or in the ground, but does not include the permanent way of a railway, any paved surface located directly on the ground, a fence, <i>sign</i> , or light fixtures or inground storage tanks.
STUDIO	Means a <i>building used</i> as the workplace of a photographer, martial arts, artist for the instruction of art, music, dancing, languages or similar disciplines and includes a <i>crafts shop</i> .
TAXI STAND	Means a <i>lot</i> or <i>building used</i> as a dispatch office or an area, site or location intended for the parking of taxis and/or limousines when not engaged in transporting people or goods.
TOP OF BANK	Means, when <i>used</i> with reference to a watercourse, the highest elevation of land which ordinarily confines the waters of such watercourse when they rise out of the stream bed and/or the highest point of a stable slope associated with valley corridors containing a river or stream channel, as determined by the <i>Conservation Authority</i> .
TRAILER	Means a <i>vehicle</i> designed to be towed by a <i>motor vehicle</i> for the purpose of transporting or storage of goods, materials and equipment, including boat and snowmobile trailers.
TRANSPORT/ TRUCK TERMINAL	Means premises <i>used</i> for the transfer of goods primarily involving loading and unloading of freight-carrying trucks, and accordingly, involving the storing, parking, servicing and dispatching of freight-carrying trucks.
USE	Means: a) when used as a noun, the purpose for which a <i>lot</i> , <i>building</i> or <i>structure</i> , is designed, arranged, occupied or maintained; or

SECTION 3: DEFINITIONS

Term	Definition
	b) when used as a verb, the doing or permitting of anything by the owner or occupant of any <i>lot, building or structure</i> directly or indirectly or by or through any trustee, tenant, servant or agent acting for such owner or occupant, for the purpose of making use of the <i>lot, building or structure</i> .
UTILITY	Means any <i>building or structure</i> used for the supply of essential services, including a water or sewage pipeline or pumping station, a water storage reservoir, an electrical substation, a gas regulator, a gas or oil pipeline, electricity generation facilities and transmission and distribution systems, drainage, transportation, communications provided by a regulated company or <i>public agency</i> , and includes the offices and/or equipment <i>used</i> in connection with the utility.
VEHICLE	Means a passenger automobile or other motor vehicle, a <i>boat</i> , a farm implement, a <i>mobile home</i> , a <i>motor home</i> , a snowmobile, a <i>trailer</i> , or any other device which is capable of being drawn, propelled or driven by any kind of power, and includes a <i>commercial vehicle</i> , but does not include a bicycle or any other device powered solely by means of human effort.
VEHICLE, COMMERCIAL	Means a <i>vehicle</i> , as defined in the Highway Traffic Act having permanently attached thereto a truck or delivery body and includes ambulance, food truck, hearse, catering or canteen truck, cube van, casket wagon, school bus, tilt and load truck, dump truck, fire apparatus, bus and tractor <i>used</i> for hauling purposes.
VETERINARY CLINIC	Means a <i>building or structure</i> where animals or birds are given medical treatment under the control of a qualified veterinarian who is a member of the Ontario Veterinary Medical Association. A veterinary clinic may also include <i>accessory</i> services such as grooming, sale of foods, supplies and other goods <i>used</i> by or with animals, but shall not include outdoor runs for long term stays or a <i>kennel or boarding facility</i> .
VISIBILITY TRIANGLE	Means the triangular space formed by the distance between the point of intersection of two <i>lot lines</i> , at least one of which is also a <i>street line</i> , and their respective points of intersection with the line constituting the third side of the triangle shall be calculated in accordance with the <i>County's</i> Development and Engineering Standards and the Transportation Association of Canada. A visibility triangle is commonly called a sight triangle or a daylight triangle.

SECTION 3: DEFINITIONS

Term	Definition
WAR GAMES	Means any form of play, sport or amusement which simulates war, armed conflict or military operations.
WAREHOUSE	Means a <i>building</i> or <i>structure</i> used for the storage and distribution of goods, merchandise, substances, or materials which will be sold elsewhere or, subsequently, transported to another location for sale or consumption. The retail or wholesale sale of products may only be permitted as an <i>accessory use</i> .
WAREHOUSE, PUBLIC SELF-STORAGE	Means a compartmentalized facility or <i>building(s)</i> where individual storage areas are made available to the public on rental for storage of personal goods.
WASTE DISPOSAL SITE	<p>Means:</p> <ul style="list-style-type: none"> a) any land upon, into, in or through which, or <i>building</i> or <i>structure</i> in which, waste is/was deposited, disposed of, handled, stored, transferred, treated or processed, and b) any operation carried out or machinery or equipment <i>used</i> in connection with the depositing, disposal, handling, storage, transfer, treatment or processing referred to in clause (a), and c) any facility processing non-hazardous wastes through recycling, composting, recovery, incineration, and/or landfilling and operating under an Environmental Compliance Approval under the Environmental Protection Act. <p>For the purpose of this By-Law, this definition does not include any facility generating <i>energy from waste</i> or waste incineration.</p>
WASTE TRANSFER STATION	Means a facility operated under the Environment Protection Act where the primary purpose is the collection and storage of waste or hazardous waste for shipment, and which may include limited sorting or preparation of that waste to facilitate its shipment for final disposal or transfer to a waste processing station, but does not include a facility generating <i>energy from waste</i> or <i>salvage yards</i> .
WAYSIDE PIT OR WAYSIDE QUARRY	Means a temporary <i>pit</i> or <i>quarry</i> opened and <i>used</i> by or for a <i>public agency</i> solely for the purpose of a particular project or contract of road construction and not located on the road <i>right-of-way</i> .

SECTION 3: DEFINITIONS

Term	Definition
WETLAND	<p>Means lands that are seasonally or permanently covered by shallow water, as well as lands where the water table is close to or at the surface. In either case the presence of abundant water has caused the formation of hydric soils and has favoured the dominance of either hydrophytic plants or water tolerant plants. The four major types of wetlands are swamps, marshes, bogs and fens.</p> <p>Periodically soaked or wet lands <i>used</i> for agricultural purposes that no longer exhibit wetland characteristics shall not be considered wetlands for the purposes of this definition.</p>
WHOLESALE ESTABLISHMENT	<p>Means a <i>lot</i> or a <i>building</i> where goods and merchandise are sold for resale to other businesses including other wholesalers and/or to industrial and commercial users.</p>
WORKS YARD, MUNICIPAL OR PROVINCIAL	<p>Means the <i>use of lot, buildings, or structures</i> for the storage of municipal or provincial road maintenance equipment and the equipment <i>used</i> to maintain other <i>public</i> facilities and includes facilities for the stockpiling of sand and sand salt mixture or materials <i>used</i> in the maintenance of roads and lands owned by the municipality or province.</p>
YARD	<p>Means an area of land which is open, uncovered, unoccupied and is appurtenant to, and located on the same <i>lot</i> as a <i>building, structure</i> or excavation.</p> <p>In determining yard measurements, the minimum horizontal distance from the respective <i>lot lines</i> to the nearest part of the <i>building</i> shall be <i>used</i>.</p>
(i) FRONT YARD	<p>Means a <i>yard</i> extending across the full width of a <i>lot</i> between the <i>front lot line</i> and the nearest part of any <i>building</i> or <i>structure</i> on such <i>lot</i>.</p>
(ii) REAR YARD	<p>Means a <i>yard</i> extending across the full width of a <i>lot</i> between the <i>rear lot line</i> or, where there is no <i>rear lot line</i>, the junction point of the <i>side lot lines</i>, and the nearest part of any <i>building</i> or <i>structure</i> on such <i>lot</i>.</p>
(iii) SIDE YARD	<p>Means a <i>yard</i> extending from the <i>front yard</i> to the <i>rear yard</i> between the <i>side lot lines</i> and the nearest part of any <i>building</i> or <i>structure</i> on such <i>lot</i>.</p>

SECTION 3: DEFINITIONS

Term	Definition
(iv) EXTERIOR SIDE YARD	Means a <i>side yard</i> immediately adjoining a <i>street</i> or abutting a <i>0.3 meter reserve</i> on the opposite side of which a <i>street</i> is located.
(v) INTERIOR SIDE YARD	Means a <i>side yard</i> other than an <i>exterior side yard</i> .
ZONE	Means a designated area of land <i>use</i> shown on Schedule “A” of this By-Law.

SECTION 4: GENERAL PROVISIONS

4.1 Prohibited Uses

All *uses* are prohibited unless specifically permitted in this By-Law.

4.2 Accessory Uses Permitted in all Zones

Unless otherwise specified, *accessory uses* are permitted in all *Zones* except that no *home occupation, open storage* or *accessory dwelling* shall be permitted in any *Zone* unless specifically listed as a permitted *use*.

An *accessory use* permitted shall be permitted if:

- a) the principle *use, building* or *structure* is already established;
- b) is on the same *lot* as the *use* to which it is *accessory*;
- c) it is not *used* for human habitation except as permitted in the By-Law.

4.3 Connected Structures

When an *accessory building* or *structure* is attached to a *main building* on the same *lot* by a *breezeway* or a roofed passage or an open or enclosed *structure* above *grade* or a floor or foundation which is above *grade* or any similar *structure* below *grade*, the *accessory structure* shall be deemed to be part of the *main building*, and shall maintain the *Zone* requirements of the *main building*.

4.4 Regulations for Accessory Buildings and Structures

- a) *Accessory buildings* having a maximum *gross floor area* of less than 10 square metres may be located in a required *rear yard setback* or a required *interior side yard setback*; provided it is located 0.6 metres from the *lot line*.
- b) *Buildings* or *structures* *accessory* to a *dwelling unit* shall not be permitted prior to the construction of the *dwelling* and shall not be located in the *front yard* or *exterior side yard*.
- c) The cumulative *floor area* of all *buildings* and *structures* shall not exceed the allowable *lot coverage* for the *Zone*.
- d) *Decks* that have a *height* of less than 0.6 metres above *grade* shall be permitted in any required *rear yard, exterior side yard* or *interior side yard* and shall not be subject to *setback* requirements.
- e) In an Agricultural or Agricultural Employment *Zone*, the *gross floor area* of the *accessory buildings* incidental to a *dwelling* shall not exceed 75% of the *gross floor area* of the *dwelling*.

SECTION 4: GENERAL PROVISIONS

- f) The *height* of *accessory farm buildings and structures* in an Agricultural or Agricultural Employment Zone shall comply with the *height* requirements applicable to the *Zone*, except for an *accessory building* incidental to a *dwelling* in an Agricultural or Agricultural Employment Zone.

Table 4.1 Accessory Use Regulations

Regulations	Urban Residential Zones	All other Residential Zones	Accessory to a Dwelling in Agricultural Zones	All other Zones
<i>Lot Coverage, Maximum</i>	15%	15%	10%	In accordance with the zone provisions
<i>Gross Floor Area of Accessory Building or Structure, Maximum (square metres)</i>	95	140	Upto a maximum of 75% of the <i>gross floor area</i> of the <i>Dwelling</i>	95
<i>Interior Side Yard Setback, Minimum (metres)</i>	1.2	1.5	3	3*
<i>Rear Yard Setback,, Minimum (metres)</i>	1.2	1.5	3	3*
<i>Building Height, Maximum (metres)</i>	4.5	5.0	5.0	5.0

* *Notwithstanding the requirements above, where a lot line abuts any Residential Zone, setbacks for accessory use shall be provided in accordance with the main use.*

4.5 Accessory Dwelling Units

Accessory Dwelling Units shall be permitted within a single detached dwelling, semi-detached dwelling, and rowhouse dwelling and located on the same lot as the principal dwelling, subject to the following provisions:

- a) Number Permitted: Two (2) provided that the main residential dwelling on the lot shall not contain more than one (1) accessory dwelling unit, and no more than one (1) Accessory Dwelling Unit shall be located in an accessory building. Only one Accessory Dwelling Unit is permitted if the lot contains a legally established garden suite or a mobile home and it shall be located within the main dwelling.
- b) Maximum Floor Area: 93 square meters.

SECTION 4: GENERAL PROVISIONS

- c) Location Requirements: An Accessory Dwelling Unit shall be located in conformity with the yard requirements of the Zone.
- d) Unenclosed Access/Egress: No Accessory Dwelling Unit or portion thereof shall provide for access and egress by means of an unenclosed stairway or fire escape.
- e) Parking for Accessory Dwelling Units must be provided on the same lot as the unit and can be provided as tandem parking.
- f) Servicing: The lot must be fully serviced and servicing capacity must be available to the satisfaction of the City.

4.6 Day Care Regulations in Commercial and Employment Zones

A *day care*, where permitted in Commercial or Employment Zones, shall comply with the following regulations:

- a) No portion of a *day care* including on-site outdoor play space shall be located within 50.0 metres of any *automotive use*.
- b) Parking shall be provided according to the regulations outlined in Section 5 of this By-Law. In addition, drop-off parking shall be provided as follows:
 - (i) a separate on-site drop-off area shall be provided at the rate of 2 drop-off spaces for up to 10 children, plus 1 additional space for every 10 additional children;
 - (ii) each drop-off space shall be a minimum of 2.6 metres in width and a minimum of 5.5 metres in length; and
 - (iii) the drop-off area shall be located within 60.0 metres from the main entrance of the *day care* facility.
- c) Exterior lighting of the facility shall provide for a well-lit environment;
- d) Where on-site outdoor play space is provided, it shall comply with the following regulations:
 - (i) noisy, noxious or hazardous adjacent *uses* such as, but not limited to, loading/unloading areas, garbage bins, large *parking lots*, arterial roads, passenger drop-off areas, rail lines, or storm water management pond should either be avoided or their effects mitigated through landscaping, buffering, fencing, or other means;
 - (ii) outdoor play space shall be located at ground level and shall be securely enclosed on all sides;

SECTION 4: GENERAL PROVISIONS

- (iii) the outdoor play space shall not be located in any *yard* that abuts a *public street* unless it is fenced to the satisfaction of the County.

4.7 Daylight Corners/ Visibility Triangles

Notwithstanding any other provisions of this By-Law, no *buildings* or *structures* or any *yard* encroachments, including a fence, *sign* or *driveway*, shall be permitted within a *visibility triangle* and no shrubs, foliage, *berm* or any landscaping materials shall be planted or maintained which exceed a *height* of 0.6 metres above the centreline *grade* of the intersecting *streets*.

4.8 Drive-Through Facilities

Drive-through facilities are subject to the following provisions:

- a) Where *drive-through facilities* are permitted, *stacking lanes* are required and shall be exclusive of any other *parking space* and *loading space* and *aisle* or *driveway* requirements contained within this By-Law and shall be provided in accordance with the provisions of this section.
- b) No *drive-through facilities* including drive through *lanes* and all order boxes using voice communication to order shall be permitted closer than 15 metres to any *lot line* where the abutting *lot* contains a residential *use*.
- c) The distance between the closest *driveway* access and the last *stacking space*, measured in a straight line from the middle point of the *driveway* at the *lot line*, shall be 15.0 metres.
- d) The *stacking lane* shall have a minimum width of 3 metres.
- e) The *stacking space* shall have a minimum length of 5 metres.
- f) The minimum *stacking space* requirements within a designated *stacking lane* shall be as described in the following table:

Table 4.2 Stacking Space Requirements

Use Associated with Drive-through Facility	Minimum Required Ingress Spaces
<i>Restaurant or any Eating Establishment</i>	12
<i>Automobile Service Station</i>	3
<i>Car Wash</i>	10
<i>Financial Institution and all other uses</i>	5

SECTION 4: GENERAL PROVISIONS

Use Associated with Drive-through Facility	Minimum Required Ingress Spaces
School, Elementary or Secondary	10

- g) Required ingress *stacking spaces* shall be located and calculated from 2.0 meters in front of the product pick-up window or dispensing machine. The *stacking spaces* at the product pick-up window shall count towards the minimum ingress *stacking spaces*.
- h) The length of the *stacking lane* associated with the *drive-through facility* shall be the total number of required ingress *stacking spaces*.
- i) Where multiple *stacking lanes* are provided on a *lot*, the *stacking space* requirements shall be provided for each individual *stacking lane* in compliance with the Table 4.2 of this By-Law.
- j) *Stacking lanes* shall be unobstructed and shall be clearly delineated by pavement markings or physical barriers, and shall be independent of the balance of the *parking area* and loading area.
- k) No *stacking lanes*, order boxes and wall openings associated with a *drive-through facility* shall be located in the required minimum *front yard* or *exterior side yard* unless there is a landscaping buffer of 3 metres.

4.9 Dwelling Units

- a) The minimum *gross floor area* for all types of *dwelling units* other than an *apartment dwelling* or a *farm labour housing* shall be 70 square metres and for a *mobile home* or a *garden suite*, the minimum *gross floor area* shall be 45 square metres.
- b) One *dwelling unit* per *lot* shall be permitted, unless otherwise permitted, except in the case of:
 - (i) a *lot* containing more than one (1) *dwelling unit legally* established on the date of passing of this By-Law, or
 - (ii) a replacement *dwelling* for a period not to exceed 90 days, provided a Demolition Permit has been issued by the County and an Agreement is entered into with the County and securities are held to ensure the demolition of the *existing* house.
 - (iii) Model home in accordance with Section 4.26 of the By-Law.

SECTION 4: GENERAL PROVISIONS

4.10 Farm Production Outlet Regulations

Table 4.3 Farm Production Outlet Regulations

Regulations	Setbacks
Minimum <i>Street Setback</i>	a) 15 metres for a permanent <i>building</i> ; b) 7.5 metres for a portable <i>building</i> that is removed at the end of the season.
Minimum <i>Interior Side Yard Setback</i>	7.5 metres
Minimum <i>Rear Yard Setback</i>	15 metres
Maximum <i>Building Height</i>	6 metres
Maximum <i>Floor Area</i> devoted to <i>Farm Production Outlet</i>	60 sq. m.
Parking	Must be contained on the <i>lot</i> according to the provisions of this By-Law

4.11 Garden Suites

A *garden suite* may be located on a *lot* in any Urban Residential Zone or Non-Urban Residential Zone or Agricultural Zone or Agricultural Employment Zone through the passage of a Temporary Use By-Law under the provisions of Planning Act, subject to the following:

- a) One (1) *garden suite* shall be permitted on a *lot* provided the *lot* does not contain an *accessory dwelling unit* and shall comply with the provisions of the *Zone*.
- b) One (1) *parking space* shall be provided for the *garden suite* in addition to the parking required for other *uses* on the *lot*.

4.12 Greenhouse Regulations

A *farm greenhouse* or a *commercial greenhouse* or a combination of both, having a *gross floor area* greater than 500 square metres shall not be permitted unless a Site Plan Agreement has been entered into with the County regarding stormwater management, lighting and other details as required by the County. A *farm greenhouse* or a *commercial greenhouse* shall be permitted in accordance with following regulations:

SECTION 4: GENERAL PROVISIONS

Table 4.4 Greenhouse Regulations

Provisions	Specifications
Street Setback, Minimum (metres)	15
Interior Side Yard Setback and Rear Yard Setback, Minimum (metres)	6 metres, except: a) where the <i>yard</i> abuts a residential use, 25 metres is required, b) where ventilating fans exhaust into the <i>yard</i> facing the residential use, 25 metres is required, c) where artificial lighting is used for growing purposes, 150 metres is required.
Lot Coverage, Maximum	70%
Building Height, Maximum (metres)	5
Landscaped Open Space, Minimum	A landscaping area in the form of a 3 metres wide <i>planting strip</i> shall be provided and maintained adjacent to the any <i>lot line</i> that abuts a Residential Zone or residential use.
Open Storage	<i>Open storage</i> of goods, materials or supplies is permitted in the <i>rear yard</i> or <i>interior side yard</i> , provided it is screened from any <i>street</i> or a residential use.
Other Regulations	No manure, compost or equipment related to, may be stored within 30 metres of a <i>road allowance</i> , or a watercourse, or a residential use on an adjacent <i>lot</i> .

4.13 Group Homes

Notwithstanding any other provisions of this By-Law to the contrary, *group homes* are permitted only within a *single detached dwelling or semi-detached dwelling* in those *Zones* which specifically permit the *use*.

The minimum *floor area* required for a *group home* shall be 18.5 sq.m. per *person* unless a greater *floor area* is required for the *Zone* in which said *use* is located.

4.14 Height and Density Bonus Provisions

Notwithstanding the *height* and *density* provisions which apply to a *lot*, the maximum permitted *height* and/or *density* may be increased in accordance with the provisions set out in this section on having entered into an Agreement with the County under Section 37 of the Planning Act.

SECTION 4: GENERAL PROVISIONS

4.15 Height Restrictions

4.15.1 General

The following *structures* are exempt from the *height* restrictions of this By-Law:

- a) barn or silo for an *agricultural use*;
- b) *grain elevator and drying facility*;
- c) chimney;
- d) clock tower;
- e) flag pole;
- f) hydro tower;
- g) minarets or monuments;
- h) ornamental features, provided it is not *used* for signage;
- i) radio, television or telecommunications antenna or tower;
- j) steeple, spire, belfry or cupola;
- k) *structures* for heating, cooling, or other mechanized equipment attached to a *building*, or a *structure* containing such equipment or containing elevator equipment or a stairway to the roof;
- l) water tower, precipitating tower or cracking tower;
- m) wind turbine or windmill;
- n) parapet wall or similar structural element.

4.15.2 Brantford Municipal Airport Height Restrictions

Notwithstanding Section 4.15.1 above, all *development* within the area affected by the ground surface projection of the Brantford Municipal Airport Obstacle Limitation Surface shall comply with the *height* restrictions as shown on Schedule “B” of this By-Law.

4.15.3 Brantford Municipal Airport Protection Overlay

The Brantford Municipal Airport Protection Overlay shall apply to all lands within the Brantford Municipal Airport Protection Overlay Zone as shown on Schedule “C” of this By-Law.

Any development within the Brantford Municipal Airport Protection Overlay as shown on Schedule “C” shall require a noise study to be completed by a qualified professional and approvals from Transport Canada.

SECTION 4: GENERAL PROVISIONS

4.16 Home Occupation

A *home occupation* shall be permitted in an *Agricultural Zone*, *Urban Residential Zone* and *Non-Urban Residential Zone* only as an *accessory use* to a residential use, in accordance with the following provisions:

4.16.1 Location and Residential Character

- a) The residential appearance and character of the *dwelling* and the *lot* shall be maintained and no exterior *alteration* shall be made to the *dwelling* which would indicate that any part of the premises is being *used* for any purpose other than that of a residential *dwelling*.
- b) A *home occupation* shall be clearly secondary and incidental to a *dwelling* occupied by the owner or tenant as his *main* residence.
- c) A *home occupation* shall only be permitted within the residential *dwelling* except in *Agricultural (A) Zone*, *Rural Residential (RR) Zone* and *Residential Hamlets and Villages (RH) Zone*, the *home occupation* may be located within a *building* or *structure* which is *accessory* to the *main* residential or *agricultural use*.
- d) Notwithstanding anything in this By-Law to the contrary, a maximum of two *home occupations* otherwise permitted in this section may be permitted within one *dwelling unit* provided the two *home occupations* cumulatively do not exceed the *gross floor area* requirements for *home occupations* as set out herein.

4.16.2 Parking

An additional *parking space*, in accordance with this By-Law, shall be provided for each *home occupation* in addition to those required by the By-Law for other permitted *uses* on the *lot*.

4.16.3 Size

- a) No more than twenty-five percent (25%) of the *gross floor area* of the *dwelling unit* may be devoted to a *home occupation use*, to a maximum of 45 square metres.
- b) The *gross floor area used* for a *home occupation* shall not reduce the *dwelling area* required by this By-Law except that a *bed and breakfast establishment* or a *private home day care* may be larger than 45 square metres.
- c) The *gross floor area for the home occupation* if located within *accessory building* shall not exceed 10% coverage of the *lot area* or a total of 300 square metres of *floor area* of the *building*, whichever is the lesser.

SECTION 4: GENERAL PROVISIONS

4.16.4 Nuisance

- a) No residential *home occupation* shall create or become a public nuisance, particularly with regard to noise, odour, fumes, vibration, traffic, emissions or parking nor shall it cause electrical interference or interference with telephone, television, and radio or satellite equipment reception.
- b) The *home occupation* shall not create or become a fire, health or *building* hazard.

4.16.5 Employees/Customers

- a) Any *home occupation* in any Urban Residential *Zone* or Non-Urban Residential *Zone* shall not employ anyone at any time.
- b) No more than two (2) people who do not reside on the *lot* may be employed by the *home occupation* in an Agricultural *Zone*.
- c) The *home occupation* shall not involve the *use* of the premises as a base of operations for people who are employed by or associated with the *home occupation*, nor shall the premises be *used* to assemble or rally such people for transportation to a work site.
- d) No more than two (2) clients, customers or students shall be serviced at any one time.

4.16.6 Storage and Display

- a) *Open storage* or display of merchandise, material or equipment is prohibited.
- b) Merchandise may be displayed within the *dwelling or accessory building* provided it shall not be visible from outside the *dwelling or accessory building where it is displayed*.
- c) Merchandise, material and equipment shall be stored within an *attached or detached garage* or other *accessory building* provided it shall not be visible from outside.
- d) External advertising is prohibited except in accordance with the County's Sign By-Law.

4.16.7 Retail Sales

Any *gross floor area* used for retail sales shall be no more than 10% of the *gross floor area* of the *home occupation* and shall generally include goods related the *home occupation* or manufactured as a part of the *home occupation*.

SECTION 4: GENERAL PROVISIONS

4.16.8 Uses Permitted and Prohibited

- a) *Home occupations* shall be limited to the following occupations:
- (i) *Bed and breakfast establishment* subject to Section 4.16.9;
 - (ii) Caterer's establishment;
 - (iii) Computer services;
 - (iv) *Crafts Shop*;
 - (v) Instruction of music, arts, academic subjects;
 - (vi) Insurance and/or sales agents;
 - (vii) *Office, Business or Professional*;
 - (viii) *Medical Office* limiting the use to physiotherapist, osteopathic, chiropractor, massage therapist limited to only one practitioner. This shall not include dentists, laboratory, *pharmacy* or a dispensary;
 - (ix) *Personal service establishment*;
 - (x) *Private home day care*;
 - (xi) Seamstress/tailor;
 - (xii) *Studio*.
- b) None of the following *uses* shall be considered *home occupations*, except where such *uses* are specifically permitted:
- (i) *hospital*;
 - (ii) *funeral home*;
 - (iii) *restaurant*;
 - (iv) medical/dental office;
 - (v) *salvage yard*;
 - (vi) *automotive use*;
 - (vii) *open storage*;
 - (viii) *veterinary clinic*.

4.16.9 Bed and Breakfast Establishment

Where permitted, the following regulations apply for a *bed and breakfast establishment*.

- a) A *bed and breakfast establishment* is only permitted within a *single detached dwelling*.

SECTION 4: GENERAL PROVISIONS

- b) The *bed and breakfast establishment* shall have a maximum of three bedrooms for booking which shall in total not exceed a maximum of 25% of the *gross floor area* of the *single detached dwelling*.
- c) The *bed and breakfast establishment* shall be operated by the *owner/owners* residing in the same *dwelling* in which the *bed and breakfast establishment* is located.
- d) The parking for the *bed and breakfast establishment* must be provided on the same *lot* in accordance with Section 5.12 of this By-Law and must be in addition to the parking requirements for the *main dwelling* and may be in tandem with the required parking for the *main dwelling*.

4.17 Household Sales/Garage Sales/Auction Sales

- a) *Household sales/garage sales* are permitted in an *Agricultural Zone*, *Urban Residential Zone* or *Non-Urban Residential Zone*, except that there shall not be more than two such sales per annum at any location and no such sale shall exceed three consecutive days in duration.
- b) Auction sales to dispose of any goods or materials that have been normally and regularly *used* in the operation of a business or enterprise on the same *lot* as the sale, are permitted in any *Agricultural Zone*, *Agricultural Employment Zone*, *Commercial Zone*, *Institutional Zone* or *Employment Zone*, except that there shall not be more than one such sale per annum per location and no such sale shall exceed three consecutive days in duration.

4.18 Landscaped Open Space and Planting Strips

Landscaped open space shall be provided in accordance with the *Zone* provisions for each *Zone* and the following general provisions:

- a) Any part of a *lot* which is not occupied by *buildings, structures, parking areas, loading spaces, driveways, excavations, agricultural use* or permitted outdoor storage areas shall be maintained as *landscaped open space*.
- b) Where a *lot* in a *Commercial Zone* or *Employment Zone* abuts any *lot line* of any *Residential Zone* or *Institutional Zone* or abuts a *street* the opposite side of which is any *Residential Zone* or *Institutional Zone*, then a minimum of a 3 metres strip of land on that *lot* shall be *used* only for the purpose of a *planting strip* at least 1.8 metres in *height*.
- c) All required and approved landscaping features, including screens and buffers, shall be suitably maintained by the property owner in a neat and tidy condition, at all times, including adjacent boulevard areas where applicable.
- d) Landscaping requirements in any *Residential Zones* shall be:

SECTION 4: GENERAL PROVISIONS

- (i) The *landscaped open space* in any Residential Zones may include any part of the *lot* which is sodded or gardened or used as a pedestrian walk, play area, swimming pool or uncovered *patio* but shall not include any part of the *lot* used for parking or access *driveways* or for *accessory buildings*;
- (ii) Notwithstanding the provisions of clause (a) of this subsection, not less than 45% of the area of the required or established *front yard*, whichever is less, in any Residential Zone shall be maintained as *landscaped open space* and kept free of *accessory buildings* and *parking lots*.

4.19 Visual Barrier

Where in any *Zone*, a visual barrier is required to be provided and maintained, such barrier shall:

- a) act as a continuous visual screen between *uses*;
- b) be constructed to a minimum *height* of 1.8 metres along the *lot lines*;
- c) be located along the *rear and interior side lot lines* of the *lot* upon which it is required and shall be maintained in healthy condition and good repair by the owner of such *lot*;
- d) shall consist of the following:
 - (i) a noise wall, fence; or
 - (ii) coniferous trees or shrubs; or
 - (iii) earth *berms*; or
 - (iv) any combination of the above

4.20 Lighting

Lighting fixtures designed to provide exterior illumination on any *lot* or *building* shall be installed with the light directed downward and directed or deflected away from adjacent *lots* and *streets* and shall not be in conflict with traffic signals.

4.21 Lot Frontage Regulations

- a) Notwithstanding any other provision in this By-Law, no *building* or *structure* shall be *erected* on a *lot* that does not have frontage on an improved and currently maintained *street* or on a *private street* as described in a registered Plan of *Condominium*.
- b) No *person* shall hereafter *erect* any *building* or *structure* on any *lot* in any *Zone* with a *0.3 metre* reserve along the frontage of the *lot*, except that this provision shall not:
 - (i) Limit frontage on a *street*.

SECTION 4: GENERAL PROVISIONS

- (ii) Subtract from *lot area*.
 - (iii) Apply to a *lot* located on a Plan of Subdivision registered subsequent to the date of the passing of the By-Law.
- c) No *Accessory Dwelling Unit* shall be permitted except where the *main dwelling unit* is directly accessible from a *street*.
- d) *Private streets* that existed on the date of passage of this By-Law shall be considered as *public streets* for the purpose of this By-Law despite the fact that such *private streets* have not been assumed by the County. This provision shall only have the effect for the purpose of applying the *Zone* regulations of this By-Law and not for consideration of granting consents. Furthermore, this provision shall not imply any obligation on the County to assume and/or develop and/or service any *private street* into a *public street*, or to maintain it for *private* or *public* purposes.

4.22 Lots with More than One Zone

4.22.1 Compound Zones

- a) Notwithstanding any other provision of this By-Law, where two or more zoning symbols divided by a “/” are shown on the zoning maps as applying to a *lot* or as compounded by a Special Provision, that *lot* may be *used* exclusively for any *use* permitted in any one of the *Zones*, or for any combination of *uses* permitted in any of the *Zones* included in the compound *Zone* symbol.
- b) In the case of a conflict when selecting a combination of *uses* from compound *Zones*, the more restrictive *Zone* regulations apply.
- c) The parking and loading required by this By-Law for each of the *uses* included in the *development* of the lands, whether for a single *use* or a combination of *uses*, shall be provided.

4.22.2 More than one Zone

Where a *lot* is divided into two or more *Zones*, each such portion of the said *lot* shall be *used* in accordance with the provisions of this By-Law which are applicable to the *Zone* wherein such portion of the said *lot* is located except:

- a) The *lot* shall be treated as one *lot* for the purpose of calculating *lot area* and the *lot coverage* for *existing lots of record* only.
- b) No *lot* shall have more than one residential *dwelling* on the whole *lot* unless otherwise permitted.

SECTION 4: GENERAL PROVISIONS

- c) Where the *main use*, which is conforming to the By-Law and is wholly situated in one *Zone*, an *accessory building or structure* or *use* may be permitted in the other *Zone* provided said *building or structure* complies with the provisions of the said *Zone* and General Provisions Section 4, except that non-residential *accessory structures* shall not be permitted in any Residential *Zones*.
- d) Where any *lot* or the portion of the *lot* is *used* for any non-residential *use*, the more restrictive *Zone* requirements shall apply.
- e) Where a portion of a *lot* is *zoned* Natural Heritage (NH), *yard* dimensions from the permitted *use(s)* shall be measured to the *lot line* rather than any *Zone* boundary that separates the Natural Heritage (NH) *Zone* from other *Zones*. Furthermore, the uses permitted in the other *Zone* shall prevail in this case. Notwithstanding the foregoing, the *lot area*, *lot frontage* and *lot coverage* requirements must be met after the area *zoned* Natural Heritage (NH) is excluded from the calculation.

4.23 Medical Marijuana Production Facility

The following provisions apply to a licensed *Medical Marijuana Production Facility*:

- a) No *building or structure* or portion thereof *used* for *Medical Marijuana Production Facility* situated in Light Industrial *Zone* (M2) and Heavy Industrial *Zone* (M3) shall be located closer to any Residential *Zone or use*, Institutional *Zone or use*, or Open Space *Zone* than 70 metres.
- b) No *building or structure* or portion thereof *used* for *Medical Marijuana Production Facility* situated in the Agricultural *Zone* (A) or Agricultural Employment (AE) *Zone* shall be located closer to any Residential *Zone or use*, Institutional *Zone or use*, or Open Space *Zone* than 150 metres.
- c) The facility operations, including *loading spaces* and storage, must be located within in a wholly enclosed *building*.
- d) *Open storage* is prohibited.
- e) All *development* in relation to the establishment of or expansion to a *Medical Marijuana Production Facility* shall be subject to Site Plan Control process.
- f) A *building or structure used* for security *person* for a *Medical Marijuana Production Facility* may be located in the *front yard*.
- g) Notwithstanding Section 1.9, no minor variance for regulations pertaining to the *Medical Marijuana Production Facility* shall be permitted by Committee of Adjustment and shall only be dealt through a Zoning By-Law Amendment.
- h) A *Medical Marijuana Production Facility* shall only be permitted in the following

SECTION 4: GENERAL PROVISIONS

Zones:

- (i) *Agricultural Zone (A)*
- (ii) *Agricultural Employment Zone (AE)*
- (iii) *Light Industrial Zone (M2)*
- (iv) *Heavy Industrial Zone (M3)*

4.24 Minimum Distance Separation

- a) Notwithstanding any other *yard* or *setback* provisions of this By-Law to the contrary, no *use* shall be established and no *building* or *structure* shall be *erected* or *altered* unless it complies with the *Minimum Distance Separation (MDS) Guidelines* developed by Ontario Ministry of Agricultural, Food and Rural Affairs.
- b) MDS shall apply to *existing lots of record* located in an *Agricultural (A) Zone* or *Agricultural Employment (AE) Zone*.
- c) MDS shall apply to the *uses* permitted in *Agricultural Employment (AE) Zone* in accordance with OMAFRA guidelines. For the purposes of calculating MDS setbacks, such *uses* shall be considered as Type A.
- d) For the purposes of MDS guidelines, inactive cemeteries shall be considered as Type A land *use*.

4.25 Deleted (formerly Mobile Refreshment Carts)

Deleted

4.26 Model Home/Temporary Sales Trailer

Notwithstanding any other provisions of this By-Law, a model home or a temporary sales *trailer* for conducting sales of new units shall be permitted provided the following regulations are met:

- a) The lands on which the model home/ temporary sales *trailer* is to be constructed have received draft plan approval under the Planning Act and the Subdivision or *Condominium* or any other Agreement has been registered.
- b) The model home/ temporary sales *trailer* shall be located within the *development* site and that sales are restricted to the units within that *development* only.
- c) The number of model homes shall be in accordance with the conditions of draft plan approval within the draft plan of subdivision or *condominium* and in no case exceeding 5 *dwelling units* to be *used* as model homes.

SECTION 4: GENERAL PROVISIONS

- d) The *use* shall be permitted in the *Zone* in which the model home is to be located.
- e) The model home shall comply with the provisions and regulations of this By-Law, except for parking, as though the *dwelling*s and/or *dwelling units* were constructed on the *lot*.
- f) The *dwelling units used* for the purpose of model homes shall not be occupied for human habitation prior to the date of registration of the plan of subdivision or *condominium*.
- g) The model home/ temporary sales office shall comply with all applicable terms and conditions of the said subdivision or *condominium* agreement,
- h) The temporary sales *trailer* shall be located 6 metres from any *lot line*.
- i) The *parking area* associated with the Model Home/ temporary sales *trailer* shall be contained on the *development* site and shall be located at least 6 metres from any *lot line*.
- j) The temporary sales *trailer* shall be removed from the site within 1 year of placing on site or within 60 days of completing all sales of *dwelling units*, whichever is less.
- k) No model home or temporary sales *trailer* shall be established until the County has approved the location and the design for the access, *parking area* and grading for these *uses* and have been constructed to the satisfaction of the County.

4.27 Municipal Services

No *buildings* or *structures* may be *erected*, *used* or occupied in any *Zone*, unless the following requirements are met:

- a) watermains, storm and sanitary sewer systems are *existing* and have adequate capacity or have been provided for in a binding and secured Development Agreement and all regulatory approvals have been received to the satisfaction of the County; or
- b) where such services are not required or contemplated, an approved waste disposal system and potable water supply to sustain the *use* of land for *buildings* or *structures* are *existing* or have been provided for to the satisfaction of the Chief Building Official and all regulatory approvals have been received to the satisfaction of the County.

4.28 Non-Conforming Uses

SECTION 4: GENERAL PROVISIONS

4.28.1 Existing Lots of Record

A *lot* in existence prior to the effective date of this By-Law that does not meet the minimum *lot frontage* or minimum *lot area* requirement of the applicable *Zone* is permitted to be *used* and *buildings* and *structures* thereon be *erected, altered, enlarged, repaired, or renovated* provided:

- a) the *use* conforms with the By-Law and the *buildings* and *structures* comply with all other provisions of the By-Law; and
- b) is located within an Agricultural (A) *Zone* and has a minimum 20.0 metre *lot frontage*; or
- c) is located within a Urban Residential *Zone* or Non-Urban Residential *Zone* and has a minimum 8.0 metre *lot frontage*; and
- d) is able to obtain either municipal or *private* services.

The said *lot* shall be deemed to conform to the requirements of this By-Law and all other regulations of the By-Law shall apply.

4.28.2 Legal Non-Conforming Buildings and Structures

A *building* or *structure* that was legally established prior to the passing of this By-Law may be restored, repaired or permitted altered, provided that any addition, *restoration, repairs* or alteration:

- a) do not further encroach into any required *yard*;
- b) do not in any other way increase a situation of non-conformity, and;
- c) comply with all other applicable provisions of this By-Law.

4.28.3 Legal Non-Conforming Uses

Nothing in this By-Law applies to prevent the *use* of any land, *building, or structure* for any purpose prohibited by this By-Law if such land, *building, structure* or *use* was *lawfully used* for such purpose on the day of the passing of the By-Law, provided it continues to be *used* for that purpose.

4.28.4 Acquisition by Public Agency

Notwithstanding any other provision of this By-Law, where a *non-conforming lot, building or structure* is created as a result of the acquisition of part of the *lot* by a *public agency, a building or structure* may be *erected, altered* or repaired and *used* on such *lot*, provided that such *building or structure* comply with all other provisions of this By-Law other than the reduced frontage, reduced *lot area*, reduced *setbacks*, and *lot coverage* requirements. A *building or structure* may be

SECTION 4: GENERAL PROVISIONS

erected, altered or repaired with reduced *lot coverage* as would have been allowed for the *lot* as it existed prior to such public acquisition or conveyance.

4.29 Reduced Lot Frontage for Surplus Farm Dwellings

Where a *lot* is created as the result of a consent granted by the Committee of Adjustment with respect to the disposal of a surplus farm *dwelling* and is located within an Agricultural (A) *Zone* and has a minimum 20.0 metre frontage then the said *lot* shall be deemed to comply to the requirements of this By-Law with respect to the *lot area* or *lot frontage* however, all other regulations of the By-Law shall apply.

4.30 Subsequent Consent and/or Condominium Act

Where the *development* of any land is approved under Section 41 of the Planning Act, and pursuant to a consent subsequently given under Section 53 of the Act, or pursuant to an approval or exemption subsequently given under Section 50 of the Condominium Act, any part of the land is conveyed or otherwise dealt with, the regulations of this By-Law are hereby deemed to apply to the land as a whole and to any *building* or *structure* thereon in the same manner and to the same extent as if the consent, approval or exemption was not given, so long as the land and any *building* or *structure* thereon are *used* and continue to be *used* for the purpose for which the *development* was approved.

4.31 Open Storage

Where specifically listed as a permitted *use* in a *Zone*, *open storage* shall be permitted in accordance with the following provisions:

- a) No *open storage* area shall be located:
 - (i) in the *front yard* or *exterior side yard*; or
 - (ii) in a *yard* which abuts a *Residential use*; or
 - (iii) closer than 6 metres to any *lot line* if combustible materials are stored there.
- b) No *open storage* area shall be considered part of any *landscaped open space* required hereby.
- c) No *parking spaces* or *loading spaces* required by this By-Law shall be *used* for *open storage* purposes.
- d) Any part of any *lot used* for a permitted *open storage* shall be fenced in accordance with the provisions of the Fence By-Law.

4.32 Outdoor Sales or Displays

Where permitted in this By-Law, the outdoor sale or display of goods or

SECTION 4: GENERAL PROVISIONS

commodities is subject to the following:

- a) it must be *accessory* to the permitted *use*;
- b) goods or commodities shall be displayed no closer to the required *side yard* or the required *rear yard*;
- c) the area for the outdoor sale or display of goods or commodities shall not be located in areas required for parking, loading, *driveways* or landscaping.

4.33 Propane Fuel Storage and Handling Facilities

Unless otherwise specified in the *Zone*, the following provisions shall apply for propane fuel storage and handling facilities:

- a) The propane fuel storage and handling facility shall comply with the Technical Standards and Safety Authority (TSSA) requirements.
- b) An above ground propane *fuel storage tank* shall be located in accordance with the *yard* requirements of the *Zone* it is located in.
- c) Notwithstanding Clause a), no part of a propane fuel dispensing island or an above ground propane *fuel storage tank* shall be located closer than 4.5 metres to a *street line* or *lot line*.
- d) *Fuel storage tanks* or equipment *used* in the dispensing, storage, handling or transfer of propane fuel in a *propane transfer facility* shall not be located within 30 metres of a residential *use*.
- e) A visual barrier in accordance with Section 4.19 of the By-Law shall be provided for any propane fuel storage and handling facility.

4.34 Setbacks

4.34.1 Special Setbacks

Notwithstanding any other provisions of this By-Law, where a *building* or *structure* is located adjacent to a *street* listed below, no minimum *setback* shall be required:

Road	Location
Grand River Street North and South	Paris Settlement Area, from Charlotte Street to Dumfries Street
William Street	Paris Settlement Area, from Broadway Street West to the Grand River
Mechanic Street	Paris Settlement Area, from Broadway

SECTION 4: GENERAL PROVISIONS

	Street West to the Grand River
King Street	Burford Settlement Area, from Alexander Street to Park Avenue
Main Street South	St. George Settlement Area, from Beverly Street to Victor Blvd. North

4.34.2 Built-Up Areas

Unless permitted under Section 4.28, Non-Conforming Uses, the minimum *setback* required for a *building* or *structure* on a *lot* that is situated between two adjacent *lots* on which are located *existing buildings* not more than 90 metres apart shall be the average of the *established building lines* on the said adjacent *lots*, provided that no *setback* requirement calculated in accordance with this Clause shall exceed the applicable *setbacks* required by the appropriate *Zone* provisions.

4.34.3 Setbacks from Watercourses and Municipal Drains

No *building* or *structure* shall be constructed closer than 15 metres to a warmwater or 30 metres to a coldwater watercourse or a *Municipal Drain* that is not within the Natural Heritage (NH) *Zone* without prior written approval of the *Conservation Authority* and the County. The *setback* from the watercourse is measured horizontally from the *top of bank* of the watercourse.

4.35 Shipping Containers

The following regulations apply to the storage or *use* of *shipping containers* on any *lot*:

- a) *Shipping container* shall only be permitted within the following *Zones*:
 - (i) Agricultural (A) *Zone*
 - (ii) Agricultural Employment (AE) *Zone*
 - (iii) General Commercial (C2) *Zone*
 - (iv) Automotive Commercial (C6) *Zone*
 - (v) Employment (M) *Zones* and
 - (vi) Resource Extractive (EX) *Zone*
- b) The maximum number of *shipping containers* located on a *lot* shall not exceed one (1).
- c) The location of the *shipping container* shall comply with the requirements of the *accessory structures* in the applicable *Zone*.
- d) Shall only be *used* for storage purposes only and shall be *accessory* to the *main use* on the *lot*.

SECTION 4: GENERAL PROVISIONS

- e) No *person* shall *use* or permit the *use* of any *shipping container* for the *use* of harbouring animals, permanent or temporary living accommodations, habitable *use* or as a *dwelling unit*.
- f) Shall not be permitted within *front yard* or *exterior side yard*.
- g) Shall not be located in a *yard* abutting any Residential *Zone*.
- h) *Shipping container* shall not be *used* to support any roof *structure*.
- i) *Shipping container* shall not be modified in any form to change the appearance or its *structure* for intended *use*.

4.36 Special Policy Area

Certain portions of the Paris Settlement Area are located within the *flooding hazard* of the Grand River and the Nith River and are subject to special regulations. These lands are identified by the symbol “s” preceding the applicable *Zone* symbol and shall be subject to all of the regulations and requirements of the *Zone* following the symbol “s” as well as the following requirements.

4.36.1 Prohibited uses

Notwithstanding any *uses* permitted by the underlying *Zone* the following *uses* shall be prohibited in a Special Policy Area *Zone*:

- a) an institutional *use* including *hospitals*, long-term care homes, *retirement homes*, group home, pre-schools, nurseries, *day cares* and *schools*;
- b) an essential emergency service such as that provided by fire, police and ambulance stations; or
- c) *uses* associated with the disposal, manufacture, treatment or storage of chemical, hazardous or toxic substances.

4.36.2 Additional requirements

- a) Any residential *development* shall be permitted subject to approval by the *Conservation Authority*, and that the habitable floor space is located at the minimum elevation equal to the Regulatory Flood Level and that the *structure* is *flood proofed* to the Regulatory Flood Level.
- b) Additions and *alterations* up to fifty percent (50%) of the *gross floor area* of *existing* residential *buildings* and *structures* shall be permitted subject to approval by the *Conservation Authority*, provided the new habitable floor space is constructed no lower than the existing habitable floor space and *flood proofed* to the existing floor and/or opening elevation where feasible. Furthermore, the *development* of non-residential *buildings* and *structures*

SECTION 4: GENERAL PROVISIONS

shall be permitted where *floodproofing* to the Regulatory Flood Level can be achieved.

4.37 Steep Slopes

On lands located adjacent to a watercourse or *wetland* where the *Conservation Authority* has identified unstable steep slopes (recognized by symbol “ss”), geotechnical studies, prepared by a qualified engineer, may be required in association with *development* proposals along such lands.

4.38 Swimming Pools

4.38.1. Private Outdoor Swimming Pools

The following provisions shall apply with respect to the *erection* or *use* of any private outdoor swimming pool:

- a) Outdoor swimming pools and hot tubs or related *accessory structures* shall not be included in the maximum *lot coverage* requirement for *accessory buildings and structures* in any Residential Zones.
- b) Residential Uses: Where an outdoor swimming pool or hot tub is provided *accessory* to a residential *use*, the following regulations apply:
 - (i) If located in the *rear yard* or *interior side yard*, the swimming pool or hot tub shall be set back 1.2 metres from the applicable *lot line*.
 - (ii) In the case of a *corner lot*, the swimming pool or hot tub shall be set back 3.5 metres from the *exterior side lot line*.
 - (iii) The swimming pool or hot tub shall not be located in a *front yard*.
 - (iv) The maximum *height* of a swimming pool or hot tub shall be 1.5 metres above *grade*.
 - (v) Any *accessory structures* such as saunas, pump houses and change rooms, shall be located minimum 1.2 metres to any *side or rear lot line*. However, all unenclosed water circulating or treatment equipment such as pumps or filters shall be located minimum 3 metres to the *lot line*.
 - (vi) All *setbacks* shall be measured to the water's edge.
- c) All Other Uses: Where an outdoor swimming pool or hot tub is provided *accessory* to any other *use*, the minimum *yard setbacks* for the applicable *Zone* shall apply and shall be measured to the water's edge.
- d) *Decks* associated with an above ground swimming pool that is attached to the *main building* on the *lot* shall be permitted in an any *side yard* and *rear*

SECTION 4: GENERAL PROVISIONS

yard where such *deck* is 1.2 metres or less in *height* and otherwise complies with the provisions of this By-Law regarding *accessory structures*;

- e) All swimming pools shall be fenced *erected* in accordance with the *County's* Fence By-Law.

4.38.2. Private Indoor Swimming Pool

An indoor swimming pool shall comply with the relevant provisions of this By-Law regarding *accessory buildings and structures* including the determination of *lot coverage*.

4.38.3. Public Swimming Pools

Any *public* swimming pool and any related *buildings* or *structures* shall comply with the *Zone* requirements set out herein for the *Zone* in which such swimming pool is located.

4.39 Uses Associated with a Restaurant

Notwithstanding any other provisions of this By-Law, the following shall apply to *outdoor patios, decks* and outdoor recreation *uses* associated with a permitted *restaurant*.

- a) No *outdoor patio* shall accommodate more than fifty percent (50%) of the enclosed capacity of the associated *restaurant* or a maximum of 50 people, whichever is the greater.
- b) No *outdoor patio* shall be permitted unless a minimum set back of 20.0 metres is maintained from any abutting *lot zoned* Residential or Institutional.
- c) Any outdoor lighting shall be directed toward or onto the *outdoor patio* area and away from adjoining properties and *streets*.
- d) The *outdoor patio* shall not be completely enclosed and in the case of a roof-top *restaurant* ratio, it shall be located directly above the permitted *restaurant*.
- e) *Parking spaces* shall be required for the *outdoor patio* at the same ratio as an enclosed *restaurant*.

4.40 Uses Permitted In all Zones

Notwithstanding any provision contained in this By-Law to the contrary, the following *uses* shall be permitted in all *Zones*, including those *Zones* subject to special provisions, unless such *use* is specifically identified as not being permitted:

- a) a *street* or a *public right-of-way*

SECTION 4: GENERAL PROVISIONS

- b) a site for a public memorial or ornamental *structure* including, but not limited to, a statue, a monument, a cenotaph, clock tower, or a fountain;
- c) *A stormwater management facility*;
- d) Services and utilities of *public agency* such as water lines, wastewater lines, gas distribution mains, telecommunications and other cabled services, district energy facilities without cogeneration, pumping stations, and local electric power lines or other communication lines not including *electricity generation facilities*. However, no goods, material or equipment shall be stored or processed in the open, unless such outside storage or outside processing is specifically permitted in the *Zone*;
- e) *A municipal office building, a public community centre, public auditorium, a public library, public park, public washroom and a municipal or provincial works yard*;
- f) Federal or Provincial *use*;
- g) *Wayside pits, wayside quarries, portable asphalt plants and portable concrete plants used on public agency contracts* shall be permitted in all *Zones* except those areas of *existing development* or particular environmental sensitivity which have been determined to be incompatible with extraction and associated activities.
- h) Works of *Conservation Authority*;
- i) *Existing* places of worship;
- j) A Canada Post mailbox;
- k) *Accessory uses*, in accordance with the requirements of General Provisions Section 4 of the By-Law;
- l) A temporary construction camp, tool shed, scaffold or other such *building* or other such temporary work camp which is incidental to construction and provided it is:
 - (i) located on the site where such work is underway, and
 - (ii) until the work is completed or abandoned, and
 - (iii) not *used* for human habitation, and
 - (iv) until a valid building permit for the said construction remains in force, and
 - (v) removed from the site within 60 days of completing the work.
- m) *Food service vehicles*, in accordance with Section 4.44 of this By-law.

SECTION 4: GENERAL PROVISIONS

4.41 Uses Prohibited in all Zones

The following *uses* are prohibited, either alone or in conjunction with other *uses*, unless specifically listed as a permitted *use* in a specific *Zone*:

- (a) the tanning or storage of raw hides, skins, leather and/or hair;
- (b) the boiling of blood, tripe, bones or soaps; fat, grease, lard or tallow rendering or refining operation; the extracting of oil from fish or animal matter;
- (c) the manufacturing of glue or fertilizers from dead animals or from human or animal waste;
- (d) an *abattoir*, *livestock yard*, *livestock* exchange, or dead stock depot;
- (e) the keeping or raising of any *livestock* or *poultry* or *aviary* or birds. This provision shall not prevent the keeping of *household pets* in compliance with the County's Animal Control By-Law;
- (f) the keeping of any species that is prohibited in County's Animal Control By-Law;
- (g) a *kennel* or a *boarding facility kennel*;
- (h) a track or facility for the driving, racing or testing of motorcycles, snowmobiles or any other motorized *vehicles*;
- (i) a *salvage yard*;
- (j) a *waste disposal site*;
- (k) facilities generating, treating or disposing hazardous wastes;
- (l) any facility generating *energy from waste* products;
- (m) the refining, storage or *use* in manufacturing of coal oil, rock oil, fuel oil, natural gas, propane, burning fluids, naphtha, bensole, benzene, gasoline, dynamite, dualin, nitroglycerine, gun powder, petroleum or any other combustible, inflammable, volatile or otherwise dangerous liquids, gasses or solid materials except where specifically permitted or in conjunction with a permitted *use* in any Employment *Zone*. This provision shall not apply to prevent the above ground storage of such substances by a farmer, where such storage is incidental and *accessory* to an *agricultural use*, or the *use* of natural gas, propane or fuel oil for domestic purposes, in conjunction with a residential *use* or for commercial or industrial *uses*;

SECTION 4: GENERAL PROVISIONS

- (n) any *use* which causes the emission of corrosive gasses, toxic gasses or radioactive gasses electromagnetic fields, heat, glare, dust, dirt, fly ash or smoke, in any *Zone* other than *Employment Zones* or which does not comply with emission regulations as established by any Public agency;
- (o) an explosive, ammunition or fireworks manufacturing and/or storage facility;
- (p) an airport;
- (q) the repair or servicing of any *vehicle* unless such *vehicle* is owned by and registered in the name of an owner or occupant of such *lot* or *building*;
- (r) any establishment *used* as an *adult entertainment parlour*;
- (s) furniture or wood stripping or refinishing and/or wood preserving and treating;
- (t) outdoor storage of road salt, or other de-icing materials and dumping of salt-laden snow;
- (u) chemical/biological laboratory;
- (v) electroplaters and metal fabricators;
- (w) *batching plants*;
- (x) a *campground*, except as a temporary *use* within a *public park*, with the approval of the *County*;
- (y) The *use* of temporary *structures*, tents, *trailers* or *recreational vehicles* for living, business, storage of merchandise or other purposes, is prohibited except:
 - (i) In a *mobile home* where specifically permitted.
 - (ii) Tents may be *used* for children's play, excluding camps.
 - (iii) When *used* by the operators of a circus, carnival, fair, festival or carousel for a maximum period of 7 days.
 - (iv) Tents or *trailers* may be *used* for a special occasion or special sale of goods or merchandise in conjunction with a permitted *use*, for a maximum of three occasions in a 12 month period, subject to a maximum of 10 days duration per occasion.
 - (v) Where a *dwelling unit* or place of business is destroyed by accident or natural disaster, a temporary *structure*, tent, *trailer* or *recreational vehicle* may be *used* as a temporary *dwelling* or place of business on that *lot* by the residents or occupants of the premises, for a maximum period of 12 months.

SECTION 4: GENERAL PROVISIONS

4.42 Wellhead Protection Areas

Schedule “D” identifies Wellhead Protection Areas (WHPA) and groundwater recharge areas that shall be protected to ensure the protection of municipal water. Within an identified WHPA and groundwater recharge area, the following uses shall not be permitted:

- a) underground transmission of oil, gasoline, or other petroleum liquid products;
- b) commercial wood preserving and treating;
- c) furniture and wood stripping and refinishing;
- d) outdoor storage of road salt, or other de-icing materials and dumping of salt-laden snow;
- e) petroleum product refining and manufacturing;
- f) landfills;
- g) chemical/biological laboratory;
- h) chemical manufacturing/industrial areas;
- i) disposal of leachable waste;
- j) electroplaters and metal fabricators;
- k) facilities generating, treating or disposing hazardous wastes;
- l) automobile wrecking yards;
- m) bulk fuel oil storage yards;
- n) car washes;
- o) cemeteries;
- p) dry cleaning facilities;
- q) gasoline service stations;
- r) underground storage tanks.

4.43 Yard Encroachments

Any structural encroachments into the required *yards* on a *lot* shall be subject to the following requirements, however, no *yard* encroachments shall be permitted in any *visibility triangles*.

Table 4.6 Yard Encroachments in required yards

Structure	Yard in which structure is permitted	Permitted encroachment in the required yard
Architectural adornments including, but not necessarily restricted to, sills, belt courses, chimneys, bay windows,	All <i>yards</i>	0.5 metres

SECTION 4: GENERAL PROVISIONS

Structure	Yard in which structure is permitted	Permitted encroachment in the required yard
cornices, coves, eaves, gutters, awnings, canopies, cantilevered wall, parapets and pilasters		
<i>Canopy (attached to an apartment dwelling)</i>	<i>Front yard and side yards</i>	6.0 metres, provided the projection is no closer than 3.0 metres to a <i>lot line</i>
Gate House within any Employment Zone	<i>Front yard or side yard</i>	No required <i>setback</i>
Heat pumps, air conditioners, and/or air exchangers	All yards	1.5 metres, provided the projection is no closer than 0.6 metres to the <i>lot line</i>
<i>Patios uncovered</i>	<i>Front yard, rear yard and exterior side yards</i>	No closer than 0.6 metres from the <i>lot line</i> .
Railway spur, Accessibility Ramps	All yards	No required <i>setback</i>
Roofless functional and ornamental structures including, but not necessarily restricted to, drop awnings, clotheslines, poles, ornamental fountains, statues, monuments, picnic tables, benches, planters, garden trellises, and retaining walls.	All yards	No required <i>setback</i>
<i>Satellite Dishes (not attached to the main building)</i>	<i>Front yard or Exterior Side Yard</i>	No closer than 0.3 metres from any <i>lot line</i> .
Stoops, unenclosed <i>porches</i> , balconies, landings, exterior stairs	All yards	1.5 metres
Unenclosed fire escapes	<i>rear yard and side yard</i>	1.5 metres, provided the projection is no closer than 0.6 metres to the <i>lot line</i> , except in case of a <i>Accessory Dwelling Unit</i>

SECTION 4: GENERAL PROVISIONS

4.44 Regulations for Food Service Vehicles

Food Service Vehicles shall only be permitted in accordance with the City of Brantford Licensing By-law, as amended from time to time.

4.45 Regulations for Short Term Rental Accommodations

Notwithstanding any other provision of this By-law, any short term rental accommodation shall be permitted within all zones where residential uses are permitted, subject to the following provisions:

- .1 A short term rental accommodation must be operated by the person or persons whose principal residence is the dwelling in which the short term rental accommodation is located. For the purposes of this Section, entire accessory dwelling unit shall be included as part of a principal residence.
- .2 Short term rental accommodations shall not take place on the same lot as a bed and breakfast establishment.
- .3 For short term rental accommodations with up to three (3) bedrooms per unit, the principal residential use parking requirements shall apply. For four (4) or more bedrooms per unit, one additional parking space per bedroom will be required. Required additional parking for the short term rental accommodation use may include tandem parking spaces or parking spaces located within a minimum front yard where the required parking space cannot be provided behind the front wall of the main building for short term accommodations located within a single detached, semi-detached, converted dwelling, duplex, townhouse or accessory dwelling unit.
- .4 Short term rental accommodations shall be regulated by the applicable zoning provisions pertaining to the principal use and by the regulations of Section 4.5 – Accessory Dwelling Units, where necessary.
- .5 Short term rental accommodations must be registered through the Short Term Rental Accommodation registry program, as amended.

SECTION 5: PARKING AND LOADING REQUIREMENTS

5.1 General Requirements

- a) No *lot, building, structure* or *use* shall be *erected* or *used* in any *Zone*, unless *off-street* parking is provided and maintained on such *lot*, in accordance with the provisions of this section.
- b) Any *lot, building* or *structure* *used* or *erected* for any purpose involving the receiving, shipping loading or unloading of animals, goods, wares, merchandise or raw materials, shall provide and maintain, on the same *lot, loading spaces* in accordance with the provisions of this section.
- c) Where a *building, structure* or *lot* accommodates more than one type of *use*, the total *parking space* or *loading space* requirement shall be the sum of the requirements for each of the component *uses*.
- d) No *use*, including but not limited to, storage or parking of *vehicles* for hire, gain, display or sale shall be located on any required *parking space* or *loading space* or obstruct any required parking or *loading space*.
- e) Where visitor *parking spaces* are required, a *parking space* on a *driveway* shall not be *used* for calculating the required visitor parking.
- f) Nothing in this By-Law shall prevent the *erection* of a shelter for *use* solely by parking attendants or security personnel in any part of a *parking area*, except within a *visibility triangle*, provided such shelter is not more than 4.5 metres in *height* and has a *floor area* of not more than 5 square metres.

5.2 Rounding Provision

Notwithstanding the provisions in Section 2.13 of this By-Law, where the application of any ratio in this section results in a fraction of a *parking space* or *loading space* being required, the minimum number of spaces required shall be increased to the next highest whole number.

5.3 Non-Conforming Uses

Additional *parking spaces* or *loading spaces* shall be provided in accordance with the provisions of this By-Law for all *uses* on a *lot* in the following circumstances:

- a) Where any addition to an *existing building* or *structure* or additional *gross floor area* is added to a *legal non-conforming building* or *structure*.
- b) Where a change in *use* occurs that has the effect of requiring the additional *parking spaces* or *loading spaces*.

SECTION 5: PARKING AND LOADING REQUIREMENTS

5.4 Exceptions to Downtown Commercial Core

Notwithstanding the requirements of Sections 5.11 and 5.12, no *parking spaces* or *loading spaces* shall be required for any *building* or *structure* or *use* located within a Core Area Commercial (C4) *Zone* on Grand River Street North between the Nith River and Charlotte Street in Paris, or on Main Street South between Beverly Street and Hawk Street in St. George, or on King Street between Alexander Street and Park Avenue in Burford, or on Simcoe Street or Elgin Street in Scotland, or on Oakland Street in Oakland.

5.5 Enclosed Parking Areas/ Parking Structures

- a) Every above-ground *structure* containing a *parking area* shall comply with the provisions for the *Zone* where such *structure* is located. Where such *structure* containing a *parking area* is *accessory* to a permitted *use* on a *lot*, then such *structure* shall conform to all the provisions for *accessory* uses set out in General Provision Section 4 of this By-Law.
- b) Nothing in this By-Law shall prevent the location of an underground *parking area* in any part of a required *side yard setback* or *rear yard setback* on a *lot* provided such underground *parking area* is not within 3 metres of a *lot line*.
- c) Parking shall not be permitted on the *front yard* or *exterior side yard* of a *building* or *structure* in a Mixed Use *Zone* or Core Area *Zone*.

5.6 Requirements for Accessible Parking

- a) In addition to the *parking spaces* required under Section 5.11 and 5.12, the parking for all *uses* that require visitor *parking spaces* shall provide accessible parking in accordance with the regulations stated in this sub-section.
- b) Accessible *parking spaces* shall be provided and maintained on the same *lot* in proximity to the main entrances to the *use*, *building* or *structure*. (See Appendix A for illustration).
- c) Accessible *parking spaces* shall include two types of accessible *parking spaces* and shall have the following requirements:
 - (i) Type A space – Minimum width of 3.4 metres
 - (ii) Type B space – Minimum width of 2.8 metres
 - (iii) The minimum length for an accessible *parking space* shall be 5.5 metres.
- d) *Aisles* shall be provided in accordance with the following requirements:
 - (i) Minimum width of 1.5 metre (yellow striped buffer area) which shall include a depressed curb.

SECTION 5: PARKING AND LOADING REQUIREMENTS

- (ii) In case of *parking spaces* with double *aisle*, the *aisle* area shall be increased to 1.6 metres.
- (iii) The *aisle* must extend full length of the parking space.

Table 5.1 Accessible Parking Requirements

Number of Parking Spaces Required	Minimum Number of Accessible Parking Spaces Required	Type A Parking Spaces	Type B Parking Spaces
1-12	1	1	0
13-100	4%	a) <u>For lots that require an even number of total accessible <i>parking spaces</i> – provide an equal number of Type A and Type B spaces.</u> b) <u>For lots that require an odd number of total accessible <i>parking spaces</i> – provide an equal number of Type A and Type B spaces. The additional <i>parking space</i> may be Type B space.</u>	
101-200	3% + 1		
201-1000	2% + 2		
1001+	1% + 11		

5.7 Specifications for parking/loading and Access regulations

- a) A *parking space* required hereby shall have minimum rectangular dimensions of 2.8 metres by 5.5 metres, except where parallel parking is provided, the minimum dimensions of the required *parking space* shall be 2.5 metres by 6.7 metres.
- b) Each *loading space* shall have minimum dimensions of 3.5 metres by 10 metres with a vertical clearance of 4 metres.
- c) Where a wall, column, or other obstruction is located abutting any *parking space*, the minimum width of the *parking space* shall be increased by 0.3 metres for each side that is obstructed. Obstructions within 1.15 metres of either stall end do not require an increase in *parking space* width, provided the obstruction projects no more than 0.15 metres into the *parking space*.
- d) The *parking space* in any Residential Zones inside a *garage* or a *carport* shall have a minimum dimensions as stated below:
 - (i) 3 metres wide by 6.0 metres length, where one *parking space* is provided; and
 - (ii) 2.8 metres wide by 6.0 metres length for the first *parking space* and 2.8 metres wide by 5.5 metres length for the second parking space where two *parking spaces* are provided.

SECTION 5: PARKING AND LOADING REQUIREMENTS

- e) Access to *parking spaces* and *loading spaces* shall be provided from an improved *street* by means of one or more unobstructed *driveways* unless shared *easement* is registered on lands.
- f) In any Residential *Zone*, the minimum width of the *driveway* shall be 2.8 metres with a maximum width of 7 metres. A *driveway*, that is *altered* to accommodate parking for a *Accessory Dwelling Unit*, shall not be wider, at any point, than 45% of the *lot* width measured at the *street line* to a maximum width of 8.8 metres.
- g) On a *lot* with a width of 11.0 metres or less, a *driveway* may extend beyond the width of the attached *garage* to a maximum width of 55% of the *lot* width or 5.5 metres, whichever is less; and shall be located no closer than 0.6 metres to a *side lot line*;
- h) On a *lot* with a width greater than 11.0 metres, the *driveway* may extend beyond the width of the attached *garage* to a maximum width of 50% of the *lot* width or 8 metres, whichever is less; and shall be located no closer than 0.6 metres to the *side lot line*;
- i) In the case of a *semi-detached dwelling* with an attached *garage* the *driveway* may extend beyond the width of the attached *garage* to a maximum width of 5.5 metres and shall be located no closer than 0.6 metres to the *side lot line* which is not located along the common wall of the same *dwelling*;
- j) In the case of a *dwelling* without an attached *garage*, the *driveway* width shall not exceed 5.5 metres within the *front yard*, *side yard*, or *exterior side yard*;
- k) In all *Zones* other than Residential *Zones*, the width of the *driveway* shall not exceed 10 metres.
- l) The combined width of a *mutual driveway* shall not exceed 10 metres.
- m) *Driveways* and parking *aisles* shall have a minimum unobstructed width of 6 metres where two-way traffic is permitted and 3 metres where only one-way traffic is permitted and is clearly indicated by *signs*, pavement markings or both.
- n) Where a two-way *driveway* is divided into two one-way *driveways* by a curb, an area of *landscaped open space* or any other obstruction, such *driveway* shall be considered a single access *driveway*, provided that such *driveway* does not exceed 10 metres in total width.
- o) Nothing in this subsection shall apply to prevent the *use* of a *right-of-way* as a means of obtaining access to a *parking space*, provided the said *right-of-way* has been specifically established for such purpose.

SECTION 5: PARKING AND LOADING REQUIREMENTS

5.8 Location of Required Parking and Loading Spaces

- a) With the exception of the Core Area (C4) Zone, all required *parking spaces* or *loading spaces* shall be provided on the same *lot* occupied by the *building, structure* or *use* for which such *parking spaces* or *loading spaces* are required, and shall not form a part of any *street* or *lane*.
- b) Notwithstanding Clause (a) above, where the provision of off-street parking on the same *lot* as the *use* requiring such off-street parking is not possible, such off-street parking facilities may be located on another *lot* within 400 metres of the *lot* containing the *use* requiring the parking. Such alternate parking shall only be situated in a Core Area (C4) Zone, Mixed Use (C5) Zone or any Employment Zone provided a *Site Plan Agreement* is registered on title of the *lot* used for parking committing said *parking spaces* to the related *use*.
- c) *Parking spaces* for a *Accessory Dwelling Unit* must be provided on the same *lot* as the *main dwelling* and cannot be in tandem with the required parking for the *main dwelling*.
- d) Notwithstanding the *yard* and *setback* provisions of this By-Law to the contrary, uncovered surface *parking areas* shall be permitted in the required *yard setbacks* as follows:

Table 5.2 Parking Yard Requirements

Zone	Yard in which required parking space is permitted
Commercial, Institutional, Employment, Open Space, Resource Extraction	<ol style="list-style-type: none"> a) All <i>yards</i> provided that no part of any <i>parking area</i>, other than a <i>driveway</i>, is located closer than 3 metres to any <i>street line</i>, b) Notwithstanding clause (a) above, no commercial/industrial equipment or commercial/industrial <i>vehicle</i> or a <i>trailer</i> shall be permitted to be parked within the required <i>yard setback</i> abutting a residential use. c) In the Mixed Use (C5) Zone, parking shall not be permitted in the <i>front yard</i>.
Residential	<ol style="list-style-type: none"> a) In <i>front yard</i> and <i>exterior side yard</i> provided that no part of any <i>parking space</i> is located closer than 3 metres to the <i>lot line</i>; b) In <i>yards</i> leading directly to a <i>garage</i>, a <i>carport</i> or a <i>parking space</i>; c) No <i>person</i> shall park or permit to park a <i>vehicle</i> in the <i>front yard landscaped open space</i> of any <i>lot</i>.

SECTION 5: PARKING AND LOADING REQUIREMENTS

- e) Location of required *loading spaces*:
- (i) The *loading space* shall be provided in front of the loading and unloading areas, bays or doors or docks etc.
 - (ii) The *loading space* shall not be permitted in required *front yard setback* and required *exterior side yard setback*.
 - (iii) No part of any *loading space* shall be closer than 3 metres to any *lot line*.

5.9 Surface Treatment and Drainage

- a) All *parking areas*, *driveways* and *loading spaces* shall be constructed and maintained with a stable surface, treated so as to prevent the raising of dust or loose particles, using such surfacing materials as gravel, asphalt, concrete, interlocking brick, or other hard-surfaced material sufficient to provide stability, prevent erosion, be usable in all seasons, and allow infiltration of surface water.
- b) The surface of every *parking area*, *driveway* or *loading space* located in any *yard* in any Commercial and Employment Zone or a commercial/industrial use, which is located adjacent to any Residential Zone, shall be paved with asphalt, concrete or paving stones.

5.10 Loading Space Regulations

The number of *loading spaces* required on a *lot* shall be based on the total *gross floor area* of all the *uses* on the said *lot* for which *loading spaces* are required in accordance with the following:

Table 5.3 Loading Space Regulations

Size of Building	Minimum number of Loading Spaces required
Up to 250 m ²	0
251 m ² to 500 m ²	1
501 m ² to 2,500 m ²	2
2,501 m ² to 7,500 m ²	3
7,500 m ² and over	3, plus one space for each additional 10,000m ²

SECTION 5: PARKING AND LOADING REQUIREMENTS

5.11 Parking Space Requirements for Residential Uses

Table 5.4 Parking Requirements for Residential Zones

Type of use	Minimum required off-street parking space Regulations
<i>Accessory Dwelling</i>	2 spaces per unit
<i>Apartment Dwelling</i>	1.00 space per bachelor unit 1.25 spaces per one-bedroom unit 1.40 spaces per two-bedroom unit 1.75 spaces per three-bedroom unit
<i>Converted Dwelling, Duplex Dwelling, Fourplex Dwelling, Rowhouse Dwelling, Semi-Detached Dwelling, Single Detached Dwelling, Stacked Townhouse, Triplex Dwelling</i>	2 spaces per unit
<i>Farm Labour Housing</i>	1 space per unit
<i>Retirement Home</i>	0.75 spaces per unit
<i>Group Home</i>	1 space for the first 3 residents; plus 1 space for each additional two residents; plus 1 visitor space for the first 4 residents;
<i>Lodging House/, Boarding House/Rooming House</i>	1 space per 3 lodging/boarding units
<i>Mobile Home, Modular Dwelling</i>	1 space per unit
<i>Accessory Dwelling Unit</i>	1 space
All other housing forms not identified above with more than two (2) dwelling units	2.0 resident spaces per unit and 0.25 visitor spaces per unit

- a) In addition to above, the *parking spaces* for all non-residential *uses* in the same *building* shall be provided in accordance with Section 5.12 of the By-Law.
- b) In addition to above, visitor parking for *multiple dwellings* including *accessory dwellings*, shall be required as follows:

SECTION 5: PARKING AND LOADING REQUIREMENTS

- (i) 20 percent of the required *parking spaces* for *buildings* containing 5 to 15 *dwelling units*;
 - (ii) 35 percent of the required *parking spaces* for *buildings* containing more than 15 *dwelling units*;
- c) All required visitor parking shall be clearly identified, demarcated and reserved for visitors only.

5.12 Parking Space Requirements for Non-Residential Uses

Table 5.5 Parking Requirements for non-residential Zones

Type of use	Minimum required off-street parking Regulations (per <i>gross floor area</i>)
<i>Agricultural Equipment Sales and Service Establishment</i>	1 per 30 m ²
<i>Agricultural Processing Facility</i>	1 per 30 m ² for retail showroom, plus 1 per 200 m ² for <i>warehouse/wholesale</i>
<i>Agricultural Service and Supply Establishment</i>	1 per 30 m ² for retail showroom, plus 1 per 200 m ² for <i>warehouse/wholesale</i>
<i>Amusement Game Establishment</i>	1 per 25 m ²
<i>Amusement Park</i>	4 per alley, game table or other game surface plus 10 per 100m ² of <i>gross floor area used</i> for dining and assembly
<i>Art Gallery</i>	1 per 50 m ²
<i>Assembly Hall</i>	1 per 8 seats or per 35 m ² whichever is greater
<i>Auction Establishment</i>	1 per 30 m ²
<i>Auto Body Shop</i>	1 per 30 m ²
<i>Automobile Repair Garage</i>	1 per 25 m ²
<i>Automobile Sales or Rental Establishment</i>	1 per 25 m ²
<i>Automobile Service Station</i>	6 per bay
<i>Automotive Use</i>	1 per 25 m ²
<i>Bakery</i>	1 per 100 m ²
<i>Banquet Hall</i>	1 per 8 seats or per 35 m ² whichever is greater
<i>Bed and Breakfast Establishment</i>	1 per guest room in addition to those required for the <i>dwelling unit</i>
<i>Body Rub Parlour</i>	1 per 100 m ²
<i>Building Supply Outlet</i>	1 per 30 m ² for retail/showroom plus 1 per 200 m ² for <i>warehouse/wholesale</i>
<i>Bulk Sales Establishment</i>	1 per 30 m ²

SECTION 5: PARKING AND LOADING REQUIREMENTS

Type of use	Minimum required off-street parking Regulations (per gross floor area)
Car Wash	3 spaces per wash bay
Catering Establishment	1 per 200 m ²
Chemical and Pharmaceutical Industry	1 per 100 m ²
Commercial Greenhouse	1 per 100 m ²
Community Centre	1 per 8 seats or 1 per 25 m ² whichever is greater
Contractor's Yard	1 per 40 m ²
Convenience Store	1 per 25 m ²
Crafts Shop	1 per 100 m ²
Day Care	1 per 40 m ²
Drive-Through Facility	1 per 15 m ²
Dry Cleaning and Laundromat	1 per 25 m ²
Dry Cleaning Establishment	1 per 50 m ²
Electrical and Electronic Products Industry	1 per 100 m ²
Farm Production Outlet	1 per 30 m ²
Feed Mill	1 per 100 m ²
Fertilizer Blending Station	1 per 100 m ²
Financial Institution	1 per 25 m ²
Food Processing Plant	1 per 100 m ²
Florist Shop	1 per 200 m ²
Funeral Home	Greater of 1 per 20 m ² or 20 spaces
Golf Course	6 spaces per hole plus 1.0 per 22.0 m ² gross floor area for any accessory use
Grocery Store	1 per 25 m ²
Group Home	1 per 100 m ² or a minimum of 3 spaces
Home Improvement Centre	1 per 30 m ²
Home Occupation	1 per 50 m ²
Hospital	1 per 30 m ²
Hotel	1.25 per unit
Kennel	1 per 25 m ²
Library	1 per 40 m ²
Manufacturing Facility	1 per 100 m ²
Mineral Aggregate Operation	2 spaces
Museum	1 per 50 m ²
Nursery and Garden Centre	1 per 30 m ² used for retail sales and display of products and/or office; and 1 space per 100 m ² used for warehouse and/or wholesale
Nursing Home	1 per 3 beds
Office-Business or Professional	1 per 30 m ²

SECTION 5: PARKING AND LOADING REQUIREMENTS

Type of use	Minimum required off-street parking Regulations (per <i>gross floor area</i>)
Office, Medical	1 per 15 m ²
Office, Support	1 per 15 m ²
Office Supply Outlet	1 per 30 m ²
Open Storage	1 per hectare (2.5 acres)
Outdoor Retail Display Area	1 per 30 m ²
Paper Products Industry	1 per 100 m ²
Personal Service Establishment	1 per 50 m ²
Pharmacy	1 per 25 m ²
Place of Worship	1 per 5 seats
Printing Establishment	1 per 200 m ²
Private Club	1 per 20 m ²
Processed Goods Industry	1 per 100 m ²
Recreational Establishment	1 per 20 m ²
Research and Development Establishment	1 per 100 m ²
Restaurant	1 per 10 m ²
Retail Store	Less than 1000 m ² : 1 per 25 m ² More than 1000 m ² : 1 per 20 m ²
School, Commercial	1 per 30 m ²
School, Elementary	1.5 per classroom (includes teaching rooms, gymnasium, <i>library</i> etc.) plus 1 per portable classroom
School, Post-Secondary	1 per 100 m ² plus 1 per 15 students
School, Secondary	3 per classroom (includes teaching rooms, gymnasium, <i>library</i> etc.) plus 1 per portable classroom
Service and Rental Establishment	1 per 25 m ²
Service Shop	1 per 25 m ²
Shopping Centre	Less than 2000 m ² : 1 per 35 m ² Greater than 2000 m ² : 1 per 25 m ²
Studio	1 per 45 m ²
Supermarket	1 per 25 m ²
Taxi Stand	1 per 6 m ²
Transport/Truck Terminal	1 per 100 m ²
University	1 per 100 m ² plus 1 space for 6 resident students and/or staff
Veterinary Clinic	1 per 25 m ²
Warehouse	1 per 100 m ²
Warehouse, Public Self Storage	1 per 200 m ²
Wholesale Establishment	1 per 150 m ²

SECTION 5: PARKING AND LOADING REQUIREMENTS

5.13 Commercial Vehicle Regulations

- a) A maximum of one (1) *commercial vehicle* shall be permitted to be parked or stored in any Urban Residential *Zone* or Non-Urban Residential *Zone* entirely within an enclosed *garage* provided that the required number of *parking spaces* for the *main use* is maintained.
- b) No *commercial vehicle*, motorized construction equipment, tow truck, dump truck, tractor *trailer*, semi-*trailer*, bus or similar *vehicles/equipments* shall be parked or stored on any part of a *lot* in any Urban Residential *Zone* or Non-Urban Residential *Zone*, except within a fully enclosed *building* or *structure*.
- c) No *commercial vehicle*, in any Urban Residential *Zone* or Non-Urban Residential *Zone*, shall be permitted to idle or operate in a way that causes any nuisance including but not limited to noise, dust, or emissions on any part of a *lot*.
- d) Notwithstanding clause (b) of this section, a maximum of one (1) *commercial vehicle* shall be permitted in any Urban Residential *Zone* or Non-Urban Residential *Zone* subject to following:
 - (i) The *commercial vehicle* shall not be more than or equal to 3 000 kg registered gross weight and be less than 6.0 metres in length and 2.6 metres in *height*;
 - (ii) No *commercial vehicle* shall be permitted to be parked or stored in a *front yard setback*, an *exterior side yard setback*, or closer than 3 metres to any other *lot line*.
 - (iii) Notwithstanding clauses (i) and (ii) above, school buses shall be permitted to be located in the *interior side yard and rear yard*. Parking of the school bus shall be provided in addition to the required parking on the property.
- e) Nothing in this By-Law shall prevent the parking of a *commercial vehicle* or motorized construction equipment in any Urban Residential *Zone* or Non-Urban Residential *Zone* for a temporary basis for the immediate purpose of making deliveries or otherwise providing services to that *lot*.
- f) Notwithstanding the clauses above, agricultural implements or commercial and industrial equipment, or any component thereof, shall not be parked or stored on a *lot* within any Urban Residential *Zone* or Non-Urban Residential *Zone*.
- g) Notwithstanding the clauses above, agricultural implements or commercial and industrial equipment, or any component thereof, shall not be parked or stored in the required *yard* of any other *Zone* abutting Urban Residential *Zone*, Non-Urban Residential *Zone* and Institutional *Zone*.

SECTION 5: PARKING AND LOADING REQUIREMENTS

5.14 Recreational Vehicle Regulations

- a) The *parking space used for recreational vehicles* shall be in addition to the required number of *parking spaces* for the applicable *Zone*.
- b) Where the *lot area* is greater than 4,000 square metres, the following regulations for parking of a *recreational vehicle* on a *lot* with a residential use shall apply:
 - (i) The *recreational vehicle(s)* may be located entirely within an enclosed *garage*.
 - (ii) Only one *recreational vehicle* shall be permitted to be parked unenclosed on any *lot*:
 1. Shall not be parked or stored in any required *yard setback* for the applicable *Zone*, and
 2. Must be screened by a visual barrier according to Section 4.19.
- c) Where the *lot area* is less than 4000 square meters, the following regulations for parking of a *recreational vehicle* on a *lot* with a residential use shall apply:
 - (i) The *recreational vehicle(s)* may be located entirely within an enclosed *garage*.
 - (ii) Only one *recreational vehicle* shall be permitted to be parked unenclosed on any property on the *driveway* during the period from May 1st to October 31st in each year, inclusive, provided that such equipment:
 1. shall not obstruct the visibility of movement of vehicular or pedestrian traffic within a *street* or *lane*;
 2. shall be located a minimum of 1.5 metres from the *street lot line*;
 3. shall not exceed a maximum *height* of 2.5 metres.
 - (iii) The *recreational vehicle(s)* may not be parked or stored in a *carport* unless screened by a visual barrier;
 - (iv) The *recreational vehicle(s)* shall not be parked or stored in any required *yard setback*.
- d) Snowmobiles maybe stored or parked on a *driveway* of a *lot* with a residential use between December 1st and March 31st provided that:
 - (i) The *parking space used for snowmobile* shall be in addition to the required number of *parking spaces* for the applicable *Zone*.
 - (ii) such equipment is fully contained on the *lot*,

SECTION 5: PARKING AND LOADING REQUIREMENTS

- (iii) shall not obstruct the visibility of vehicular or pedestrian traffic movement within a *street* or *lane*;
- (iv) shall be located a minimum of 1.5 meters from the *lot line*.
- e) No *recreational vehicle* or snowmobile or other similar recreational equipment shall be *used* as a *dwelling unit* or for residential purposes.
- f) No *recreational vehicle* or snowmobile or other similar recreational equipment shall be parked or located on the *road allowance*.

SECTION 6: AGRICULTURAL (A) ZONE

6.1 Uses Permitted

No person shall within any Agricultural (A) Zone, use any lot or erect, alter or use any building or structure for any purpose except for one or more of the following uses as identified by a “dot”:

Table 6.1: Uses Permitted

List of Uses	Permitted
<i>Agricultural Use</i>	•
<i>Aviary</i>	•
<i>Dwelling, Single Detached</i>	•
<i>Farm Labour Housing</i>	•
<i>Farm Production Outlet</i>	•
<i>Forestry Uses</i> excluding any establishments that either process forestry products or sell processed forestry products such as <i>lumber mills</i> ;	•
<i>Farm Greenhouse</i>	•
<i>Livestock Facility</i>	•
<i>Medical Marijuana Production Facility</i>	•
<i>Shipping Container</i> in accordance with Section 4.35	•

6.2 Zone Requirements

No person shall, within any Agricultural (A) Zone, use any lot or erect, alter or use any building or structure except in accordance with the following provisions:

Table 6.2: Zone Requirements

Provision	All Other Uses	Dwelling
Lot Area , Minimum (ha)	40.0	40.0
Lot Frontage , Minimum (metres)	150.0	150.0
Street Setback , Minimum (metres)	25.0	10.0
Interior Side Yard Setback , Minimum (metres)	15.0	4.0

SECTION 6: AGRICULTURAL (A) ZONE

Provision	All Other Uses	Dwelling
Rear Yard Setback , Minimum (metres)	15.0	10.0
Lot Coverage , Maximum	30%	30%
Landscaped Open Space , Minimum	30%	30%
Building Height , Maximum (metres)	10	10

6.3 Special Exceptions A Zone

By-Law No.	Zone Code	Description
121-02, 52-03, 151-06, 49-04, 15-07, 1-87, 124-11	A-1	Notwithstanding any provisions of this By-Law to the contrary, within any area <i>zoned</i> A-1 on Schedule “A” hereto, in addition to the <i>uses</i> permitted in the Agricultural (A) Zone, a maximum of two <i>single detached dwelling units</i> shall also be permitted. All other requirements of the By-Law shall apply.
121-02	A-2	Notwithstanding any provisions of this By-Law to the contrary, within any area <i>zoned</i> A-2 on Schedule “A” hereto, in addition to the <i>uses</i> permitted in the Agricultural (A) Zone, the selling of antiques and the refurbishing of furniture shall also be permitted. This activity shall be confined to <i>buildings</i> and <i>structures</i> as they existed on August 2001. All other requirements of the By-Law shall apply.
121-02, 93-23P	A-3	Notwithstanding any provisions of this By-Law to the contrary, within any area <i>zoned</i> A-3 on Schedule “A” hereto, in addition to the <i>uses</i> permitted in the Agricultural (A) Zone, a <i>contractor’s yard</i> shall also be permitted. All other requirements of the By-Law shall apply.
Not Available	A-4	Notwithstanding any provisions of this By-Law to the contrary, within any area <i>zoned</i> A-4 on Schedule “A” hereto, in addition to the <i>uses</i> permitted in the Agricultural (A) Zone, the storage and repair of amusement rides and equipment limited to a maximum <i>lot coverage</i> of 30 percent shall also be permitted. All other requirements of the By-Law shall apply.
95-05	A-5	Notwithstanding any provisions of this By-Law to the contrary, within any area <i>zoned</i> A-5 on Schedule “A” hereto, in addition to the <i>uses</i> permitted in the Agricultural (A) Zone, a dental clinic shall also be permitted. All other requirements of the By-Law shall apply.

SECTION 6: AGRICULTURAL (A) ZONE

By-Law No.	Zone Code	Description
Not Available	A-6	Notwithstanding any provisions of this By-Law to the contrary, within any area <i>zoned</i> A-6 on Schedule “A” hereto, in addition to the <i>uses</i> permitted in the Agricultural (A) Zone, a <i>kennel</i> and/or a <i>boarding facility kennel</i> with a maximum capacity of 30 dogs shall also be permitted. All other requirements of the By-Law shall apply.
196-13 18-05	A-7	Notwithstanding any provisions of this By-Law to the contrary, within any area <i>zoned</i> A-7 on Schedule “A” hereto, no <i>livestock</i> shall be permitted. All other requirements of the By-Law shall apply.
Not Available	A-8	Notwithstanding any provisions of this By-Law to the contrary, within any area <i>zoned</i> A-8 on Schedule “A” hereto, in addition to the <i>uses</i> permitted in the Agricultural (A) Zone, a business involving the installation of playground equipment and the retailing and installation of industrial, residential and farm fencing shall also be permitted. All other requirements of the By-Law shall apply.
Various	A-9	Notwithstanding the provisions of this By-Law to the contrary, within any area <i>zoned</i> A-9 on Schedule “A” hereto, no <i>dwelling unit</i> shall be permitted. All other requirements of the By-Law shall apply.
89-13 121-02	A-10	Notwithstanding any provisions of this By-Law to the contrary, within any area <i>zoned</i> A-10 on Schedule “A” hereto, in addition to the <i>uses</i> permitted in the Agricultural (A) Zone, a maximum of three <i>single detached dwelling units</i> shall also be permitted. All other requirements of the By-Law shall apply.
Not Available	A-11	Notwithstanding any provisions of this By-Law to the contrary, within any area <i>zoned</i> A-11 on Schedule “A” hereto, the number of <i>livestock</i> units permitted shall be limited to 48. The warehousing and retailing of <i>livestock</i> feed not exceeding a <i>gross floor area</i> of 112 square metres shall also be permitted. Furthermore, no <i>poultry uses</i> are permitted. The <i>setbacks</i> between a <i>livestock</i> barn, a <i>feedlot area</i> , and a manure storage facility shall be located a minimum of 90 metres to the nearest residence and have a minimum <i>setback</i> of 30 metres from any <i>lot line</i> . All other requirements of the By-Law shall apply.
52-13	A-12	Notwithstanding any provisions of this By-Law to the contrary, within any area <i>zoned</i> A-12 on Schedule “A” hereto, in addition to the <i>uses</i> permitted in the Agricultural (A) Zone, a horse <i>riding arena</i> , a horse riding academy and a horse training centre shall also be permitted. All other requirements of the By-Law shall apply.

SECTION 6: AGRICULTURAL (A) ZONE

By-Law No.	Zone Code	Description
121-02	A-13	Notwithstanding any provisions of this By-Law to the contrary, within any area <i>zoned</i> A-13 on Schedule “A” hereto, in addition to the <i>uses</i> permitted in the Agricultural (A) Zone, a <i>service shop</i> shall also be permitted. All other requirements of the By-Law shall apply.
Not Available	A-14	Notwithstanding any provisions of this By-Law to the contrary, within any area <i>zoned</i> A-14 on Schedule “A” hereto, in addition to the <i>uses</i> permitted in the Agricultural (A) Zone, a <i>livestock sales market</i> shall also be permitted. All other requirements of the By-Law shall apply.
Not Available	A-15	Notwithstanding any provisions of this By-Law to the contrary, within any area <i>zoned</i> A-15 on Schedule “A” hereto, in addition to the <i>uses</i> permitted in the Agricultural (A) Zone, a feed and/or <i>flour mill</i> operation shall also be permitted. All other requirements of the By-Law shall apply.
Not Available	A-16	Notwithstanding any provisions of this By-Law to the contrary, within any area <i>zoned</i> A-16 on Schedule “A” hereto, in addition to the <i>uses</i> permitted in the Agricultural (A) Zone, a manufacturing and fabrication plant for farm and construction related equipment as well as bulk kilns, portable <i>buildings</i> and farm produce handling equipment and related retail sales shall also be permitted. All other requirements of the By-Law shall apply.
Not Available	A-17	Notwithstanding any provisions of this By-Law to the contrary, within any area <i>zoned</i> A-17 on Schedule “A” hereto, in addition to the <i>uses</i> permitted in the Agricultural (A) Zone, the manufacturing and fabrication of metal and concrete products including a <i>warehouse</i> , an outside storage area of 550 square metres, and a <i>wholesale establishment</i> and <i>business office accessory</i> to a permitted <i>use</i> shall also be permitted. All other requirements of the By-Law shall apply.
Not Available	A-18	Notwithstanding any provisions of this By-Law to the contrary, within any area <i>zoned</i> A-18 on Schedule “A” hereto, in addition to the <i>uses</i> permitted in the Agricultural (A) Zone, an <i>abattoir</i> shall also be permitted. All other requirements of the By-Law shall apply.
Not Available	A-19	Notwithstanding any provisions of this By-Law to the contrary, within any area <i>zoned</i> A-19 on Schedule “A” hereto, the number of <i>livestock</i> units permitted is limited to eight. Furthermore, the <i>building or structure used</i> for the raising/housing of horses and/or cattle shall be <i>setback</i> a minimum of 10 metres from the <i>street line</i> abutting County Road No. 4. All other requirements of the By-Law shall apply.

SECTION 6: AGRICULTURAL (A) ZONE

By-Law No.	Zone Code	Description
Not Available	A-20	Notwithstanding any provisions of this By-Law to the contrary, within any area zoned A-20 on Schedule "A" hereto, in addition to the <i>uses</i> permitted in the Agricultural (A) Zone, a <i>transport/truck terminal</i> shall also be permitted. All other requirements of the By-Law shall apply.
121-02	A-21	Notwithstanding any provisions of this By-Law to the contrary, within any area zoned A-21 on Schedule "A" hereto, in addition to the <i>uses</i> permitted in the Agricultural (A) Zone, a <i>fish farm</i> shall also be permitted. All other requirements of the By-Law shall apply.
Not Available	A-22	Notwithstanding any provisions of this By-Law to the contrary, within any area zoned A-22 on Schedule "A" hereto, in addition to the <i>uses</i> permitted in the Agricultural (A) Zone, a <i>salvage yard</i> shall also be permitted. All other requirements of the By-Law shall apply.
Not Available	A-23	Notwithstanding any provisions of this By-Law to the contrary, within any area zoned A-23 on Schedule "A" hereto, in addition to the <i>uses</i> permitted in the Agricultural (A) Zone, an <i>automobile repair garage</i> and <i>vehicle</i> sales establishment shall also be permitted. All repairs shall be confined to the interior of <i>existing buildings</i> and the storage of <i>vehicles</i> for sale shall be limited to a maximum of 6 <i>vehicles</i> . All other requirements of the By-Law shall apply.
Not Available	A-24	Notwithstanding any provisions of this By-Law to the contrary, within any area zoned A-24 on Schedule "A" hereto, the <i>livestock use</i> shall be restricted to a maximum of 5 horses or cattle. A maximum of ten (10) calves and/or colts shall be recognized as a permitted <i>use</i> on the <i>lot</i> . All other requirements of the By-Law shall apply.
121-02	A-25	Notwithstanding any provisions of this By-Law to the contrary, within any area zoned A-25 on Schedule "A" hereto, in addition to the <i>uses</i> permitted in the Agricultural (A) Zone, the fabrication of wood products and a meat cutting shop/butcher shall also be permitted. The butcher shop is a <i>building</i> or part of a <i>building</i> in which animal meats can be cut, sectioned and prepared for wholesale or retail purposes. The slaughtering and killing of animals, however, are strictly prohibited on the premises. All other requirements of the By-Law shall apply.

SECTION 6: AGRICULTURAL (A) ZONE

By-Law No.	Zone Code	Description
Not Available	A-26	Notwithstanding any provisions of this By-Law to the contrary, within any area zoned A-26 on Schedule "A" hereto, in addition to the uses permitted in the Agricultural (A) Zone, the parking, storage and maintenance only of <i>vehicles</i> for a caterer's establishment shall also be permitted. All other requirements of the By-Law shall apply.
Not Available	A-27	Notwithstanding any provisions of this By-Law to the contrary, within any area zoned A-27 on Schedule "A" hereto, in addition to the uses permitted in the Agricultural (A) Zone, an automobile supply store shall also be permitted. All other requirements of the By-Law shall apply.
Not Available	A-28	Notwithstanding any provisions of this By-Law to the contrary, within any area zoned A-28 on Schedule "A" hereto, in addition to the uses permitted in the Agricultural (A) Zone, a <i>research and development establishment</i> including 8 <i>dwelling units</i> directly related to the research station and the use of one of the <i>dwelling units</i> as a <i>lodging house</i> shall also be permitted. All other requirements of the By-Law shall apply.
Not Available	A-29	Notwithstanding any provisions of this By-Law to the contrary, within any area zoned A-29 on Schedule "A" hereto, in addition to the uses permitted in the Agricultural (A) Zone, a <i>building</i> with a maximum <i>gross floor area</i> of 750 square metres containing a <i>service shop</i> with a maximum <i>gross floor area</i> of 120 square metres, housing for a maximum of 5 horses and a maximum of 1,200 rabbits shall also be permitted. The <i>building</i> must be located 6.7 metres from the north <i>lot line</i> and 58 metres from the nearest adjoining residence. All other requirements of the By-Law shall apply.
93-51P	A-30	Notwithstanding any provisions of this By-Law to the contrary, within any area zoned A-30 on Schedule "A" hereto, in addition to the uses permitted in the Agricultural (A) Zone, a <i>research and development establishment</i> shall also be permitted. All other requirements of the By-Law shall apply.
Not Available	A-31	Notwithstanding any provisions of this By-Law to the contrary, within any area zoned A-31 on Schedule "A" hereto, in addition to the uses permitted in Agricultural (A) Zone, a Heritage and Tourism business with a workshop for the creation of heritage artifacts, craft shop producing and/or selling heritage items, tea room, storage and display of heritage items and a <i>bed and breakfast establishment</i> shall also be permitted. All uses shall be confined to the <i>existing building</i> . The craft shop shall be limited to a maximum <i>gross floor area</i> of 100 sq. mt. and the tea room shall be limited to a maximum <i>gross floor area</i> of 50 sq. mt. All other requirements of the By-Law shall apply.

SECTION 6: AGRICULTURAL (A) ZONE

By-Law No.	Zone Code	Description
Not Available	A-32	Notwithstanding any provisions of this By-Law to the contrary, within any area zoned A-32 on Schedule "A" hereto, in addition to the <i>uses</i> permitted in the Agricultural (A) Zone, a <i>food processing plant</i> for mushrooms confined to the interior of the <i>existing buildings and structures</i> shall also be permitted. No outside storage shall be permitted. All other requirements of the By-Law shall apply.
Not Available	A-33	Notwithstanding any provisions of this By-Law to the contrary, within any area zoned A-33 on Schedule "A" hereto, the <i>uses</i> permitted shall be limited to an <i>automobile repair garage</i> having a maximum <i>gross floor area</i> of 750 square metres. Outside storage shall be limited to 1000 square metres and shall not be located in the <i>front yard</i> . All other requirements of the By-Law shall apply.
53-03	A-34	Notwithstanding any provisions of this By-Law to the contrary, within any area zoned A-34 on Schedule "A" hereto, the maximum number of <i>livestock</i> units permitted shall be six (6). All other requirements of the By-Law shall apply.
95-05	A-35	Notwithstanding any provisions of this By-Law to the contrary, within any area zoned A-35 on Schedule "A" hereto, in addition to the <i>uses</i> permitted in the Agricultural (A) Zone, the retailing of antiques in an <i>existing building or structure</i> shall also be permitted. All other requirements of the By-Law shall apply.
Not Available	A-36	Notwithstanding any provisions of this By-Law to the contrary, within any area zoned A-36 on Schedule "A" hereto, in addition to the <i>uses</i> permitted in the Agricultural (A) Zone, an <i>agricultural service and supply establishment</i> shall also be permitted. All other requirements of the By-Law shall apply.
95-05	A-37	Notwithstanding any provisions of this By-Law to the contrary, within any area zoned A-37 on Schedule "A" hereto, in addition to the <i>uses</i> permitted in the Agricultural (A) Zone, a <i>commercial greenhouse</i> not exceeding <i>lot coverage</i> of 30% shall also be permitted. All other requirements of the By-Law shall apply.
Not Available	A-38	Notwithstanding any provisions of this By-Law to the contrary, within any area zoned A-38 on Schedule "A" hereto, in addition to the <i>uses</i> permitted in the Agricultural (A) Zone, a petting zoo, hay rides and pony rides shall also be permitted. All other requirements of the By-Law shall apply.

SECTION 6: AGRICULTURAL (A) ZONE

By-Law No.	Zone Code	Description
Not Available	A-39	Notwithstanding any provisions of this By-Law to the contrary, within any area zoned A-39 on Schedule "A" hereto, in addition to the <i>uses</i> permitted in the Agricultural (A) Zone, an <i>automobile repair garage</i> with a maximum <i>building gross floor area</i> of 260 square metres shall also be permitted. However, no <i>vehicles</i> awaiting repair or pick-up shall be parked in any <i>side yard</i> or <i>front yard</i> . Outdoor storage shall not be permitted. All other requirements of the By-Law shall apply.
Not Available	A-40	Notwithstanding any provisions of this By-Law to the contrary, within any area zoned A-40 on Schedule "A" hereto, in addition to the <i>uses</i> permitted in the Agricultural (A) Zone, an <i>automobile repair garage</i> with a maximum <i>building gross floor area</i> of 260 square metres shall also be permitted. Any outside storage shall be limited to 2,200 square metres and shall be located to the east of the commercial <i>building</i> . The <i>use</i> of the outside storage area shall be limited only to parking for <i>vehicles</i> and equipment actively being serviced and for parts necessary for such repair work. The outside perimeter of the storage area shall be enclosed with a 2 metre high privacy fence. All other requirements of the By-Law shall apply.
Not Available	A-41	Notwithstanding any provisions of this By-Law to the contrary, within any area zoned A-41 on Schedule "A" hereto, in addition to the <i>uses</i> permitted in the Agricultural (A) Zone, a four-unit <i>apartment dwelling</i> shall also be permitted. All other requirements of the By-Law shall apply.
Not Available	A-42	Notwithstanding any provisions of this By-Law to the contrary, within any area zoned A-42 on Schedule "A" hereto, in addition to the <i>uses</i> permitted in the Agricultural (A) Zone, a maximum of two (2) <i>semi-detached dwelling units</i> shall also be permitted. All other requirements of the By-Law shall apply.
Not Available	A-43	Notwithstanding any provisions of this By-Law to the contrary, within any area zoned A-43 on Schedule "A" hereto, in addition to the <i>uses</i> permitted in the Agricultural (A) Zone, the storage of <i>school buses</i> , maintenance and dispatch, together with <i>uses, buildings</i> and <i>structures accessory</i> thereto shall also be permitted. All other requirements of the By-Law shall apply.

SECTION 6: AGRICULTURAL (A) ZONE

By-Law No.	Zone Code	Description
Not Available	A-44	Notwithstanding any provisions of this By-Law to the contrary, within any area zoned A-44 on Schedule "A" hereto, in addition to the <i>uses</i> permitted in the Agricultural (A) Zone, the processing of ginseng into ginseng products such as candy and the retailing of ginseng products, candy, specialty cheeses and other agriculturally oriented produce shall also be permitted. The maximum <i>gross floor area</i> for the processing operation shall be 160 square metres and a maximum <i>floor area</i> for the <i>retail store</i> shall be 38 square metres. Retailing shall be confined to the interior of the <i>existing structures</i> . All other requirements of the By-Law shall apply.
169-15	A-45	Notwithstanding anything in this By-Law to the contrary, within any area zoned A-45 on Schedule "A" hereto, a mink farm to a maximum of 50 <i>livestock</i> units shall be a permitted <i>use</i> provided that any <i>livestock building</i> is located no closer than 244 metres from any <i>dwelling</i> built before December 14, 1998 and 14 metres from any <i>lot line</i> . All other requirements of the By-Law shall apply.
121-02	A-46	Notwithstanding any provisions of this By-Law to the contrary, within any area zoned A-46 on Schedule "A" hereto, a maximum <i>lot coverage</i> of forty percent (40%) shall apply of which twenty two percent (22%) may be <i>used</i> for <i>agricultural uses</i> and eighteen percent (18%) may be <i>used</i> for other <i>uses</i> . All other requirements of the By-Law shall apply.
121-02	A-47	Notwithstanding any provisions of this By-Law to the contrary, within any area zoned A-47 on Schedule "A" hereto, in addition to the <i>uses</i> permitted in the Agricultural (A) Zone, an apartment/ additional <i>dwelling unit</i> within the <i>existing single detached dwelling</i> shall also be permitted. All other requirements of the By-Law shall apply.
121-02	A-48	Notwithstanding any provisions of this By-Law to the contrary, within any area zoned A-48 on Schedule "A" hereto, in addition to the <i>uses</i> permitted in the Agricultural (A) Zone, a farm supply centre and machinery repair shop shall also be permitted. All other requirements of the By-Law shall apply.

SECTION 6: AGRICULTURAL (A) ZONE

By-Law No.	Zone Code	Description
95-05	A-49	Notwithstanding any provisions of this By-Law to the contrary, within any area <i>zoned</i> A-49 on Schedule "A" hereto, in addition to the <i>uses</i> permitted in the Agricultural (A) Zone, a workshop for the teaching of ceramic arts and sales of ceramics shall also be permitted. The active work area of said <i>use</i> shall not exceed 70 square metres, with the balance of the <i>existing building's floor area</i> being <i>used</i> for storage related to the business. Not more than 5 <i>parking spaces</i> are to be located on the site. All other requirements of the By-Law shall apply.
51-03	A-50	Notwithstanding any provisions of this By-Law to the contrary, within any area <i>zoned</i> A-50 on Schedule 'A' hereto, a <i>boarding facility kennel</i> is a permitted <i>use</i> . The <i>boarding facility kennel</i> shall be <i>setback</i> at least 50 metres from any <i>lot line</i> . All other requirements of the By-Law shall apply.
116-03	A-51	Notwithstanding any provisions of this By-Law to the contrary, within any area <i>zoned</i> A-51 on Schedule 'A' hereto, a <i>kennel</i> limited to ten (10) dogs shall also be permitted. All other requirements of the By-Law shall apply.
159-03	A-52	Notwithstanding any provisions of this By-Law to the contrary, within any area <i>zoned</i> A-52 on Schedule 'A' hereto, a fence contracting business, limited to a 374 square metre <i>building</i> and outside storage area limited to a 98 square metre south of the aforementioned <i>building</i> , and limited to a maximum of eight (8) employees, and operating only between March 1 and October 31, shall also be permitted. All other requirements of the By-Law shall apply.
181-03	A-53	Notwithstanding any provisions of this By-Law to the contrary, within any area <i>zoned</i> A-53 on Schedule 'A' hereto, an <i>auto body shop</i> shall also be permitted. All other requirements of the By-Law shall apply.
22-16	A-54	Notwithstanding the provisions of Section 4 of this By-Law to the contrary, within any area <i>zoned</i> A-54 on Schedule "A" hereto, in addition to the <i>uses</i> permitted in the Agricultural (A) Zone, a <i>fertilizer blending station</i> shall also be permitted. All other requirements of the By-Law shall apply.

SECTION 6: AGRICULTURAL (A) ZONE

By-Law No.	Zone Code	Description
244-03	A-55	Notwithstanding any provision in this By-Law to the contrary, within any area <i>zoned</i> A-55 on Schedule 'A' hereto, no <i>livestock building</i> or manure storage facility shall be located within 333 metres of Hammond Road. All other requirements of the By-Law shall apply.
13-04	A-56	Notwithstanding any provision in this By-Law to the contrary, within any area <i>zoned</i> A-56 on Schedule 'A' hereto, the minimum <i>front yard</i> depth shall be: <ul style="list-style-type: none"> a) for a residential use: 215 meters b) Intensive <i>livestock buildings</i> and <i>mushroom operations</i>: 260 metres or the distance required by the <i>Minimum Distance Separation Guidelines</i>, whichever is greater c) all other <i>uses</i>: 225 meters d) <i>Front yard</i> shall be measured parallel to the western <i>lot</i> boundary. All other requirements of the By-Law shall apply.
123-04	A-57	Notwithstanding any provision of this By-Law to the contrary, within any area <i>zoned</i> A-157 on Schedule "A" hereto, no <i>dwelling</i> shall be <i>erected</i> within 157 metres of the <i>existing livestock building</i> located at 66 Harris Road. All other requirements of the By-Law shall apply.
174-04	A-58	Notwithstanding any provision of this By-Law to the contrary, within any area <i>zoned</i> A-58 on Schedule "A" hereto, a <i>boarding facility kennel</i> for a maximum of ten (10) dogs and for the daytime only boarding of an additional ten (10) dogs shall be a permitted use. All other requirements of the By-Law shall apply.
175-04	A-59	Notwithstanding any provision of this By-Law to the contrary, within any area <i>zoned</i> A-59 on Schedule "A" hereto, up to, but not more than, five (5) people who do not reside on this <i>lot</i> , may attend or work at a rural <i>home occupation</i> . All other requirements of the By-Law shall apply.
95-05	A-60	Notwithstanding any provisions of this By-Law to the contrary, within any area <i>zoned</i> A-60 on Schedule "A" hereto, in addition to the <i>uses</i> permitted in the Agricultural (A) Zone, an <i>automobile repair garage</i> shall also be permitted. Said <i>automobile repair garage</i> shall be located in the <i>existing</i> barn and no outside storage shall be permitted. All other requirements of the By-Law shall apply.

SECTION 6: AGRICULTURAL (A) ZONE

By-Law No.	Zone Code	Description
95-05	A-61	Notwithstanding any provisions of this By-Law to the contrary, within any area zoned A-61 on Schedule "A" hereto, in addition to the <i>uses</i> permitted in the Agricultural (A) Zone, <i>automobile repair garage</i> and a <i>restaurant</i> shall also be permitted in an <i>existing building</i> or <i>structure</i> . All other requirements of the By-Law shall apply.
55-05	A-62	Notwithstanding any provision of this By-Law to the contrary, within any area zoned A-62 on Schedule "A" hereto, two (2) <i>dwelling units</i> shall be permitted provided that they are in a single <i>structure</i> and the said <i>structure</i> is subject to the <i>setback</i> regulations of a <i>single-detached dwelling</i> . All other requirements of the By-Law shall apply.
79-09	A-63	Notwithstanding any provision of this By-Law to the contrary, within any area zoned A-63 on Schedule "A" hereto, no <i>livestock</i> barn shall exceed a maximum <i>floor area</i> of 1,505 square metres and no <i>livestock</i> barn shall be located no closer than 320 metres to a <i>street</i> and no closer than 270 metres to the western <i>side yard</i> . All other requirements of the By-Law shall apply.
100-05	A-64	Notwithstanding any provision of this By-Law to the contrary, within any area zoned A-64 on Schedule A hereto, a <i>single detached dwelling</i> within an <i>existing structure</i> shall be permitted. All other requirements of the By-Law shall apply.
83-06 50-13	A-65	Notwithstanding any provision of this By-Law to the contrary, within any area zoned A-65 on Schedule "A" hereto, the maximum number of <i>livestock</i> units permitted shall be five (5). All other requirements of the By-Law shall apply.
193-05	A-66	Notwithstanding any provision of this By-Law to the contrary, within any area zoned A-66 on Schedule "A" hereto, a maximum of four (4) <i>single detached dwelling units</i> shall be permitted. All other requirements of the By-Law shall apply.
163-06	A-67	Notwithstanding any provision of this By-Law to the contrary, within any area zoned A-67 on Schedule "A" hereto, in addition to the <i>uses</i> permitted in the Agricultural (A) Zone, a <i>kennel</i> with a maximum of twenty (20) dogs shall be a permitted <i>use</i> . All other requirements of the By-Law shall apply.

SECTION 6: AGRICULTURAL (A) ZONE

By-Law No.	Zone Code	Description
33-10, 60-09	A-68	Notwithstanding any provision of this By-Law to the contrary, within any area zoned A-68 on Schedule "A" hereto, in addition to the <i>uses</i> permitted in the Agricultural (A) Zone, <i>vehicle</i> safety checks and <i>vehicle</i> repairs performed on trucks, tractor <i>trailers</i> and farm equipment shall be permitted. For the purpose of this By-Law, <i>vehicle</i> excludes body work and painting of <i>vehicles</i> and excludes work performed on passenger cars and light trucks. All other requirements of the By-Law shall apply.
115-08	A-69	Notwithstanding any provision of this By-Law to the contrary, within any area zoned A-69 on Schedule "A" hereto, a <i>boarding facility kennel</i> for a maximum of forty (40) dogs, with no more than 5 employees who do not reside in the <i>dwelling</i> shall also be permitted. No <i>building</i> or fenced area associated with the <i>boarding facility kennel</i> shall be closer than 25 metres to any <i>lot line</i> . All other requirements of the By-Law shall apply.
92-11	A-70	Notwithstanding any provision of this By-law to the contrary, within any area zoned A-70 on Schedule "A" hereto, a boarding <i>kennel</i> with a maximum of thirty (30) dogs in the <i>main dwelling</i> only shall also be permitted. As well, a maximum of three (3) boarding dogs will be permitted in the outdoor fenced area at any time. All other requirements of the By-Law shall apply.
38-09	A-71	Notwithstanding any provision of this By-Law to the contrary, within any area zoned A-71 on Schedule "A" hereto, the permitted <i>uses</i> are limited to a telecommunications tower and <i>accessory buildings</i> and <i>structures</i> . The minimum <i>lot area</i> shall be 0.9 hectares and the minimum <i>lot frontage</i> shall be 40 metres. All other requirements of the By-Law shall apply.
106-09	A-72	Notwithstanding any provision of this By-Law to the contrary, within any area zoned A-72 on Schedule "A" hereto, a <i>boarding facility kennel</i> for a maximum of sixteen (16) dogs and for the daytime only boarding of an additional five (5) dogs, a grooming facility and a training facility shall be permitted <i>uses</i> . All other requirements of the By-Law shall apply.
31-10	A-73	Notwithstanding any provision of this By-Law to the contrary, within any area zoned A-73 on Schedule "A" hereto, in addition to the <i>uses</i> permitted in the Agricultural (A) Zone, a grain elevator, washing and drying <i>use</i> shall also be permitted. All other requirements of the By-Law shall apply.

SECTION 6: AGRICULTURAL (A) ZONE

By-Law No.	Zone Code	Description
251-10	A-74	Notwithstanding any provisions of this By-law to the contrary, within any area <i>zoned</i> A-74 on Schedule "A" hereto, in addition to the <i>uses</i> permitted in the Agricultural (A) Zone, a business involving service, installation and storage of windows, contained wholly within the <i>accessory building</i> not exceeding a maximum <i>gross floor area</i> of 150 square meters shall also be permitted. All other requirements of the By-Law shall apply.
46-11	A-75	Notwithstanding any provision of this By-Law to the contrary, within any area <i>zoned</i> A-75 on Schedule "A" hereto, a dog <i>kennel</i> restricted to six (6) adult dogs shall also be permitted. The minimum <i>setback</i> for the dog <i>kennel</i> and eight (8) acoustically shielded outdoor dog runs shall be 100 metres from any residential <i>use</i> on an abutting <i>lot</i> . All other requirements of the By-Law shall apply.
80-11	A-76	Notwithstanding any provisions of this By-Law to the contrary, within any area <i>zoned</i> A-76 on Schedule "A" hereto, in addition to the <i>uses</i> permitted by the Agricultural (A) Zone, a horse <i>riding arena</i> , a horse training and boarding facility with a maximum of 60 horses shall also be permitted. All other requirements of the By-Law shall apply.
139-11	A-77	Notwithstanding any provision of this By-Law to the contrary, within any area <i>zoned</i> A-77 on Schedule "A" hereto, in addition to the permitted <i>uses</i> , a <i>boarding facility kennel</i> with a maximum of 20 dogs and operating only between of 0700 and 1800 shall also be permitted. All other requirements of the By-Law shall apply.
180-11	A-78	Notwithstanding anything in this By-Law to the contrary within an area <i>zoned</i> A-78 on Schedule "A" hereto, no part of any <i>dwelling</i> shall be located more than 115 metres from the southern limit of Brant-Waterloo Road. All other requirements of the By-Law shall apply.
206-11	A-79	Notwithstanding any provision of this By-Law to the contrary, within any area <i>zoned</i> A-79 on Schedule "A" hereto, in addition to the <i>uses</i> permitted in the Agricultural (A) Zone, the keeping of <i>livestock</i> shall not exceed a quantity equivalent to two (2) Nutrient Units as defined in the <i>MDS Guidelines</i> shall be permitted. All other requirements of the By-Law shall apply.

SECTION 6: AGRICULTURAL (A) ZONE

By-Law No.	Zone Code	Description
62-14	A-80	Notwithstanding any provision of this By-Law to the contrary, within any area <i>zoned</i> A-80 on Schedule “A” hereto, in addition to the <i>uses</i> permitted in the Agricultural (A) Zone, farm equipment repair and a <i>recreational vehicle</i> service and repair establishment shall also be permitted. All other requirements of the By-Law shall apply.
Not Available	A-81	Notwithstanding any provisions of this By-Law to the contrary, within any area <i>zoned</i> A-81 on Schedule “A” hereto, an <i>existing</i> chicken broiler operation shall also be permitted. All other requirements of the By-Law shall apply.
Not Available	A-82	Notwithstanding any provisions of this By-Law to the contrary, within any area <i>zoned</i> A-82 on Schedule “A” hereto, in addition to the <i>uses</i> permitted in the Agricultural (A) Zone, a <i>wholesale establishment</i> for vending supplies having a maximum <i>gross floor area</i> of 600 square metres shall also be permitted. No outside storage is permitted except for the parking of <i>vehicles</i> directly related to the vending business within an area no greater than 75 square metres. All other requirements of the By-Law shall apply.
Not Available	A-83	Notwithstanding any provisions of this By-Law to the contrary, within any area <i>zoned</i> A-83 on Schedule “A” hereto, in addition to the <i>uses</i> permitted in the Agricultural (A) Zone, a horse <i>livestock</i> barn and <i>riding arena</i> with a maximum of six horses shall also be permitted. Any associated <i>building</i> shall be subject to the following requirements: <ul style="list-style-type: none"> a) a minimum of 38 metres from the <i>front lot line</i>, b) a minimum of 15 metres from the southerly <i>lot line</i>, c) a minimum of 7.6 metres from the <i>rear lot line</i>, and d) a minimum of 30 metres from the northerly <i>interior lot line</i>. All other requirements of the By-Law shall apply.
Not Available	A-84	Notwithstanding any provisions of this By-Law to the contrary, within any area <i>zoned</i> A-84 on Schedule “A” hereto, a horse <i>riding arena</i> and horse training centre with the maximum of four horses shall also be permitted. All other requirements of the By-Law shall apply.

SECTION 6: AGRICULTURAL (A) ZONE

By-Law No.	Zone Code	Description
Not Available	A-85	Notwithstanding any provisions of this By-Law to the contrary, within any area <i>zoned</i> A-85 on Schedule “A” hereto, a <i>veterinary clinic</i> shall also be permitted. However, no outside storage or <i>kennels</i> are permitted. All other requirements of the By-Law shall apply.
Not Available	A-86	Notwithstanding any provisions of this By-Law to the contrary, within any area <i>zoned</i> A-86 on Schedule “A” hereto, a <i>kennel</i> with a maximum of 20 dogs shall also be permitted. The <i>kennel</i> and the dog runs must be located at a minimum of 30 metres from the nearest residence. The maximum <i>gross floor area</i> of the <i>kennel</i> shall be 20 square metres. The number of pens shall be restricted to four inside pens and 2 outside runs and there shall be no boarding of dogs. All other requirements of the By-Law shall apply.
178-11	A-87	Notwithstanding any provisions of this By-Law to the contrary within an area <i>zoned</i> A-87 on Schedule “A” hereto, a business involved in selling saddles, bridles, tack, riding wear, and other related equestrian goods and paraphernalia, limited to 2,309 square metres shall also be permitted. The <i>buildings</i> and <i>structures</i> related to the business <i>use</i> shall be located to the west of a line coincident with a southerly project of the centre line of Madeleine Road. All other requirements of the By-Law shall apply.
Not Available	A-88	Notwithstanding any provisions of this By-Law to the contrary, within any area <i>zoned</i> A-88 on Schedule “A” hereto, a horse farm operation with a maximum of 12 horses shall also be permitted. All other requirements of the By-Law shall apply.
Not Available	A-89	Notwithstanding any provisions of this By-Law to the contrary, within any area <i>zoned</i> A-89 on Schedule “A” hereto, an <i>agricultural service and supply establishment</i> shall also be permitted. All other requirements of the By-Law shall apply.
121-02, 86-10	A-90	Notwithstanding any provisions of this By-Law to the contrary, within any area <i>zoned</i> A-90 on Schedule “A” hereto, in addition to the <i>uses</i> permitted in the Agricultural (A) Zone, a metal manufacturing and fabrication plant as well as bulk kilns, portable <i>buildings</i> and farm produce handling equipment and related retail sales shall also be permitted. All other requirements of the By-Law shall apply.

SECTION 6: AGRICULTURAL (A) ZONE

By-Law No.	Zone Code	Description
Not Available	A-91	<p>Notwithstanding any provisions of this By-Law to the contrary, within any area <i>zoned</i> A-91 on Schedule “A” hereto, the parking of transport trucks within an area measuring 185 square metres shall also be permitted.</p> <p>A truck maintenance shop with a maximum <i>gross floor area</i> of 92 square metres shall also be permitted.</p> <p>No truck <i>parking area</i> and no maintenance shop shall be located within 30 metres of the westerly <i>side yard</i>.</p> <p>A maximum of 3 <i>transport trucks</i> (3 tractors and 3 <i>trailers</i>) may be located on the lands.</p> <p>No parts or materials shall be stored or kept outside the <i>building</i>.</p> <p>All maintenance work conducted on the trucks shall be confined to inside the maintenance shop <i>building</i>.</p> <p>All other requirements of the By-Law shall apply.</p>
80-07	A-92	<p>Notwithstanding any provision of this By-Law to the contrary, within any area <i>zoned</i> A-92 on Schedule “A” hereto, an <i>existing</i> trucking business as described below shall also be permitted.</p> <ol style="list-style-type: none"> a) The business involves storage and maintenance of trucks b) The time of operation shall be limited to Monday to Friday from 08:00 to 16:00 hours and Saturday from 08:00 to 12:00 hours. c) The business shall be limited to approximately 2 hectares of the total land area and shall contain the following <i>buildings</i>: <ol style="list-style-type: none"> (i) Shop for maintenance and repair: 223.0 square metres (ii) A farm machine shed: 465 square metres (iii) Farm house residence including office associated with the business: 325 square metres (iv) Rental house: 112 square metres d) Maximum number of employees: 5 <p>All other requirements of the By-Law shall apply.</p>
79-03	A-93	<p>Notwithstanding any provisions of this By-Law to the contrary, within any area <i>zoned</i> A-93 on Schedule “A” hereto, the maximum number of <i>livestock</i> units permitted shall be 100. Furthermore, three (3) <i>single detached dwellings</i> shall also be permitted. All other requirements of the By-Law shall apply.</p>
74-03	A-94	<p>Notwithstanding any provisions of this By-Law to the contrary, within any area <i>zoned</i> A-94 on Schedule “A” hereto, the maximum number of <i>livestock</i> units permitted shall be 110. All other requirements of the By-Law shall apply.</p>

SECTION 6: AGRICULTURAL (A) ZONE

By-Law No.	Zone Code	Description
75-03	A-95	Notwithstanding any provisions of this By-Law to the contrary, within any area <i>zoned</i> A-95 on Schedule “A” hereto, the maximum number of <i>livestock</i> units permitted shall be 100. All other requirements of the By-Law shall apply.
81-03	A-96	Notwithstanding any provisions of this By-Law to the contrary, within any area <i>zoned</i> A-96 on Schedule “A” hereto, the maximum number of <i>livestock</i> units permitted shall be 70. All other requirements of the By-Law shall apply.
84-03	A-97	Notwithstanding any provisions of this By-Law to the contrary, within any area <i>zoned</i> A-97 on Schedule “A” hereto, the <i>existing</i> 200 <i>livestock</i> unit broiler operation (40,000 broilers) is recognized as a <i>legal non-conforming use</i> of land and an expansion of this broiler operation is permitted to accommodate an additional 200 <i>livestock</i> units. The spreading of manure on these lands and any outdoor storage of manure shall be prohibited. All other requirements of the By-Law shall apply.
179-03	A-98	Notwithstanding any provisions of this By-Law to the contrary, within any area <i>zoned</i> A-98 on Schedule ‘A’ hereto, a <i>boarding facility kennel</i> for cats and dogs shall be a permitted <i>use</i> . All other requirements of the By-Law shall apply.
80-07	A-99	Notwithstanding any provision of this By-Law to the contrary, within any area <i>zoned</i> A-99 on Schedule “A” hereto, no agricultural <i>buildings</i> or <i>structures</i> , including <i>livestock facilities</i> and <i>accessory buildings</i> or <i>structures</i> , or any part of a new <i>private</i> sewage disposal system and well shall be located more than 220 metres from the southern limit of Howell Road. All other requirements of the By-Law shall apply.
91-14	A-100	Notwithstanding any provision of this By-Law to the contrary, within any area <i>zoned</i> A-100 on Schedule “A” hereto, an automotive restoration and race car preparation business, having a maximum <i>gross floor area</i> of 450.5m ² contained within an <i>accessory structure</i> , and a maximum of 5 employees shall also be permitted. All other requirements of the By-Law shall apply.

SECTION 6: AGRICULTURAL (A) ZONE

By-Law No.	Zone Code	Description
130-14	A-101	Notwithstanding any provision of this By-Law to the contrary, within any area <i>zoned</i> A-101 on Schedule "A" hereto, an oversized <i>accessory structure</i> with a maximum <i>gross floor area</i> of 550 square metres <i>accessory</i> to the <i>existing rural home occupation</i> shall be permitted. The maximum total <i>gross floor area</i> for <i>buildings</i> or <i>structures</i> relating to the <i>home occupation</i> shall be 847 square metres. All other requirements of the By-Law shall apply.
Not Available	A-102	Notwithstanding any provisions of this By-Law to the contrary, within any area <i>zoned</i> A-102 on Schedule "A" hereto, a <i>kennel</i> restricted to a maximum of 20 dogs shall also be permitted. The <i>kennel</i> must be <i>setback</i> at least 61 metres from the <i>front lot line</i> . All other requirements of the By-Law shall apply.
Not Available	A-103	Notwithstanding any provisions of this By-Law to the contrary, within any area <i>zoned</i> A-103 on Schedule "A" hereto, a <i>single detached dwelling</i> used in conjunction with a saw mill operation shall also be permitted. All other requirements of the By-Law shall apply.
Not Available	A-104	Notwithstanding any provisions of this By-Law to the contrary, within any area <i>zoned</i> A-104 on Schedule "A" hereto, a <i>dwelling unit</i> shall not be permitted and a <i>veterinary clinic</i> shall be a permitted <i>use</i> . However, no outside storage or <i>kennels</i> are permitted. All other requirements of the By-Law shall apply.
Not Available	A-105	Notwithstanding any provisions of this By-Law to the contrary, within any area <i>zoned</i> A-105 on Schedule "A" hereto, a maximum of two <i>single detached dwelling units</i> shall also be permitted. Furthermore, a <i>contractor's yard</i> shall also be a permitted <i>use</i> . All other requirements of the By-Law shall apply.
Not Available	A-106	Notwithstanding any provisions of this By-Law to the contrary, within any area <i>zoned</i> A-106 on Schedule "A" hereto, a maximum of two <i>single detached dwelling units</i> shall also be permitted. Furthermore, the selling of antiques and the refurbishing of furniture shall also be permitted. This activity shall be confined to <i>buildings</i> and <i>structures</i> as they existed in August, 2001. All other requirements of the By-Law shall apply.

SECTION 6: AGRICULTURAL (A) ZONE

By-Law No.	Zone Code	Description
Not Available	A-107	Notwithstanding any provisions of this By-Law to the contrary, within any area <i>zoned</i> A-107 on Schedule “A” hereto, in addition to the <i>uses</i> permitted in the Agricultural (A) Zone, the storage and repair of automobiles and farm machinery and a <i>service shop</i> shall also be permitted. All other requirements of the By-Law shall apply.
Not Available	A-108	Notwithstanding any provisions of this By-Law to the contrary, within any area <i>zoned</i> A-108 on Schedule “A” hereto, a <i>service shop</i> and a <i>sawmill</i> shall be a permitted <i>use</i> . All other requirements of the By-Law shall apply.
95-05	A-109	Notwithstanding any provisions of this By-Law to the contrary, within any area <i>zoned</i> A-109 on Schedule “A” hereto, a <i>service shop</i> and a <i>contractor’s yard</i> shall be a permitted <i>use</i> . All other requirements of the By-Law shall apply.
150-06	A-110	Notwithstanding any provision of this By-Law to the contrary, within any area <i>zoned</i> A-110 on Schedule “A” hereto, access may be provided by an <i>easement</i> through the adjacent lands to the south. All other requirements of the By-Law shall apply.
Not Available	A-111	Notwithstanding any provisions of this By-Law to the contrary, within any area <i>zoned</i> A-111 on Schedule “A” hereto, in addition to the <i>uses</i> permitted in the Agricultural (A) Zone, a business involving the retail sales and installation of flooring from an <i>existing accessory</i> building shall also be permitted. All other requirements of the By-Law shall apply.
87-78Z	A-112	Notwithstanding any provisions of this By-Law to the contrary, within any area <i>zoned</i> A-112 on Schedule “A” hereto, in addition to the <i>uses</i> permitted in the Agricultural (A) Zone, a <i>kenel</i> shall also be permitted. All other requirements of the By-Law shall apply.
Not Available	A-113	Notwithstanding any provisions of this By-Law to the contrary, within any area <i>zoned</i> A-113 on Schedule “A” hereto, in addition to the <i>uses</i> permitted in the Agricultural (A) Zone, a film studio and the making and processing of films shall also be permitted. All other requirements of the By-Law shall apply.

SECTION 6: AGRICULTURAL (A) ZONE

By-Law No.	Zone Code	Description
175-12	A-114	Notwithstanding any provision of this By-Law to the contrary, within any area <i>zoned</i> A-114 on Schedule “A” hereto, in addition to the <i>uses</i> permitted in the Agricultural (A) Zone, a facility for horse riding instruction and public recreational horse riding shall also be permitted. Such activities shall be restricted to operation Monday to Friday, inclusive, with a maximum of twenty-five (25) riders at any time. Boarding of horses shall not be permitted. All other requirements of the By-Law shall apply.
71-12	A-115	Notwithstanding any provision of this By-Law to the contrary, within any area <i>zoned</i> A-115 on Schedule “A” hereto, an expanded <i>livestock facility</i> may be located no closer than 70 metres to the nearest off-site <i>dwelling</i> . All other requirements of the By-Law shall apply.
195-13, 80-15	A-116	Notwithstanding any provisions of this By-Law to the contrary, within any area <i>zoned</i> A-116 on Schedule “A” hereto, in addition to the <i>uses</i> permitted in the Agricultural (A) Zone, a <i>boarding facility kennel</i> with a maximum capacity of 25 animals (dogs and cats) shall also be permitted. All other requirements of the By-Law shall apply.
133-15	A-117	Notwithstanding any provision of this By-Law to the contrary, within any area <i>zoned</i> A-117 on Schedule “A” hereto, a secondary <i>dwelling unit</i> located within an <i>existing accessory structure</i> shall also be permitted as an accessory unit to the <i>existing single detached dwelling</i> . The total <i>gross floor area</i> of the secondary dwelling shall be limited to 112 square metres. All other requirements of the By-Law shall apply.
88-44Z	A-118	Notwithstanding the provisions of this By-Law to the contrary, within any area <i>zoned</i> A-118 on Schedule “A” hereto, in addition to the <i>uses</i> permitted in the Agricultural (A) Zone, the lands may also be used for a business involving the fabricating, distributing and retailing of products relating to horse farming. The products to be fabricated, distributed, and retail include products such as horse stable components, metal doors and grills for horse stalls, feed supplies for horses, wood shavings, etc. The said <i>uses</i> shall be limited to a maximum floor area of 604 square metres. All <i>uses</i> shall be confined to the interiors of buildings situated on the <i>lot</i> and no outside storage of <i>uses</i> shall be permitted. All other requirements of the By-Law shall apply.

SECTION 7: AGRICULTURAL EMPLOYMENT (AE) ZONE

7.1 Uses Permitted

No *person* shall within any Agricultural Employment (AE) Zone, use any *lot* or *erect, alter* or use any *building* or *structure* for any purpose except for one or more of the following *uses* as identified by a “dot”:

Table 7.1: Uses Permitted

List of Uses	Permitted
<i>Agricultural Service and Supply Establishment</i>	•
<i>Bulk Sales Establishment</i>	•
<i>Commercial Greenhouse</i>	•
<i>Contractor’s Yard</i>	•
<i>Dwelling, Single Detached accessory to the permitted use</i>	•
<i>Farm Production Outlet</i>	•
<i>Feed Mill</i>	•
<i>Fertilizer Blending Station</i>	•
<i>Agricultural Processing Facility</i>	•
<i>Forestry Use</i>	•
<i>Grain Elevator and Drying Facility</i>	•
<i>Livestock Sales Market</i>	•
<i>Lumber Mill</i>	•
<i>Medical Marijuana Production Facility</i>	•
<i>Nursery and Garden Centre</i>	•
<i>Shipping Container, in accordance with Section 4.35</i>	•
<i>Veterinary Clinic</i>	•

SECTION 7: AGRICULTURAL EMPLOYMENT (AE) ZONE

7.2 Zone Requirements

No *person* shall, within any Agricultural Employment (AE) *Zone*, use any *lot* or *erect, alter* or use any *building* or *structure* except in accordance with the following provisions:

Table 7.2: Zone Provisions

Provision	Specifications
Lot Area , Minimum (ha)	1
Lot Frontage , Minimum (metres)	30.0
Street Setback , Minimum (metres)*	9.0
Interior Side Yard Setback , Minimum (metres)*	3.0
Rear Yard Setback , Minimum (metres)*	9.0
Lot Coverage , Maximum	60%
Landscaped Open Space , Minimum	10%
Building Height , Maximum (metres)	12.0

*Notwithstanding the provisions stated above, in case of a *lot* abutting any Residential or Institutional *Zone*, the *street setback, interior side yard setback* and the *rear yard setback* shall be 20 metres.

7.3 Special Exceptions AE Zone

By-Law No.	Zone Code	Description
Not Available	AE-1	Notwithstanding any provisions of this By-Law to the contrary, within any area <i>zoned</i> AE-1 on Schedule "A" hereto, the permitted <i>uses</i> shall be limited to a <i>contractor's yard</i> for an excavation and bulldozing business and a <i>transport/truck terminal</i> . All other requirements of the By-Law shall apply.
121-02	AE-2	Notwithstanding any provisions of this By-Law to the contrary, within any area <i>zoned</i> AE-2 on Schedule "A" hereto, the permitted <i>uses</i> shall be limited to an <i>automobile repair garage</i> . All other requirements of the By-Law shall apply.

SECTION 7: AGRICULTURAL EMPLOYMENT (AE) ZONE

By-Law No.	Zone Code	Description
Not Available	AE-3	<p>Notwithstanding any provisions of this By-Law to the contrary, within any area <i>zoned</i> AE-3 on Schedule "A" hereto, the permitted <i>uses</i> shall be limited to:</p> <ul style="list-style-type: none"> a) an <i>automobile repair garage</i>; b) a saw mill operation; c) an <i>auto body shop</i>; d) a machine and welding shop; and e) a carpentry shop. <p>All other requirements of the By-Law shall apply.</p>
160-10	AE-4	<p>Notwithstanding any provisions of this By-Law to the contrary, within any area <i>zoned</i> AE-4 on Schedule "A" hereto, the permitted <i>uses</i> shall be limited to:</p> <ul style="list-style-type: none"> a) an agricultural machinery sales outlet and repair establishment; b) a welding and machine repair shop; c) a dog <i>kennel</i> for up to 40 dogs and employing not more than five (5) hired staff; and d) a <i>single detached dwelling accessory</i> to a permitted <i>use</i>. <p>All other requirements of the By-Law shall apply.</p>
Not Available	AE-5	<p>Notwithstanding any provisions of this By-Law to the contrary, within any area <i>zoned</i> AE-5 on Schedule "A" hereto, the permitted <i>uses</i> shall be limited to:</p> <ul style="list-style-type: none"> a) a <i>feed mill</i>; b) a grain elevator and drying facilities; c) an <i>open storage use accessory</i> to the <i>feed mill</i> or grain elevator; d) a <i>retail store, wholesale establishment or business office accessory</i> to the permitted <i>uses</i>; and e) <i>accessory uses, buildings and structures accessory</i> to the foregoing <i>uses</i>. <p>All other requirements of the By-Law shall apply.</p>

SECTION 7: AGRICULTURAL EMPLOYMENT (AE) ZONE

By-Law No.	Zone Code	Description
Not Available	AE-6	<p>Notwithstanding any provisions of this By-Law to the contrary, within any area <i>zoned</i> AE-6 on Schedule "A" hereto, the permitted <i>uses</i> shall be limited to:</p> <ul style="list-style-type: none"> a) an <i>agricultural service and supply establishment</i>; b) a farm implement dealer; c) an <i>automobile service station</i>; d) a <i>farm produce outlet</i>; e) a <i>parking lot</i> associated with the <i>use</i>; and f) a machinery repair and welding shop. <p>Furthermore, the minimum northerly <i>interior side yard</i> shall be 0.5 metres and a residential <i>use</i> shall not be permitted.</p> <p>All other requirements of the By-Law shall apply.</p>
Not Available	AE-7	<p>Notwithstanding any provisions of this By-Law to the contrary, within any area <i>zoned</i> AE-7 on Schedule "A" hereto, the permitted <i>uses</i> shall be limited to:</p> <ul style="list-style-type: none"> a) the sales and service of motorcycles and <i>recreational vehicles</i> and other <i>vehicles</i>; b) A minimum <i>interior side yard</i> of 30 metres shall be required for the display and storage for the sale and service of <i>vehicles</i>. <p>All other requirements of the By-Law shall apply.</p>
255-07	AE-8	<p>Notwithstanding any provisions of this By-Law to the contrary, within any area <i>zoned</i> AE-8 on Schedule "A" hereto, the permitted <i>uses</i> shall be limited to a <i>service shop</i>, a single <i>dwelling unit</i>, and <i>accessory uses, buildings and structures</i>. All other requirements of the By-Law shall apply.</p>
Not Available	AE-9	<p>Notwithstanding any provisions of this By-Law to the contrary, within any area <i>zoned</i> AE-9 on Schedule "A" hereto, the permitted <i>uses</i> shall be limited to:</p> <ul style="list-style-type: none"> a) an <i>automotive use</i>, b) <i>agricultural equipment use</i>; c) a single <i>dwelling unit</i>, and d) <i>Accessory uses, buildings and structures</i>. <p>All other requirements of the By-Law shall apply.</p>

SECTION 7: AGRICULTURAL EMPLOYMENT (AE) ZONE

By-Law No.	Zone Code	Description
Not Available	AE-10	<p>Notwithstanding any provisions of this By-Law to the contrary, within any area <i>zoned</i> AE-10 on Schedule "A" hereto, the permitted <i>uses</i> shall be limited to:</p> <ul style="list-style-type: none"> a) a <i>convenience store</i>; b) the sale of fresh fruit and vegetables; c) a single <i>dwelling unit</i>; and d) <i>accessory uses, buildings and structures</i>. <p>All other requirements of the By-Law shall apply.</p>
Not Available	AE-11	<p>Notwithstanding any provisions of this By-Law to the contrary, within any area <i>zoned</i> AE-11 on Schedule 'A' hereto, the permitted <i>uses</i> shall be limited to a <i>contractor's yard</i> and/or a construction business and <i>accessory uses, buildings and structures</i>. All other requirements of the By-Law shall apply.</p>
109-04	AE-12	<p>Notwithstanding any provision of this By-Law to the contrary, within any area <i>zoned</i> AE-12 on Schedule "A" hereto, the permitted <i>uses</i> shall be limited to:</p> <ul style="list-style-type: none"> a) a meat market, b) a <i>single detached dwelling</i> c) an <i>agricultural equipment sales and service establishment</i> d) a <i>bulk sales establishment</i> primarily related to farm including fuels, feed and implements e) a <i>contractor's yard</i> f) a farm machinery sales outlet g) a <i>greenhouse</i> h) a <i>nursery and garden centre</i> i) a <i>retail store</i> related to fresh farm produce, landscaping and/or gardening supplies, antiques, gift shop, tourist shop j) a tradesman shop k) <i>uses accessory</i> to the foregoing. <p>Further, the minimum left <i>interior side yard</i> shall be 4.2 metres. All other requirements of the By-Law shall apply.</p>
Not Available	AE-13	<p>Notwithstanding any provisions of this By-Law to the contrary, within any area <i>zoned</i> AE-13 on Schedule "A" hereto, the permitted <i>uses</i> shall be limited to:</p> <ul style="list-style-type: none"> a) a harness shop including the sale and repair of saddles, harnesses and related goods; b) a <i>single detached dwelling</i>; c) an <i>agricultural use</i>; and d) <i>accessory uses, buildings and structures</i>. <p>All other requirements of the By-Law shall apply.</p>

SECTION 7: AGRICULTURAL EMPLOYMENT (AE) ZONE

By-Law No.	Zone Code	Description
Not Available	AE-14	Notwithstanding any provisions of this By-Law to the contrary, within any area zoned AE-14 on Schedule "A" hereto, the permitted <i>uses</i> shall be limited to a television and radio sales and service business, a <i>single detached dwelling</i> and <i>accessory uses, buildings and structures</i> . All other requirements of the By-Law shall apply.
Not Available	AE-15	Notwithstanding any provisions of this By-Law to the contrary, within any area zoned AE-15 on Schedule "A" hereto, the permitted <i>uses</i> shall be limited to: <ul style="list-style-type: none"> a) an <i>abattoir</i> and meat market; b) a <i>single dwelling unit</i>; and c) <i>accessory uses, buildings and structures</i>. All other requirements of the By-Law shall apply.
Not Available	AE-16	Notwithstanding any provision of this By-law to the contrary, within any area zoned AE-16 on Schedule "A" hereto, the permitted <i>uses</i> shall be limited to a craft and gift shop, <i>retail store, warehouse, public self-storage</i> , garden centre and one <i>single detached dwelling</i> . The following <i>development</i> standards shall apply: <ul style="list-style-type: none"> a) <i>Interior Side Yard</i> 3.0 metres b) <i>Lot Coverage</i> (maximum): <ul style="list-style-type: none"> i. Commercial: 4,090 square metres ii. Residential: 300 square metres c) <i>Landscaped Open Space</i> (minimum): 20 percent d) <i>Minimum loading spaces</i>: 1 e) <i>Minimum parking spaces</i>: 91 (including 4 accessible <i>parking spaces</i>) All other requirements of the By-Law shall apply.
Not Available	AE-17	Notwithstanding any provisions of this By-Law to the contrary, within any area zoned AE-17 on Schedule "A" hereto, the permitted <i>uses</i> shall be limited to: <ul style="list-style-type: none"> a) a <i>transport/truck terminal</i>; b) the manufacturing of cleaning products; c) a <i>bulk sales establishment</i>; d) <i>boat building</i>; e) a <i>contractor's yard</i>; f) a <i>single detached dwelling unit</i>; and g) <i>accessory uses, buildings and structures</i>. h) Furthermore, the maximum <i>lot coverage</i> shall be limited to a total <i>building area</i> of 1,850 square metres. All other requirements of the By-Law shall apply.

SECTION 7: AGRICULTURAL EMPLOYMENT (AE) ZONE

By-Law No.	Zone Code	Description
Not Available	AE-18	<p>Notwithstanding any provisions of this By-Law to the contrary, within any area <i>zoned</i> AE-18 on Schedule "A" hereto, in addition to the <i>uses</i> permitted in the Agricultural Employment (AE) Zone, the following shall also be permitted:</p> <ul style="list-style-type: none"> a) sale of home furnishings and home decorations; b) a <i>business office</i> having a maximum <i>gross floor area</i> of 465 square metres; c) a <i>retail store</i> having a maximum <i>gross floor area</i> of 2230 square metres; d) a <i>public self-storage warehouse</i> having a maximum <i>gross floor area</i> of 3345 square metres where portions of a <i>building</i> are leased by the public for the purposes of storing goods and materials; and e) <i>accessory uses, buildings and structures.</i> <p>All other requirements of the By-Law shall apply.</p>
Not Available	AE-19	<p>Notwithstanding any provisions of this By-Law to the contrary, within any area <i>zoned</i> AE-19 on Schedule "A" hereto, the permitted <i>uses</i> shall be limited to:</p> <ul style="list-style-type: none"> a) a grading station for farm produce; b) a <i>grain elevator</i> or other storage facility for farm produce; c) a <i>nursery and garden centre</i>; d) a <i>retail store</i> engaged in the sale of farm produce or landscaping and garden supplies; e) a <i>service shop</i>; f) a <i>transport/truck terminal</i>; g) an <i>automobile sales or rental establishment</i> engaged only in the sales and service of farm implements and related equipment and; h) an <i>automobile repair garage accessory</i> to a permitted use. <p>All other requirements of the By-Law shall apply.</p>
83-07	AE-20	<p>Notwithstanding any provision of this By-Law to the contrary, within any area <i>zoned</i> AE-20 on Schedule "A" hereto, a non-effluent producing industrial use shall also be permitted. All other requirements of the By-Law shall apply.</p>

SECTION 7: AGRICULTURAL EMPLOYMENT (AE) ZONE

By-Law No.	Zone Code	Description
121-02	AE-21	Notwithstanding any provisions of this By-Law to the contrary, within any area zoned AE-21 on Schedule "A" hereto, in addition to the uses permitted in the Agricultural Employment (AE) Zone, two <i>dwelling units</i> shall also be permitted. All other requirements of the By-Law shall apply.
77-08	AE-22	Notwithstanding anything in this By-Law to the contrary, within any area zoned AE-22 on Schedule "A" hereto, the permitted uses shall be limited to: <ul style="list-style-type: none"> a) a <i>feed mill</i>; b) a <i>grain elevator and drying facilities</i>; c) an <i>open storage use accessory</i> to the <i>feed mill</i> or grain elevator; d) a <i>retail store, wholesale establishment or business office accessory</i> to the permitted uses; e) a truck repair business, excluding an <i>auto body shop</i>, located within <i>buildings existing</i> as of March 1, 2008 and f) <i>accessory uses, buildings and structures accessory</i> to the foregoing uses. <p>All other requirements of the By-Law shall apply.</p>
157-10	AE-23	Notwithstanding any provisions of this By-Law to the contrary, within any area zoned AE-23 on Schedule "A" hereto, the uses permitted shall be limited to; <ul style="list-style-type: none"> a) a <i>single detached dwelling</i>; b) <i>crafts shop</i>; c) merchandise service shop; d) <i>personal service establishment</i>; e) <i>service shop</i>; and f) <i>retail store or wholesale establishment or business accessory</i> to permitted use. <p>All other requirements of the By-Law shall apply.</p>

SECTION 7: AGRICULTURAL EMPLOYMENT (AE) ZONE

By-Law No.	Zone Code	Description
157-10	AE-24	<p>Notwithstanding any provisions of this By-Law to the contrary, within any area zoned AE-24 on Schedule "A" hereto, the uses permitted shall be limited to:</p> <ul style="list-style-type: none"> a) <i>agricultural equipment sales and service establishment;</i> b) <i>bulk sales establishment</i> primarily related to farm including fuels, feed, and implements; c) <i>contractor's yard;</i> d) <i>convenience store;</i> e) <i>single detached dwelling;</i> f) <i>farm machinery sales outlet and repair establishment;</i> g) <i>furniture, automotive supplies, hardware, or crafts shop;</i> h) <i>greenhouse;</i> i) <i>nursery and garden centre;</i> j) <i>open storage;</i> k) <i>parking lot</i> associated with the permitted use; l) <i>personal service establishment;</i> m) <i>place of worship;</i> n) <i>retail store</i> related to fresh farm produce, landscaping and/or gardening supplies, antiques, gift shop, tourist shop; o) <i>sawmill;</i> p) <i>service shop;</i> q) <i>an automobile repair garage;</i> r) <i>automobile sales or rental establishment;</i> s) <i>veterinary clinic;</i> t) <i>video rental establishment;</i> u) <i>warehouse;</i> v) <i>wholesale establishment</i> or business accessory to permitted use. <p>All other requirements of the By-Law shall apply.</p>
112-04	AE-25	<p>Notwithstanding any provisions of this By-Law to the contrary, within any area zoned AE-25 on Schedule "A" hereto, the permitted uses shall be limited to an <i>agricultural equipment sales and service establishment</i> and a <i>single detached dwelling</i>.</p> <p>All other requirements of the By-Law shall apply.</p>

SECTION 7: AGRICULTURAL EMPLOYMENT (AE) ZONE

By-Law No.	Zone Code	Description
Not Available	AE-26	<p>Notwithstanding any provisions of this By-Law to the contrary, within any area <i>zoned</i> AE-26 on Schedule "A" hereto, the permitted <i>uses</i> shall be limited to:</p> <ul style="list-style-type: none"> a) a <i>contractor's yard</i>; b) a concrete fabricating business; c) an outside storage area; d) a <i>parking area</i> associated with the permitted <i>use</i>; e) a <i>transport/truck terminal</i>; f) one <i>building</i> for the aforementioned <i>uses</i> having a maximum <i>gross floor area</i> of 240 square metres; g) a <i>single detached dwelling accessory</i> to the permitted <i>use</i>; and h) a <i>retail store, wholesale establishment</i> or <i>business office accessory</i> to a permitted <i>use</i>. <p>All other requirements of the By-Law shall apply.</p>
45-11	AE-27	<p>Notwithstanding any provisions of this By-Law to the contrary, within any area <i>zoned</i> AE-27 on Schedule "A" hereto, the permitted <i>uses</i> shall be limited to:</p> <ul style="list-style-type: none"> a) a grain elevator, b) a <i>parking lot</i> associated with the <i>use</i>, c) a <i>warehouse</i> associated to the <i>main use</i>, d) a <i>feed mill</i>, e) a weigh scale, f) a <i>transport/truck terminal</i>, g) a <i>retail store</i> or <i>business office accessory</i> to the permitted <i>use</i>. <p>All other requirements of the By-Law shall apply.</p>
45-11	AE-28	<p>Notwithstanding any provisions of this By-Law to the contrary, within any area <i>zoned</i> AE-28 on Schedule "A" hereto, the permitted <i>uses</i> shall be limited to a <i>parking lot, a retail store</i> or <i>business office accessory</i> to the permitted <i>use</i> in AE-28 Zone.</p> <p>All other requirements of the By-Law shall apply.</p>

SECTION 7: AGRICULTURAL EMPLOYMENT (AE) ZONE

By-Law No.	Zone Code	Description
207-03, 5-09, 50-15, 157-15, 24-16	AE-29	<p>Notwithstanding any provision of this By-Law to the contrary, within any area <i>zoned</i> AE-29 on Schedule 'A' attached hereto, in addition to the <i>uses</i> permitted within the Agricultural Employment (AE) <i>Zone</i> the following <i>uses</i> shall also be permitted:</p> <ul style="list-style-type: none"> a) manufacturing and fabricating of metal and concrete products; b) <i>warehouse</i>; c) <i>open storage</i>; d) <i>wholesale establishment</i>; e) <i>support office</i>. <p>The following <i>development</i> standards shall apply:</p> <ul style="list-style-type: none"> a) <i>Front Yard</i> (Minimum): 260.0 metres to Muir Road South. b) The minimum distance separation (MDS) setback from the livestock operation on 813839 Muir Road South shall be 353 metres. c) No <i>buildings/structures</i>, parking or loading, storage or display, shall be permitted within the required <i>front yard</i>, except a <i>building/structure</i> used as an office with associated parking <i>accessory</i> to the permitted <i>use</i>, shall be a minimum of 75.0metres from the <i>front lot line</i> (Muir Road South) and a minimum of 15.0metres from the <i>interior</i> (north) <i>lot line</i>. d) <i>Interior Side Yard</i> (Minimum): 28.0 metres to the north <i>lot line</i> and the minimum <i>interior side yard setback</i> to the south <i>lot line</i> shall be 15.0 metres. e) <i>Rear Yard</i> (Minimum): 55.0 metres to the east <i>lot line</i>. f) <i>Lot Coverage</i> (Maximum): 10% g) <i>Building Height</i> (Maximum): 30.0 metres <p>All other requirements of By-law shall apply.</p>
Not Available	AE-30	<p>Notwithstanding any provisions of this By-Law to the contrary, within any area <i>zoned</i> AE-30 on Schedule 'A' hereto, the permitted <i>uses</i> shall be limited to a <i>greenhouse</i>, a garden centre and a <i>farm produce outlet</i>. All other requirements of the By-Law shall apply.</p>
Not Available	AE-31	<p>Notwithstanding any provisions of this By-Law to the contrary, within any area <i>zoned</i> AE-31 on Schedule 'A' hereto, the permitted <i>uses</i> shall be limited to a <i>service shop</i>, a <i>contractors yard</i>, a <i>single detached dwelling</i> and <i>accessory uses, buildings and structures</i>. An <i>existing</i> excavation business shall also be permitted. All other requirements of the By-Law shall apply.</p>

SECTION 7: AGRICULTURAL EMPLOYMENT (AE) ZONE

By-Law No.	Zone Code	Description
Not Available	AE-32	Notwithstanding any provisions of this By-Law to the contrary, within any area <i>zoned</i> AE-32 on Schedule "A" hereto, in addition to the <i>uses</i> permitted in the Agricultural Employment (AE) Zone, a processing plant shall also be permitted. All other requirements of the By-Law shall apply.
140-03	AE-33	Notwithstanding any provisions of this By-Law to the contrary, within any area <i>zoned</i> AE-33 on Schedule "A" hereto, in addition to the <i>uses</i> permitted in the Agricultural Employment (AE) Zone, <i>uses</i> listed in Automotive Commercial (C6) Zone shall also be permitted in accordance with the C6 Zone provisions. All other requirements of the By-Law shall apply.
Not Available	AE-34	Notwithstanding any provisions of this By-Law to the contrary, within any area <i>zoned</i> AE-34 on Schedule "A" hereto, the permitted <i>uses</i> shall be limited to <i>sawmill</i> . All other requirements of the By-Law shall apply.
Not Available	AE-35	Notwithstanding any provisions of this By-Law to the contrary, within any area <i>zoned</i> AE-35 on Schedule "A" hereto, the permitted <i>uses</i> shall be limited to a <i>contractor's yard</i> for a carpentry and wood construction business and on-site construction of log <i>buildings</i> and <i>structures</i> and related outdoor storage <i>uses</i> thereto. All other requirements of the By-Law shall apply.
Not Available	AE-36	Notwithstanding any provisions of this By-Law to the contrary, within any area <i>zoned</i> AE-36 on Schedule "A" hereto, the permitted <i>uses</i> shall be limited to a manufacturing plant for marble products. All other requirements of the By-Law shall apply.
Not Available	AE-37	Notwithstanding any provisions of this By-Law to the contrary, within any area <i>zoned</i> AE-37 on Schedule "A" hereto, the permitted <i>uses</i> shall be limited to a machine shop and a tool and die manufacturing plant. All other requirements of the By-Law shall apply.
30-82	AE-38	Notwithstanding any provisions of this By-Law to the contrary, within any area <i>zoned</i> AE-38 on Schedule "A" hereto, the permitted <i>uses</i> shall be limited to a bus <i>transport terminal</i> and <i>buildings</i> and <i>structures accessory</i> thereto. All other requirements of the By-Law shall apply.

SECTION 7: AGRICULTURAL EMPLOYMENT (AE) ZONE

By-Law No.	Zone Code	Description
Not Available	AE-39	Notwithstanding any provisions of this By-Law to the contrary, within any area <i>zoned</i> AE-39 on Schedule "A" hereto, the permitted <i>uses</i> shall be limited to an <i>automobile service station</i> , a <i>salvage yard</i> , a <i>retail store</i> , a <i>wholesale establishment</i> or a <i>business office accessory</i> to a permitted <i>use</i> and a <i>single detached dwelling accessory</i> to the permitted <i>uses</i> . All other requirements of the By-Law shall apply.
Not Available	AE-40	Notwithstanding any provisions of this By-Law to the contrary, within any area <i>zoned</i> AE-40 on Schedule "A" hereto, the permitted <i>uses</i> shall be limited to a machine shop and an <i>accessory residential dwelling unit</i> . All other requirements of the By-Law shall apply.
Not Available	AE-41	Notwithstanding any provisions of this By-Law to the contrary, within any area <i>zoned</i> AE-41 on Schedule "A" hereto, the permitted <i>uses</i> shall be limited to a <i>nursery and garden centre</i> , a <i>farm produce outlet</i> and a <i>single detached dwelling</i> which is <i>accessory</i> to a permitted <i>use</i> . All other requirements of the By-Law shall apply.
Not Available	AE-42	Notwithstanding any provisions of this By-Law to the contrary, within any area <i>zoned</i> AE-42 on Schedule "A" hereto, the permitted <i>uses</i> shall be limited to: <ul style="list-style-type: none"> a) a business involving the retailing and servicing of <i>boats, recreational vehicles</i> and leisure equipment; b) a farm implement dealer; c) a <i>farm produce outlet</i>; d) an <i>automobile sales or rental establishment</i>; e) an <i>accessory parking lot</i>; f) a <i>single detached dwelling accessory</i> to a permitted <i>use</i>; and g) a consulting office and business related to the servicing of regulating equipment. All other requirements of the By-Law shall apply.
Not Available	AE-43	Notwithstanding any provisions of this By-Law to the contrary, within any area <i>zoned</i> AE-43 on Schedule "A" hereto, the permitted <i>uses</i> shall be limited to an <i>automobile repair garage</i> ; the sale and service of recreational equipment; and <i>accessory uses, buildings and structures</i> . All other requirements of the By-Law shall apply.

SECTION 7: AGRICULTURAL EMPLOYMENT (AE) ZONE

By-Law No.	Zone Code	Description
149-06	AE-44	Notwithstanding any provision in this By-Law to the contrary, within any area <i>zoned</i> AE-44 on Schedule "A" hereto, the permitted <i>uses</i> shall be limited to a <i>nursery and garden centre</i> and a <i>farm produce outlet</i> . Furthermore, a <i>dwelling</i> shall not be permitted. All other requirements of the By-Law shall apply.
Not Available	AE-45	Notwithstanding any provisions of this By-Law to the contrary, within any area <i>zoned</i> AE-45 on Schedule "A" hereto, the permitted <i>uses</i> shall be limited to a <i>building supply outlet</i> . All other requirements of the By-Law shall apply.

SECTION 8: URBAN RESIDENTIAL (R) ZONES

8.1 Uses Permitted

No person shall within any Urban Residential (R) Zones, use any lot or erect, alter or use any building or structure for any purpose except for one or more of the following uses, as identified by a “dot”.

The Urban Residential Zones established by this By-Law are as follows:

R1	Residential Singles
R2	Residential Singles and Semis
RM1	Residential Multiple Low Density
RM2	Residential Multiple Medium Density
RM3	Residential Multiple High Density

Table 8.1: Uses Permitted

List of uses	Zones				
	R1	R2	RM1	RM2	RM3
<i>Dwelling, Apartment</i>					•
<i>Dwelling, Duplex</i>	• ¹	• ¹	•		
<i>Dwelling, Fourplex</i>				•	•
<i>Dwelling, Rowhouse</i>			•	•	•
<i>Dwelling, Semi-Detached</i>		•	•		
<i>Dwelling, Single Detached</i>	•	•	•		
<i>Dwelling, Stacked Townhouse</i>			•	•	•
<i>Dwelling, Street Fronting Rowhouse</i>			•	•	•
<i>Dwelling, Triplex</i>			•	•	•
<i>Group Home</i>	•	•	•		
<i>Lodging House</i>			•	•	•

¹ Existing only

SECTION 8: URBAN RESIDENTIAL (R) ZONES

8.2 Zone Requirements

No person shall within any Urban Residential (R) Zones, use any lot or erect, alter or use any building or structure except in accordance with the provisions as set out in Tables 8.2 and 8.3 below:

Table 8.2: Zone Provisions

Provisions	Single Detached Dwelling		Semi Detached Dwelling	Semi Detached Dwelling Unit	Duplex Dwelling
	R1 and RM1	R2			
Zones	R1 and RM1	R2			
Lot Area , Minimum (sq. m)	360	450	550	250	550
Lot Frontage , Minimum (metres)	11	15	18	9.0	18
Street Setback , to the attached garage, Minimum (metres)	6.0	6.0	6.0	6.0	6.0
Street Setback , to habitable portion of the dwelling, Minimum (metres)*	4.5	4.5	4.5	4.5	4.5
Interior Side Yard Setback , Minimum (metres)	1.2	1.2	1.2	1.2	1.2
Rear Yard Setback , Minimum (metres)	6.0	6.0	6.0	6.0	6.0
Lot Coverage , Maximum**	40%	40%	40%	40%	40%
Landscaped Open Space , Minimum	30%	30%	30%	30%	30%
Building Height , Maximum (metres)	10.5	10.5	10.5	10.5	10.5

* provided the minimum width of the driveway shall be 5.6 metres.

** Maximum Lot Coverage of 40% shall apply to dwelling units. Maximum overall lot coverage of 45% shall be permitted. The additional 5% shall only be used for accessory buildings or structures.

SECTION 8: URBAN RESIDENTIAL (R) ZONES

Table 8.3: Zone Provisions for multiple dwellings in RM1, RM2 and RM3 Zones

Provisions*	Triplex, Fourplex, Lodging House, Stacked Townhouse Street Rowhouse/ Rowhouse*	Apartment Dwelling
Lot Area , Minimum (sq. m)	185 sq. m per unit	1800
Lot Frontage , Minimum (metres)	20.0**	30.0
Street Setback , Minimum (metres)	6.0	7.5
Interior Side Yard Setback , Minimum (metres)	3.0	7.5
Rear Yard Setback , Minimum (metres)	6.0	7.5
Lot Coverage , Maximum	40%	40%
Landscaped Open Space , Minimum	30%	30%
Building Height , Maximum (metres)	12.0	20.0
Separation Distance between buildings on same lot , Minimum (metres)	3.0	3.0

* For the purposes of this By-Law, the parcels/units in the Plan of Condominium shall be deemed as *lots*.

** Minimum *Lot Frontage* for *Rowhouse Dwellings* and *Street Fronting Rowhouse Dwellings* shall be 9.0 metres.

8.3 Special Exceptions R1 Zone

By-Law No.	Zone Code	Description
126-04, 239-04, 94-06, 6-02, 175-01, 82-15, 127-09, 260-10	R1-1	Notwithstanding any provisions of this By-Law to the contrary, within any area zoned R1-1 on Schedule "A" hereto, the minimum <i>exterior side yard</i> shall be 4.5 metres. All other requirements of the By-Law shall apply.

SECTION 8: URBAN RESIDENTIAL (R) ZONES

By-Law No.	Zone Code	Description
78-05, 146-06, 23-12, 54-13	R1-2	Notwithstanding any provisions of this By-Law to the contrary, within any area <i>zoned</i> R1-2 on Schedule “A” hereto, the minimum <i>exterior side yard</i> shall be 3.0 metres. All other requirements of the By-Law shall apply.
127-09, 260-10	R1-3	Notwithstanding any provision of this By-Law to the contrary, within any area <i>zoned</i> R1-3 on Schedule “A” hereto, the minimum <i>exterior side yard</i> shall be 4.5 metres and no part of a <i>dwelling</i> shall be less than 15.4 metres to the south <i>lot line</i> . All other requirements of the By-Law shall apply.
93-12, 90-14	R1-4	<p>Notwithstanding any provision of this By-Law to the contrary, within any area <i>zoned</i> R1-4 on Schedule “A” hereto, <i>development</i> shall be permitted subject to the following regulations:</p> <ul style="list-style-type: none"> i) the maximum number of <i>dwelling units</i> be 23; ii) a <i>lot</i> is considered to be the land area which constitutes a unit of a <i>condominium</i> corporation; iii) a <i>lot</i> does not require frontage on a <i>public street</i>; iv) <i>lot area</i>, <i>lot frontage</i> and <i>yards</i> shall be determined as if the common element road were a <i>public street</i>; v) the minimum <i>lot frontage</i> shall be 14.0 metres; vi) for the purpose of this <i>Zone</i> “adjacent” means abutting or separated only by a portion of the common element vii) a <i>lot</i> with a <i>rear yard</i> adjacent to Willow Street shall have a minimum <i>lot area</i> of 400 square metres, a <i>lot</i> with a <i>rear yard</i> not adjacent to Willow Street shall have a minimum <i>lot area</i> of 300 square metres; viii) a minimum <i>interior side yard</i> adjacent to Willow Street shall be 0.0 metres; ix) a minimum <i>rear yard</i> abutting Willow Street shall be 3.0 metres, and 0.0 metres for any other <i>rear yard</i>; x) the minimum <i>front yard</i> shall be 4.5m except to a <i>garage</i> which shall be 5.5m; and xi) a <i>lot</i> with a <i>rear yard</i> adjacent to Willow Street shall have maximum <i>lot coverage</i> of 45%; any <i>lot</i> with a <i>rear yard</i> not adjacent to Willow Street shall have maximum <i>lot coverage</i> of 65%. <p>All other requirements of the By-Law shall apply.</p>

SECTION 8: URBAN RESIDENTIAL (R) ZONES

By-Law No.	Zone Code	Description																		
158-13, 24-15	R1-5	<p>Notwithstanding any provision of this By-Law to the contrary, within any area <i>zoned</i> R1-5 on Schedule “A” hereto, the following <i>development</i> standards shall apply:</p> <ul style="list-style-type: none"> a) Minimum <i>exterior side yard</i> 4.5 metres b) Maximum <i>lot coverage</i> 45% <p>All other requirements of the By-Law shall apply.</p>																		
114-14	R1-6	<p>Notwithstanding any provision of this By-Law to the contrary, within any area <i>zoned</i> R1-6 on Schedule “A” hereto, the following <i>lot area</i> and <i>lot coverage</i>’s shall apply:</p> <table style="width: 100%; border-collapse: collapse;"> <thead> <tr> <th style="text-align: left;">Municipal Address</th> <th style="text-align: left;"><i>Lot Area</i></th> <th style="text-align: left;"><i>Lot Coverage</i></th> </tr> </thead> <tbody> <tr> <td>19 Irongate Drive (Lot 5)</td> <td>460m²</td> <td>45%</td> </tr> <tr> <td>21 Irongate Drive (Lot 4)</td> <td>416m²</td> <td>--</td> </tr> <tr> <td>23 Irongate Drive (Lot 3)</td> <td>416m²</td> <td>--</td> </tr> <tr> <td>25 Irongate Drive (Lot 2)</td> <td>--</td> <td>45%</td> </tr> <tr> <td>27 Irongate Drive (Lot 1)</td> <td>--</td> <td>45%</td> </tr> </tbody> </table> <p>All other requirements of the By-Law shall apply.</p>	Municipal Address	<i>Lot Area</i>	<i>Lot Coverage</i>	19 Irongate Drive (Lot 5)	460m ²	45%	21 Irongate Drive (Lot 4)	416m ²	--	23 Irongate Drive (Lot 3)	416m ²	--	25 Irongate Drive (Lot 2)	--	45%	27 Irongate Drive (Lot 1)	--	45%
Municipal Address	<i>Lot Area</i>	<i>Lot Coverage</i>																		
19 Irongate Drive (Lot 5)	460m ²	45%																		
21 Irongate Drive (Lot 4)	416m ²	--																		
23 Irongate Drive (Lot 3)	416m ²	--																		
25 Irongate Drive (Lot 2)	--	45%																		
27 Irongate Drive (Lot 1)	--	45%																		
Not Available	R1-7	<p>Notwithstanding any provisions of this By-Law to the contrary, within any area <i>zoned</i> R1-7 on Schedule “A” hereto, in addition to the <i>Zone</i> regulations for single <i>detached dwelling units</i>, a monolithic <i>basement</i> and gas collection and venting system shall be required. All other requirements of the By-Law shall apply.</p>																		
Not Available	R1-8	<p>Notwithstanding any provisions of this By-Law to the contrary, within any area <i>zoned</i> R1-8 on Schedule “A” hereto, in addition to the <i>uses</i> permitted in the Residential Singles (R1) <i>Zone</i>, a <i>day care</i> shall also be permitted. All other requirements of the By-Law shall apply.</p>																		
Not Available	R1-9	<p>Notwithstanding any provisions of this By-Law to the contrary, within any area <i>zoned</i> R1-9 on Schedule “A” hereto, the following special provisions shall apply:</p> <ul style="list-style-type: none"> a) Permitted <i>Uses</i>: <ul style="list-style-type: none"> i) A maximum of 450 <i>dwelling units</i> in the form of <i>single detached dwellings</i>, <i>semi-detached dwellings</i>, and/or <i>rowhouse dwellings</i> as well as <i>accessory buildings</i>. ii) No more than 135 <i>rowhouse dwelling units</i> are permitted. iii) Any <i>use</i> permitted in the OS2-2 <i>Zone</i>. b) Requirements: <ul style="list-style-type: none"> i) The minimum <i>setback</i> from abutting lands <i>zoned</i> R1 is 30 metres, with the exception of the easterly boundary, where this <i>setback</i> will not apply if abutting lands are held in common ownership. The minimum <i>setback</i> from all other <i>lot lines</i> shall be 9.1 metres. ii) The maximum number of <i>dwelling units per building</i> shall be 8 units. iii) The maximum <i>building height</i> shall be 10.7 metres. <p>All other requirements of the By-Law shall apply.</p>																		

SECTION 8: URBAN RESIDENTIAL (R) ZONES

By-Law No.	Zone Code	Description
95-05	R1-10	Notwithstanding any provisions of this By-Law to the contrary, within any area <i>zoned</i> R1-10 on Schedule "A" hereto, in addition to the <i>uses</i> permitted in the Residential Singles (R1) <i>Zone</i> , six executive suites shall also be permitted at 141 Golf Links Road and five executive suites and an office shall be permitted at 149 Golf Links Road, said executive suites and offices being <i>accessory</i> to the Paris Grand Golf Course operations. All other requirements of the By-Law shall apply.
Not Available	R1-11	Notwithstanding any provisions of this By-Law to the contrary, within any area <i>zoned</i> R1-11 on Schedule "A" hereto, in addition to the <i>uses</i> permitted in the Residential Singles (R1) <i>Zone</i> , cartage, express or <i>truck terminal</i> shall also be permitted. All other requirements of the By-Law shall apply.
Not Available	R1-12	Notwithstanding any provisions of this By-Law to the contrary, within any area <i>zoned</i> R1-12 on Schedule "A" hereto, in addition to the <i>uses</i> permitted in the Residential Singles (R1) <i>Zone</i> , an <i>automobile sales and rental establishment</i> shall also be permitted. Furthermore, the <i>gross floor area</i> of the <i>building</i> used for such <i>use</i> shall not exceed 72 square metres, no outside storage of <i>vehicles</i> or parts shall be permitted. All other requirements of the By-Law shall apply.
Not Available	R1-13	Notwithstanding any provisions of this By-Law to the contrary, within any area <i>zoned</i> R1-13 on Schedule "A" hereto, in addition to the <i>uses</i> permitted in the Residential Singles (R1) <i>Zone</i> , a <i>service shop</i> shall also be permitted. The <i>gross floor area</i> of the <i>service shop</i> shall not exceed 89 square metres and no outside storage shall be permitted. All other requirements of the By-Law shall apply.
15-12, 170-12	R1-14	Notwithstanding any provision of this By-Law to the contrary, within any area <i>zoned</i> R1-14 on Schedule "A" hereto, the total <i>lot coverage</i> of all <i>accessory buildings</i> shall not be greater than 319 square metres, provided that any <i>accessory building</i> erected in a <i>front yard</i> shall be no larger than 50 square metres, have an overall <i>height</i> not greater than 5.0 metres, and further, no <i>accessory building</i> in a <i>rear yard</i> shall exceed an overall <i>height</i> of 7.6 metres. All other requirements of the By-Law shall apply.

SECTION 8: URBAN RESIDENTIAL (R) ZONES

By-Law No.	Zone Code	Description
59-09, 39-14, 110-15	R1-15	<p>Notwithstanding any provisions of this By-Law to the contrary, within any area zoned R1-15 on Schedule "A" hereto, the following <i>development</i> standards shall apply:</p> <ul style="list-style-type: none"> a) <i>Lot Area</i> (Minimum) 460m² b) <i>Lot Frontage</i> (Minimum) 15.0m c) <i>Front Yard</i> (Minimum) 4.5m provided no part of the <i>structure</i> used as a <i>carport</i> or <i>garage</i> is closer than 5.5m to the <i>front lot line</i> d) <i>Interior Side Yard</i> (Minimum) 1.0m provided that on a <i>lot</i> where there is not attached <i>carport</i> or attached <i>garage</i> the minimum <i>interior side yard</i> width shall be 3.0m on one side and 1.0m on the other side e) <i>Exterior Side Yard</i> (Minimum) 3.0m f) <i>Rear Yard</i> (Minimum) 6.0m g) <i>Lot Coverage</i> (Maximum) 45% h) <i>Lot Coverage for a Dwelling</i> (Maximum) 40% <p>All other requirements of the By-Law shall apply.</p>
59-09, 39-14, 110-15	R1-16	<p>Notwithstanding any provisions of this By-Law to the contrary, within any area zoned R1-16 on Schedule "A" hereto, the following <i>development</i> standards shall apply:</p> <ul style="list-style-type: none"> a) <i>Lot Area</i> (Minimum) 380m² b) <i>Lot Frontage</i> (Minimum) 13.0m c) <i>Front Yard</i> (Minimum) 4.5m provided no part of the <i>structure</i> used as a <i>carport</i> or <i>garage</i> is closer than 5.5m to the <i>front lot line</i> d) <i>Interior Side Yard</i> (Minimum) 1.0m provided that on a <i>lot</i> where there is not attached <i>carport</i> or attached <i>garage</i> the minimum <i>interior side yard</i> width shall be 3.0m on one side and 1.0m on the other side e) <i>Exterior Side Yard</i> (Minimum) 3.0m f) <i>Rear Yard</i> (Minimum) 6.0m g) <i>Lot Coverage</i> (Maximum) 45% h) <i>Lot Coverage for a Dwelling</i> (Maximum) 40% <p>All other requirements of the By-Law shall apply.</p>

SECTION 8: URBAN RESIDENTIAL (R) ZONES

By-Law No.	Zone Code	Description
136-15	R1-17	<p>Notwithstanding any provisions of this By-Law to the contrary, within any area zoned R1-17 on Schedule “A” hereto, in addition to the uses permitted in the Residential First Density (R1) Zone, a <i>semi-detached dwelling</i> or <i>rowhouse dwelling</i> shall also be permitted, and the following <i>development</i> standards shall apply:</p> <p>a) <u>Single detached dwelling:</u></p> <ul style="list-style-type: none"> i) Minimum <i>front yard</i>: 4.5 metres (provided no part of the structure used as a <i>garage</i> is closer than 6.0 metres to the <i>front lot line</i>, and that no <i>garage</i> portion of a <i>dwelling</i> is located nearer to the street line than the habitable part of the <i>dwelling</i>). ii) <i>Exterior side yard</i> (minimum): 3.0 metres iii) <i>Lot Coverage</i> (maximum): 40% iv) <i>Lot Frontage</i> (minimum): 11.0 metres v) <i>Lot Area</i> (minimum): 385 square meters <p>b) <u>Rowhouse dwelling:</u></p> <ul style="list-style-type: none"> i) A <i>rowhouse dwelling</i> may also have a <i>frontage</i> on a <i>public street</i>. ii) Minimum <i>front yard</i>: 4.5 metres (provided no part of the structure used as a <i>garage</i> is closer than 6.0 metres to the <i>front lot line</i>, and that no <i>garage</i> portion of a <i>dwelling</i> is located nearer to the street line than the habitable part of the <i>dwelling</i>). iii) <i>Lot Frontage</i> (minimum): 5.5 metres iv) <i>Exterior side yard</i> (minimum): 3.0 metres v) Any yard abutting a <i>public walkway</i>: 2.0 metres vi) <i>Interior side yard</i> (minimum): 1.2 metres vii) <i>Lot Coverage</i> (maximum): 52% viii) <i>Driveway Width</i> (maximum): 3.0 meters <p>All other requirements of the By-Law shall apply</p>

SECTION 8: URBAN RESIDENTIAL (R) ZONES

By-Law No.	Zone Code	Description
174-14	R1-18	<p>Notwithstanding any provision of this By-Law to the contrary, within any area zoned R1-18 on Schedule “A” hereto, the permitted <i>uses</i> shall be limited to <i>single detached dwellings</i> and <i>accessory uses, buildings and structures</i>, subject to the following <i>zone</i> requirements:</p> <ul style="list-style-type: none"> a) Minimum <i>Lot Area</i>: 360 square metres b) Minimum <i>Lot Frontage</i>: 12 metres c) Minimum <i>Front Yard Setback</i>: 4.5 metres (provided no part of the structure used as a <i>garage</i> is closer than 5.5 metres to the <i>front lot line</i>, and that no <i>garage</i> portion of a <i>dwelling</i> is located nearer to the street line than the habitable part of the <i>dwelling</i>). d) Minimum <i>Interior Side Yard</i>: 1.2 metres on one side and 0.6 metres on the other side provided there is a minimum of 1.8 metres between <i>dwellings</i> on two attached <i>lots</i> and provided any permitted encroachment is at least 0.3 metres from a <i>lot line</i>. e) Minimum <i>Exterior Side Yard</i>: 4.5 metres f) Maximum <i>Lot Coverage</i>: 45% g) Other provisions: An uncovered <i>deck</i> shall not be considered as part of <i>lot coverage</i>. <p>All other requirements of the By-law shall apply.</p>
174-14	R1-19	<p>Notwithstanding any provision of this By-Law to the contrary, within any area zoned R1-19 on Schedule “A” hereto, the permitted <i>uses</i> shall be limited to <i>single detached dwellings</i> and <i>accessory uses, buildings and structures</i>, subject to the following <i>zone</i> requirements:</p> <ul style="list-style-type: none"> h) Minimum <i>Lot Area</i>: 345 square metres i) Minimum <i>Lot Frontage</i>: 12 metres j) Minimum <i>Front Yard Setback</i>: 3.0 metres (provided no part of the structure used as a <i>garage</i> is closer than 5.5 metres to the <i>front lot line</i>, and that no <i>garage</i> portion of a <i>dwelling</i> is located nearer to the street line than the habitable part of the <i>dwelling</i>). k) Minimum <i>Interior Side Yard</i>: 1.2 metres on one side and 0.6 metres on the other side provided there is a minimum of 1.8 metres between <i>dwellings</i> on two attached <i>lots</i> and provided any permitted encroachment is at least 0.3 metres from a <i>lot line</i>. l) Minimum <i>Rear Yard</i>: 3.0 metres m) Maximum <i>Lot Coverage</i>: 65% n) Other provisions: An uncovered <i>deck</i> shall not be considered as part of <i>lot coverage</i>. <p>All other requirements of the By-law shall apply.</p>

SECTION 8: URBAN RESIDENTIAL (R) ZONES

By-Law No.	Zone Code	Description
174-14	R1-20	<p>Notwithstanding any provision of this By-Law to the contrary, within any area <i>zoned</i> R1-20 on Schedule “A” hereto, the permitted <i>uses</i> shall be limited to <i>single detached dwelling</i> and <i>accessory uses, buildings and structures</i>, subject to the following <i>zone</i> requirements:</p> <ul style="list-style-type: none"> a) A <i>lot</i> is considered to be the land area which constitutes a unit of a <i>condominium</i> corporation and does not require <i>frontage</i> on a <i>public street</i>. b) <i>Lot area, lot frontage</i> and <i>yard setbacks</i> shall be determined as if the common element road were a <i>public street</i>. c) Maximum number of <i>dwelling units</i>: 20 d) Minimum <i>Lot Area</i>: 290 square metres e) Minimum <i>Lot Frontage</i>: 13.5 metres f) Minimum <i>Front Yard Setback</i>: 4.5 metres provided except to a <i>garage</i> which shall be 5.5 metres. g) Minimum <i>interior side yard setback</i>: 1.2 metres on one side and 0.6 metres on the other side provided there is a minimum of 1.8 metres between <i>dwelling</i>s on two attached <i>lots</i> and provided any permitted encroachment is at least 0.3 metres from <i>lot line</i>. h) Minimum <i>Exterior Side Yard</i>: 4.5 metres i) Minimum <i>Rear Yard</i>: 6 metres except any <i>lot</i> abutting a Natural Heritage (NH) <i>Zone</i> may have a minimum <i>rear yard setback</i> of 0.0 metres. j) Maximum <i>Lot Coverage</i>: 45% except any <i>lot</i> abutting a Natural Heritage (NH) <i>Zone</i> may have maximum <i>lot coverage</i> of 65%. k) Other provisions: An uncovered <i>deck</i> shall not be considered as part of <i>lot coverage</i>. <p>All other requirements of the By-law shall apply.</p>

SECTION 8: URBAN RESIDENTIAL (R) ZONES

8.4 Special Exceptions R2 Zone

By-Law No.	Zone Code	Description
Not Available	R2-1	Notwithstanding any provisions of this By-Law to the contrary, within any area <i>zoned</i> R2-1 on Schedule "A" hereto, a <i>contractor's yard</i> for a carpentry business shall also be permitted. The <i>gross floor area</i> for said <i>use</i> shall not exceed a total of 111.5 square metres and no outside storage shall be permitted. All other requirements of the By-Law shall apply.
Not Available	R2-2	Notwithstanding any provisions of this By-Law to the contrary, within any area <i>zoned</i> R2-2 on Schedule "A" hereto, a <i>medical office</i> shall also be permitted in the <i>existing dwelling</i> . All other requirements of the By-Law shall apply.
Not Available	R2-3	Notwithstanding any provisions of this By-Law to the contrary, within any area <i>zoned</i> R2-3 on Schedule "A" hereto, a lawn bowling club shall also be permitted. All other requirements of the By-Law shall apply.
Not Available	R2-4	Notwithstanding any provisions of this By-Law to the contrary, within any area <i>zoned</i> R2-4 on Schedule "A" hereto, the only <i>use</i> permitted shall be a one <i>storey, single detached dwelling</i> with no <i>accessory buildings</i> or <i>structures</i> . All other requirements of the By-Law shall apply.
Not Available	R2-5	Notwithstanding any provisions of this By-Law to the contrary, within any area <i>zoned</i> R2-5 on Schedule "A" hereto, an art <i>studio</i> and gallery having a maximum <i>gross floor area</i> of 37.2 square metres shall also be permitted. All other requirements of the By-Law shall apply.
Not Available	R2-6	Notwithstanding any provisions of this By-Law to the contrary, within any area <i>zoned</i> R2-6 on Schedule "A" hereto, a <i>service shop</i> having a maximum <i>gross floor area</i> of 46.5 square metres shall also be permitted. All other requirements of the By-Law shall apply.
Not Available	R2-7	Notwithstanding any provisions of this By-Law to the contrary, within any area <i>zoned</i> R2-7 on Schedule "A" hereto, a <i>contractor's yard</i> for construction and excavation equipment and having a maximum <i>gross floor area</i> of 92.9 square metres shall also be permitted. Outside storage <i>uses</i> shall not exceed <i>lot coverage</i> of 50%. All other requirements of the By-Law shall apply.

SECTION 8: URBAN RESIDENTIAL (R) ZONES

By-Law No.	Zone Code	Description
Not Available	R2-8	Notwithstanding any provisions of this By-Law to the contrary, within any area <i>zoned</i> R2-8 on Schedule "A" hereto, the retailing of antiques and clothing shall also be permitted. However, the total <i>gross floor area</i> for these <i>uses</i> shall not exceed 46.5 square metres. All other requirements of the By-Law shall apply.
Not Available	R2-9	Notwithstanding any provisions of this By-Law to the contrary, within any area <i>zoned</i> R2-9 on Schedule "A" hereto, in addition to the <i>uses</i> permitted in the Residential Singles and Semis (R2) <i>Zone</i> , the following <i>uses</i> shall also be permitted: <ul style="list-style-type: none"> a) office not exceeding a <i>gross floor area</i> of 55.8 square metres, b) fine art <i>studio</i>, c) <i>retail store</i>. d) <i>bakery</i> - sales only, e) the sale of beer and wine making supplies, and f) Aesthetician/ aesthetics. No outside storage shall be permitted. All other requirements of the By-Law shall apply.
Not Available	R2-10	Notwithstanding any provisions of this By-Law to the contrary, within any area <i>zoned</i> R2-10 on Schedule "A" hereto, an <i>office supply outlet</i> shall also be permitted. However, the maximum <i>gross floor area</i> for this business shall not exceed 74 square metres and outside storage shall be prohibited. All other requirements of the By-Law shall apply.
121-02	R2-11	Notwithstanding any provisions of this By-Law to the contrary, within any area <i>zoned</i> R2-11 on Schedule "A" hereto, the minimum <i>rear yard</i> requirement shall be 15 metres. All other requirements of the By-Law shall apply.
121-02	R2-12	Notwithstanding any provisions of this By-Law to the contrary, within any area <i>zoned</i> R2-12 on Schedule "A" hereto, a maximum of two <i>dwellings</i> shall be permitted. All other requirements of the By-Law shall apply.
121-02	R2-13	Notwithstanding any provisions of this By-Law to the contrary, within any area <i>zoned</i> R2-13 on Schedule "A" hereto, a gift and craft shop having a maximum <i>gross floor area</i> of 42 square metres shall also be permitted. All other requirements of the By-Law shall apply.
136-03	R2-14	Notwithstanding any provisions of this By-Law to the contrary, within any area <i>zoned</i> R2-14 on Schedule "A" hereto, the minimum <i>rear yard setback</i> shall be 1.58 metres. All other requirements of the By-Law shall apply.

SECTION 8: URBAN RESIDENTIAL (R) ZONES

By-Law No.	Zone Code	Description
158-13, 24-15	R2-15	Notwithstanding any provisions of this By-Law to the contrary, within any area <i>zoned</i> R2-15 on Schedule “A” hereto, the maximum <i>lot coverage</i> shall be 45%. All other requirements of the By-Law shall apply.
165-02, 34-07	R2-16	Notwithstanding any provisions of this By-Law to the contrary, within any area <i>zoned</i> R2-16 on Schedule “A” hereto, a <i>medical office</i> shall also be a permitted <i>use</i> . Furthermore, any parking in association with the office <i>uses</i> shall be one <i>parking space</i> for every 27.5 square metres of office space. All other requirements of the By-Law shall apply.
59-09, 39-14, 110-15	R2-17	Notwithstanding any provisions of this By-Law to the contrary, within any area <i>zoned</i> R2-17 on Schedule “A” hereto, the permitted <i>uses</i> shall be limited to <i>semi-detached dwellings</i> and <i>accessory uses, buildings and structures</i> , subject to the following <i>development</i> standards: <ul style="list-style-type: none"> a) <i>Lot Area</i> (Minimum): <ul style="list-style-type: none"> i. <i>Semi-detached dwelling</i> – 550 m² ii. <i>Semi-detached dwelling unit</i> – 260 m² b) <i>Lot Frontage</i> (Minimum): <ul style="list-style-type: none"> i. <i>Semi detached dwelling</i> – 18.0 m ii. <i>Semi detached dwelling unit</i> – 8.5 m c) Minimum <i>Front Yard</i>: 4.5 metres (provided no part of the <i>structure used</i> as a <i>garage</i> is closer than 5.5 metres to the <i>front lot line</i>). d) Minimum <i>Interior Side Yard</i>: 1.0 metres provided that on a <i>lot</i> where there is no attached <i>carport</i> or attached <i>garage</i> the minimum interior side yard width shall be 3.0m on one side. There is no interior side yard along the common <i>lot line</i> of the semi-detached unit. e) Minimum <i>Exterior Side Yard</i>: 3.0 metres f) <i>Rear Yard</i> (Minimum): 6.0 metres g) <i>Lot Coverage</i> (Maximum): 45% h) <i>Lot Coverage</i> for a <i>Dwelling</i> (Maximum): 40% <p>All other requirements of the By-Law shall apply.</p>

SECTION 8: URBAN RESIDENTIAL (R) ZONES

By-Law No.	Zone Code	Description
OMB Order PL 130478	R2-18	<p>Notwithstanding any provision of this By-Law to the contrary, within any area zoned R2-18 on Schedule 'A' hereto, the following <i>development</i> standards shall apply:</p> <ul style="list-style-type: none"> a) <i>Lot Area</i> (Minimum): <ul style="list-style-type: none"> (i) <i>Single detached dwelling</i>: 350 m² (ii) <i>Semi-detached dwelling</i>: 560 m² (iii) <i>Semi-detached dwelling unit</i>: 260 m² b) <i>Lot Frontage</i> (Minimum): <ul style="list-style-type: none"> (i) <i>Single detached dwelling</i>: 10.9 m (ii) <i>Semi-detached dwelling</i>: 18.0 m (iii) <i>Semi-detached dwelling unit</i>: 6.7 m c) <i>Front Yard</i> (Minimum): 4.5 m, provided no part of a <i>carport</i> or <i>garage</i> is closer than 6.0 m to the <i>front lot line</i>. d) <i>Interior Side Yard</i> (Minimum): 0.6 m and 1.8 m between <i>single detached dwellings</i> e) <i>Exterior Side Yard</i> (Minimum): 4.5 m f) <i>Lot Coverage</i> (Maximum): <ul style="list-style-type: none"> (i) <i>Single detached dwelling</i>: 50% (ii) <i>Semi-detached dwelling</i>: 50% <p>All other requirements of the By-Law shall apply.</p>
149-15	R2-19	<p>Notwithstanding any provision of this By-Law to the contrary, within any area zoned R2-19 on Schedule "A" hereto, an <i>accessory structure</i> with a maximum <i>height</i> of 7.4 metres, maximum <i>gross floor area</i> of 149 square metres, and the parking of one (1) <i>commercial vehicle</i> shall be permitted. All other requirements of the By-Law shall apply.</p>
78-12	R2-20	<p>Notwithstanding any provision of this By-Law to the contrary, within any area zoned R2-20 on Schedule "A" hereto, the permitted <i>uses</i> shall be limited to <i>single detached dwellings</i> and <i>accessory uses</i>, subject to the following development standards:</p> <ul style="list-style-type: none"> a) Minimum <i>lot area</i>: 360 square metres b) Minimum <i>lot frontage</i>: 11.0 metres c) Minimum <i>front yard</i>: 4.5m (provided no part of the structure used as a <i>garage</i> is closer than 6.0m to the <i>front lot line</i>, and that no <i>garage</i> portion of a <i>dwelling</i> located nearer to the <i>street line</i> than the habitable part of the <i>dwelling</i>.) d) <i>Interior side yard</i> (minimum): 1.2 m on one side and 0.6 m on the other side (provided that there is a minimum of 1.8 m between <i>dwellings</i> on two adjacent <i>lots</i> and provided that any permitted encroachment is at least 0.3 m from a <i>lot line</i>). e) <i>Exterior side yard</i> minimum: 4.5 metres f) Maximum <i>lot coverage</i>: 45% g) Other provisions: An uncovered <i>deck</i> may be considered as part of the <i>landscaped open space</i>. <p>All other requirements of the By-Law shall apply.</p>

SECTION 8: URBAN RESIDENTIAL (R) ZONES

By-Law No.	Zone Code	Description
174-14	R2-21	<p>Notwithstanding any provision of this By-Law to the contrary, within any area zoned R2-21 on Schedule “A” hereto, the permitted uses shall be limited to <i>single detached dwelling, semi-detached dwelling</i> and <i>accessory uses, buildings and structures</i>, subject to the following zone requirements:</p> <p>a) A <i>lot</i> is considered to be the land area which constitutes a unit of a <i>condominium</i> corporation and does not require <i>frontage</i> on a <i>public street</i>.</p> <p>b) <i>Lot area, lot frontage</i> and <i>yard setbacks</i> shall be determined as if the common element road were a <i>public street</i>.</p> <p>c) Maximum number of <i>dwelling units</i>: 6</p> <p>d) Minimum <i>Lot Area</i>:</p> <ul style="list-style-type: none"> i. <i>single detached dwelling</i>-350 square metres ii. <i>semi-detached dwelling</i>-475 square metres <p>e) Minimum <i>Lot Frontage</i>:</p> <ul style="list-style-type: none"> i. <i>single detached dwelling</i>-13.5 metres ii. <i>semi-detached dwelling</i>-18.0 metres iii. <i>semi-detached dwelling unit</i>-8.5 metres <p>f) Minimum <i>Front Yard Setback</i>: 4.5 metres provided except to a <i>garage</i> which shall be 5.5 metres.</p> <p>g) Minimum <i>interior side yard setback</i>: 1.2 metres on one side and 0.6 metres on the other side provided there is a minimum of 1.8 metres between <i>dwelling</i>s on two attached <i>lots</i> and provided any permitted encroachment is at least 0.3 metres from <i>lot line</i>.</p> <p>h) Minimum <i>Exterior Side Yard</i>: 4.5 metres</p> <p>i) Minimum <i>Rear Yard</i>: 6 metres</p> <p>j) Maximum <i>Lot Coverage</i>: 65%</p> <p>k) Other provisions: An uncovered <i>deck</i> shall not be considered as part of <i>lot coverage</i>.</p> <p>All other requirements of the By-law shall apply.</p>

SECTION 8: URBAN RESIDENTIAL (R) ZONES

8.5 Special Exceptions RM1 Zone

By-Law No.	Zone Code	Description
182-03	RM1-1	Notwithstanding any provisions of this By-Law to the contrary, within any area <i>zoned</i> RM1-1 on Schedule "A" hereto, in addition to the <i>uses</i> permitted in the Residential Multiple Low Density (RM1) <i>Zone</i> , a <i>service shop</i> shall also be permitted. All other requirements of the By-Law shall apply.
Not Available	RM1-2	<p>Notwithstanding any provisions of this By-Law to the contrary, within any area <i>zoned</i> RM1-2 on Schedule "A" hereto, in addition to the <i>uses</i> permitted in the Residential Multiple Low Density (RM1) <i>Zone</i>, a maximum of 30 <i>rowhouse dwelling units</i> shall be permitted.</p> <p>The following <i>development</i> standards shall apply:</p> <ul style="list-style-type: none"> a) Minimum <i>interior side yard</i> shall be 1.2 metres. b) Buffering, consisting of a <i>planting strip</i> having a minimum <i>height</i> and width of 1.52 metres and a 1.8 metre high solid wood <i>patio</i>-style privacy fence is required where the site abuts residentially <i>zoned</i> lands. c) <i>Lot Coverage</i> for all <i>accessory buildings</i> shall be restricted to a maximum <i>gross floor area</i> of 9.29 square metres and a maximum <i>building height</i> of 1.8 metres. <p>All other requirements of the By-Law shall apply.</p>
14-04, 84-04	RM1-3	<p>Notwithstanding any provision in this By-Law to the contrary, within any area <i>zoned</i> RM1-3 on Schedule 'A' hereto, the minimum <i>front yard</i> shall be 4.6 metres; and no part of any <i>building</i> or <i>structure</i>, including <i>accessory building</i> and <i>structures</i> and a swimming pool shall be located further than 13.7 metres from the <i>front lot line</i>.</p> <p>All other requirements of the By-Law shall apply.</p>
14-04, 84-04, 261-04	RM1-4	<p>Notwithstanding any provision in this By-Law to the contrary, within any area <i>zoned</i> RM1-4 on Schedule 'A' hereto, the minimum <i>front yard</i> shall be 4.6 metres; and no part of any <i>building</i> or <i>structure</i>, including <i>accessory building</i> and <i>structures</i> and a swimming pool shall be located further than 14.4 metres from the <i>front lot line</i>.</p> <p>All other requirements of the By-Law shall apply.</p>

SECTION 8: URBAN RESIDENTIAL (R) ZONES

By-Law No.	Zone Code	Description
78-05	RM1-5	<p>Notwithstanding any provision of this By-Law to the contrary, within any area zoned RM1-5 on Schedule "A" hereto, the following <i>development</i> standards shall apply:</p> <ul style="list-style-type: none"> a) <i>Uses permitted: rowhouse dwelling, street fronting rowhouse dwellings and accessory uses and structures.</i> b) <i>Lot Frontage: 6.0m</i> c) <i>Front yard: 4.5m (provided no part of the structure used as a garage is closer than 6.0m to the front lot line, and that no garage portion of a dwelling is located nearer to the street line than the habitable part of the dwelling.)</i> d) <i>Exterior Side Yard: 3.0m</i> e) <i>Any yard abutting a public walkway: 2.0m</i> f) <i>Driveway width: 3.0m (maximum)</i> <p>All other requirements of the By-Law shall apply.</p>
78-05, 146-06	RM1-6	<p>Notwithstanding any provision of this By-Law to the contrary, within any area zoned RM1-6 on Schedule "A" hereto, the following <i>development</i> standards shall apply:</p> <ul style="list-style-type: none"> a) <i>Uses permitted: rowhouse dwelling and accessory uses and structures.</i> b) <i>Lot Frontage: 6.0m</i> c) <i>Front yard: 4.5m (provided no part of the structure used as a garage is closer than 6.0m to the front lot line, and that no garage portion of a dwelling is located nearer to the street line than the habitable part of the dwelling.)</i> d) <i>Exterior Side Yard: 3.0m</i> e) <i>Interior Side Yard: 1.2 m</i> f) <i>Any yard abutting a public walkway: 2.0m</i> g) <i>Lot Coverage: 52% (maximum)</i> h) <i>Driveway width: 3.0m (maximum)</i> <p>All other requirements of the By-Law shall apply.</p>

SECTION 8: URBAN RESIDENTIAL (R) ZONES

By-Law No.	Zone Code	Description
126-09	RM1-7	<p>Notwithstanding any provision of this By-Law to the contrary, within any area zoned RM1-7 on Schedule "A" hereto, the following additional <i>uses</i> and <i>development</i> standards shall apply:</p> <p><u>Additional Use:</u></p> <ul style="list-style-type: none"> a) <i>Apartment dwelling</i> to be occupied by seniors or people having a physical disability b) maximum units, 60; <p><u>Building location:</u></p> <ul style="list-style-type: none"> a) a new <i>lot line</i> may be established with a 0.0 metre <i>setback</i> provided it abuts only land owned by the South Dumfries Non-Profit Housing Corporation; b) <i>Rear yard setback</i> (southerly), 20 metres; c) <i>Side yard setback</i>, 15 metres d) no <i>accessory building</i> or <i>structure</i> as well as <i>site alteration</i>, save and except works required for landscaping and on-site storm water management, shall be permitted within the rear and <i>side yards</i>; <p><u>Site Development</u></p> <ul style="list-style-type: none"> a) maximum <i>lot coverage</i>: 40% (<i>apartment dwelling</i>), all other <i>uses</i>: 35%; b) minimum <i>landscaped open space</i>, 30%; <p><u>Building Height</u></p> <ul style="list-style-type: none"> a) maximum <i>building height (apartment dwelling)</i>: 12.2 metres above the <i>existing</i> grading elevation at the <i>side/rear yard</i> limit ; b) maximum <i>building height (apartment dwelling)</i>: 15 metres if an average grading elevation is utilized in so far as the 12.2 metres above the <i>existing grade</i> elevation is not exceeded ; c) all other <i>uses</i>, 8.5 metres. <p>All other requirements of the By-Law shall apply.</p>

SECTION 8: URBAN RESIDENTIAL (R) ZONES

By-Law No.	Zone Code	Description																												
86-04, 44-11, 142-13	RM1-8	<p>Notwithstanding any provision of this By-Law to the contrary, within any area <i>zoned</i> RM1-8 on Schedule “C” attached hereto, the permitted <i>uses</i> are limited to <i>street fronting rowhouse dwellings</i>, a common elements <i>condominium</i> and <i>accessory uses</i>, subject to the <i>development</i> standards stated below:</p> <ul style="list-style-type: none"> a) For the purpose of determining permitted <i>use</i>, <i>development</i> standards, <i>setbacks</i>, frontage and regulations for the common element <i>condominium</i> as described in this By-Law, “<i>private street</i>” shall be considered the <i>public street</i>. b) The maximum number of <i>rowhouse dwellings</i> shall be 95 units. c) In addition to the <i>garage</i> and <i>driveway</i> of each <i>dwelling unit</i>, an additional 44 visitor <i>parking spaces</i> shall be provided. d) Visitor parking is permitted to be located within 0.1 metres to a <i>lot line</i>. e) The maximum <i>height</i> of any <i>building</i> shall be 8.5 metres. f) The following <i>setback</i> provisions shall apply: <table border="1" style="width: 100%; border-collapse: collapse;"> <thead> <tr> <th style="text-align: center;">Provision</th> <th style="text-align: center;">Unit Type A</th> <th style="text-align: center;">Unit Type B</th> <th style="text-align: center;">Unit Type C</th> </tr> </thead> <tbody> <tr> <td style="text-align: center;"><i>Lot Area</i>, Square Metres (Minimum)</td> <td style="text-align: center;">140</td> <td style="text-align: center;">140</td> <td style="text-align: center;">140</td> </tr> <tr> <td style="text-align: center;"><i>Interior Lot Frontage</i>, Metres (Minimum)</td> <td style="text-align: center;">7.2</td> <td style="text-align: center;">5.</td> <td style="text-align: center;">5.4</td> </tr> <tr> <td style="text-align: center;"><i>Exterior Lot Frontage</i>, Meters, (Minimum)</td> <td style="text-align: center;">9.0</td> <td style="text-align: center;">N/A</td> <td style="text-align: center;">N/A</td> </tr> <tr> <td style="text-align: center;"><i>Front Yard</i>, Metres (Minimum)</td> <td style="text-align: center;">5.7 (Units 75 & 92 shall be 4.4 m; Units 76 & 91 shall be 5.2 m)</td> <td style="text-align: center;">5.7</td> <td style="text-align: center;">5.7 (Unit 1 <i>front yard setback</i> shall be 5.4 m)</td> </tr> <tr> <td style="text-align: center;"><i>Interior Side Yard</i>, Metres (Minimum)</td> <td style="text-align: center;">1.5</td> <td style="text-align: center;">1.5 (Unit 38 shall be 1.2 m)</td> <td style="text-align: center;">1.5</td> </tr> <tr> <td style="text-align: center;"><i>Exterior Side Yard</i>, Metres (Minimum)</td> <td style="text-align: center;">1.8</td> <td style="text-align: center;">N/A</td> <td style="text-align: center;">N/A</td> </tr> </tbody> </table>	Provision	Unit Type A	Unit Type B	Unit Type C	<i>Lot Area</i> , Square Metres (Minimum)	140	140	140	<i>Interior Lot Frontage</i> , Metres (Minimum)	7.2	5.	5.4	<i>Exterior Lot Frontage</i> , Meters, (Minimum)	9.0	N/A	N/A	<i>Front Yard</i> , Metres (Minimum)	5.7 (Units 75 & 92 shall be 4.4 m; Units 76 & 91 shall be 5.2 m)	5.7	5.7 (Unit 1 <i>front yard setback</i> shall be 5.4 m)	<i>Interior Side Yard</i> , Metres (Minimum)	1.5	1.5 (Unit 38 shall be 1.2 m)	1.5	<i>Exterior Side Yard</i> , Metres (Minimum)	1.8	N/A	N/A
Provision	Unit Type A	Unit Type B	Unit Type C																											
<i>Lot Area</i> , Square Metres (Minimum)	140	140	140																											
<i>Interior Lot Frontage</i> , Metres (Minimum)	7.2	5.	5.4																											
<i>Exterior Lot Frontage</i> , Meters, (Minimum)	9.0	N/A	N/A																											
<i>Front Yard</i> , Metres (Minimum)	5.7 (Units 75 & 92 shall be 4.4 m; Units 76 & 91 shall be 5.2 m)	5.7	5.7 (Unit 1 <i>front yard setback</i> shall be 5.4 m)																											
<i>Interior Side Yard</i> , Metres (Minimum)	1.5	1.5 (Unit 38 shall be 1.2 m)	1.5																											
<i>Exterior Side Yard</i> , Metres (Minimum)	1.8	N/A	N/A																											

SECTION 8: URBAN RESIDENTIAL (R) ZONES

By-Law No.	Zone Code	Description								
		<table style="width: 100%; border-collapse: collapse;"> <tr> <td style="width: 33%;"><i>Rear Yard, Metres (Minimum)</i></td> <td style="width: 33%;">2.5 (abutting Willow Street)</td> <td style="width: 33%;">6.0 (Unit 62 shall be 2 m)</td> <td style="width: 33%;">5.2 m (Units 2 - 21, no buildings, structures or landscape material shall be permitted within 2 m of the rear lot line)</td> </tr> <tr> <td><i>Lot Coverage (Maximum)</i></td> <td>64%</td> <td>54%</td> <td>60%</td> </tr> </table>	<i>Rear Yard, Metres (Minimum)</i>	2.5 (abutting Willow Street)	6.0 (Unit 62 shall be 2 m)	5.2 m (Units 2 - 21, no buildings, structures or landscape material shall be permitted within 2 m of the rear lot line)	<i>Lot Coverage (Maximum)</i>	64%	54%	60%
<i>Rear Yard, Metres (Minimum)</i>	2.5 (abutting Willow Street)	6.0 (Unit 62 shall be 2 m)	5.2 m (Units 2 - 21, no buildings, structures or landscape material shall be permitted within 2 m of the rear lot line)							
<i>Lot Coverage (Maximum)</i>	64%	54%	60%							
		<p>All other requirements of the By-Law shall apply.</p> 								

SECTION 8: URBAN RESIDENTIAL (R) ZONES

By-Law No.	Zone Code	Description
59-09, 39-14, 110-15	RM1-9	<p>Notwithstanding any provisions of this By-Law to the contrary, within any area zoned RM1-9 on Schedule "A" hereto, the permitted uses shall be limited to <i>street fronting rowhouse dwellings</i> and <i>accessory uses, buildings and structures</i>, subject to the following <i>development standards</i>:</p> <ul style="list-style-type: none"> a) <i>Lot Frontage</i> (Minimum) 9.0m b) <i>Front Yard</i> (Minimum) 4.5m provided no part of the <i>structure used as a carport or garage</i> is closer than 5.5m to the <i>front lot line</i> c) <i>Interior Side Yard</i> (Minimum) 1.0m provided that on a <i>lot</i> where there is not attached <i>carport</i> or attached <i>garage</i> the minimum <i>interior side yard</i> width shall be 3.0m. There is no <i>interior side yard</i> along the common <i>lot line</i> of the <i>street fronting rowhouse dwelling</i> unit. d) <i>Exterior Side Yard</i> (Minimum) 3.0m e) <i>Lot Coverage</i> (Maximum): 40% f) <i>Driveway width</i> (Maximum): 50% of the <i>lot frontage</i> <p>All other requirements of the By-Law shall apply.</p>
OMB Order PL 130478	RM1-10	<p>Notwithstanding any provisions of this By-Law to the contrary, within any area zoned RM1-10 on Schedule "A" hereto, the following provisions shall apply:</p> <ul style="list-style-type: none"> a) <i>Lot Area</i> (Minimum): 180 m² b) <i>Lot Frontage</i> (Minimum): 6 m c) <i>Front Yard</i> (Minimum): 4.5 m, provided no part of the <i>structure used as a carport or garage</i> is closer than 6.0 m to the <i>front lot line</i>. d) <i>Interior Side Yard</i> (Minimum): 1.5 m and 3 m between <i>structures</i> e) <i>Exterior Side Yard</i> (Minimum): 4.5 m f) <i>Lot Coverage</i> (Maximum): 50% <p>All other requirements of the By-Law shall apply.</p>

SECTION 8: URBAN RESIDENTIAL (R) ZONES

By-Law No.	Zone Code	Description
136-15	RM1-11	<p>Notwithstanding any provisions of this By-Law to the contrary, within any area zoned RM1-11 on Schedule “A” hereto, the following provisions shall apply:</p> <p style="margin-left: 40px;">a) <u>Rowhouse dwelling:</u></p> <p style="margin-left: 80px;">(i) The <i>rowhouse dwelling</i> may also have <i>frontage</i> on a <i>public street</i>.</p> <p style="margin-left: 80px;">(ii) <i>Minimum Front Yard:</i> 4.5 metres (provided no part of the <i>structure used as a garage</i> is closer than 6.0 metres to the <i>front lot line</i>, and that no <i>garage</i> portion of a <i>dwelling</i> is located nearer to the <i>street line</i> than the habitable part of the <i>dwelling</i>).</p> <p style="margin-left: 80px;">(iii) <i>Lot Frontage</i> (minimum): 5.5 metres</p> <p style="margin-left: 80px;">(iv) <i>Exterior Side Yard:</i> 3.0 metres</p> <p style="margin-left: 80px;">(v) Any yard abutting a <i>public walkway:</i> 2.0 metres</p> <p style="margin-left: 80px;">(vi) <i>Interior Side Yard</i> (minimum): 1.2 metres</p> <p style="margin-left: 80px;">(vii) <i>Lot Coverage</i> (maximum): 52%</p> <p style="margin-left: 80px;">(viii) <i>Driveway Width</i> (maximum): 3.0 metres</p> <p style="margin-left: 40px;">b) <u>Single detached dwelling:</u></p> <p style="margin-left: 80px;">(i) <i>Minimum front yard:</i> 4.5 metres (provided no part of the <i>structure used as a garage</i> is closer than 6.0 metres to the <i>front lot line</i>, and that no <i>garage</i> portion of a <i>dwelling</i> is located nearer to the <i>street line</i> than the habitable part of the <i>dwelling</i>).</p> <p style="margin-left: 80px;">(ii) <i>Exterior side yard:</i> 3.0 metres</p> <p style="margin-left: 80px;">(iii) <i>Lot Coverage</i> (maximum): 40%</p> <p style="margin-left: 80px;">(iv) <i>Lot Frontage</i> (minimum): 11.0 metres</p> <p style="margin-left: 80px;">(v) <i>Lot Area</i> (minimum): 385 square metres</p> <p>All other requirements of the By-Law shall apply.</p>
131-2023	RM1-12	<p>.1 Notwithstanding any provision of this By-law to the contrary, as shown on Schedule A, attached to and forming part of this By-law, any lot within any RM1-12 Zone may be used for all of the uses permitted in the RM1 Zone plus the following use:</p> <p style="margin-left: 40px;">.1 Dwelling, Back-to-Back Rowhouse</p>

SECTION 8: URBAN RESIDENTIAL (R) ZONES

By-Law No.	Zone Code	Description
		<p>.2 For the purpose of this by-law, a Back-to-Back Rowhouse dwellings shall mean a residential building containing a minimum of 4 and a maximum of 16 units, having attached units separated by a common or party wall above grade, including a common or party rear wall without a rear yard setback, and whereby each unit has an independent entrance to the unit from the outside accessed through the front elevation or exterior side elevation of the dwelling unit.</p> <p>.3 Notwithstanding Table 8.3, where a comprehensive condominium plan has received draft plan approval, as well as any required site plan approval, and where registration of the plan is intended to occur in phases and/or stages, the lands to which the draft approved plan of condominium is to be located, shall be deemed to be one lot for the purposes of applying the provisions of the By-law. Zoning provisions shall apply only to the external lot lines of the overall condominium plan, not to internal lot lines resulting from the registration of any condominium phase</p> <p>.4 Notwithstanding any provision of this By-law to the contrary as shown on Schedule 'A', attached to and forming part of this By-law, no person shall within any RM1-12 Zone use any lot, or erect, alter or use any building or structure for a Block Townhouse Dwelling, except in accordance with the following provisions:</p> <p>.1 Number of Rowhouse Units (maximum): 89</p> <p>.2 Lot Area (minimum): 18,500 m²</p> <p>.3 Street Setback (Minimum): 3 m</p> <p>.4 Rear Yard Setback (Minimum): 7.5 m, except for the southwestern most rowhouse unit, where 3.75 m is the minimum rear yard setback measuring 25 m north from the southern lot line. Interior Yard Setback: 7 m abutting the southern lot line and 3.5 m abutting the northern lot line</p> <p>.5 Parking (minimum): Each rowhouse shall provide a minimum of 2.0 parking spaces per unit, one of which shall be provided in an integral garage and one of which shall be provided in a private driveway.</p>

SECTION 8: URBAN RESIDENTIAL (R) ZONES

By-Law No.	Zone Code	Description
		<p>Visitor Parking (minimum): A minimum of 45 visitor parking spaces shall be provided</p> <p>Accessible Parking (minimum): 4 spaces</p> <p>Parking Space Size: 2.75 m x 5.5 m</p> <p>Accessible Parking Space Size: Type 'A' – 3.4 m x 5.5 m, Type 'B' – 2.75 m x 5.5 m</p>

8.6 Special Exceptions RM2 Zone

By-Law No.	Zone Code	Description
Not Available	RM2-1	<p>Notwithstanding anything in this By-Law to the contrary, within any area <i>zoned</i> RM2-1 on Schedule "A" hereto, the following <i>lot</i> provisions shall apply:</p> <ul style="list-style-type: none"> a) <i>Lot Area</i> (Minimum): <ul style="list-style-type: none"> i) <i>Semi-detached dwelling</i>: 368 square metres ii) <i>Semi-detached dwelling unit</i>: 184 square metres b) <i>Rear yard</i>: 3.7 metres <p>All other requirements of the By-Law shall apply.</p>
Not Available	RM2-2	<p>Notwithstanding any provisions of this By-Law to the contrary, within any area <i>zoned</i> RM2-2 on Schedule "A" hereto, a <i>condominium development</i> consisting of a maximum of 36 units shall also be permitted. The minimum <i>front yard</i> shall be 7.6 metres.</p> <p>All other requirements of the By-Law shall apply.</p>
41-14, 67-11, 110-15, 59-09	RM2-3	<p>Notwithstanding any provisions of this By-Law to the contrary, within any area <i>zoned</i> RM2-3 on Schedule "A" hereto, the following <i>development</i> standards shall apply:</p> <ul style="list-style-type: none"> a) The minimum <i>interior side yard</i> shall be 3.0 metres; b) The minimum <i>rear yard</i> shall be 4.7 metres; c) The minimum distance between two <i>buildings</i> containing <i>rowhouse dwellings</i> shall be 13.0 metres. <p>All other requirements of the By-Law shall apply.</p>
97-12	RM2-4	<p>Notwithstanding any provision of this By-Law to the contrary, within any area <i>zoned</i> RM2-4 on Schedule "A" hereto, the</p>

SECTION 8: URBAN RESIDENTIAL (R) ZONES

By-Law No.	Zone Code	Description
		maximum <i>height</i> of any building or <i>structure</i> shall be 7.0 metres. All other requirements of the By-Law shall apply.
59-09, 39-14, 110-15	RM2-5	<p>Notwithstanding any provisions of this By-law to the contrary, within any area <i>zoned</i> RM2-5 on Schedule “A” hereto, the <i>uses</i> permitted shall be limited to <i>rowhouse dwellings</i> and <i>accessory uses, buildings</i> and <i>structures</i>, subject to the following <i>development</i> standards:</p> <ul style="list-style-type: none"> a) <i>Front Lot Line</i>: Eastern <i>lot</i> line b) <i>Front Yard</i> (minimum): 3.0m c) <i>Exterior Side Yard</i> (Minimum): 3.0m d) (Maximum): 4.5m e) <i>Privacy Yard</i> (Minimum): 6.0m f) A <i>privacy yard</i> shall be provided adjoining each rear exterior wall of each <i>dwelling unit</i> that contains a <i>habitable room</i> window. g) <i>Building Separation</i>: N/A <p>All other requirements of the By-Law shall apply.</p>
136-15	RM2-6	<p>Notwithstanding any provisions of this By-Law to the contrary, within any area <i>zoned</i> RM2-6 on Schedule “A” hereto, the following provisions shall apply to <i>rowhouse dwellings</i>:</p> <ul style="list-style-type: none"> a) The <i>rowhouse dwelling</i> may also have <i>frontage</i> on a <i>public street</i>. b) Minimum <i>Front Yard</i>: 4.5 metres (provided no part of the <i>structure</i> used as a <i>garage</i> is closer than 6.0 metres to the <i>front lot line</i>, and that no <i>garage</i> portion of a <i>dwelling</i> is located nearer to the <i>street line</i> than the <i>habitable</i> part of the <i>dwelling</i>.) c) <i>Lot Frontage</i> (minimum): 6.0 metres d) <i>Exterior Side Yard</i> (Minimum): 3.0 metres e) <i>Interior Side Yard</i> (minimum): 1.2 metres f) <i>Rear Yard</i> (Minimum): 10.0 metres g) <i>Lot Coverage</i> (Maximum): 45% h) <i>Privacy yards</i> (minimum): 6.0 metres adjoining each

SECTION 8: URBAN RESIDENTIAL (R) ZONES

By-Law No.	Zone Code	Description
		<p style="text-align: center;">exterior wall of every <i>dwelling unit</i>.</p> <p>All other requirements of the By-Law shall apply.</p>
OMB Order PL 130478	RM2-7	<p>Notwithstanding any provision of this By-Law to the contrary, within any area <i>zoned</i> RM2-7 on Schedule 'A' hereto, will be subject to the following <i>development</i> standards:</p> <p>a) For <i>street fronting rowhouse dwellings</i> the following minimum standards shall apply:</p> <ul style="list-style-type: none"> (i) <i>Lot Area</i> (Minimum): 180 m² (ii) <i>Lot Frontage</i> (Minimum): 6.0 m (iii) <i>Front Yard</i> (Minimum): 4.5 m, provided no part of the <i>structure used as a carport or garage</i> is closer than 6.0 m to the <i>front lot line</i>. (iv) <i>Interior Side Yard</i> (Minimum): 1.5 m (v) <i>Exterior Side Yard</i> (Minimum): 4.5 m (vi) <i>Lot Coverage</i> (Maximum): 50% <p>b) For <i>row house dwellings</i> the following minimum <i>development</i> standards shall apply:</p> <ul style="list-style-type: none"> (i) The <i>rowhouse dwelling</i> may also have <i>frontage</i> on a <i>public street</i>. (ii) <i>Lot Area</i> (Minimum): 180 m² (iii) <i>Front Yard</i> (Minimum): 4.5 m, provided no part of the <i>structure used as a carport or garage</i> is closer than 6.0 m to the <i>front lot line</i>. (iv) <i>Interior Side Yard</i> (Minimum): 1.5 m (v) <i>Exterior Side Yard</i> (Minimum): 4.5 m (vi) <i>Lot Coverage</i> (Maximum): 50% (vii) <i>Rowhouse dwellings</i> may have <i>frontage</i> on a <i>public street</i>. <p>All other requirements of the By-Law shall apply.</p>

SECTION 8: URBAN RESIDENTIAL (R) ZONES

By-Law No.	Zone Code	Description
23-16	RM2-8	<p>Notwithstanding any provision of this By-Law to the contrary, within any area <i>zoned</i> RM2-8 on Schedule “A” hereto, the following shall apply;</p> <ul style="list-style-type: none"> a) <i>Rowhouse dwelling</i> development shall be permitted; b) A lot is considered to be the land area which constitutes a unit of a condominium corporation; c) <i>Lot area, lot frontage</i>, and yards shall be determined as if the common element road were a public street; d) Adjacent shall mean abutting or separated by a portion of the common element; e) Building Separation (Minimum) 3.0m f) <i>Front Yard Per Block</i> (Minimum) 4.5m g) <i>Front Yard Per Unit</i> (Minimum) 7.0m h) <i>Interior Side Yard</i> (Minimum) 1.5m i) <i>Exterior Side Yard</i> (Minimum) 1.5m j) <i>Lot Coverage</i> (Maximum) 60% k) <i>Landscaped Open Space</i> (Minimum) 25% <p>All other requirements of the By-Law shall apply.</p>
174-14	RM2-9	<p>Notwithstanding any provision of this By-Law to the contrary, within any area <i>zoned</i> RM2-9 on Schedule “A” hereto, in addition to uses permitted in Residential Multiple Medium Density (RM2) <i>Zone</i>, a <i>retirement home</i> shall also be permitted in accordance with the provisions of RM2 <i>Zone</i>. All other <i>uses</i> are subject to the following <i>zone</i> requirements:</p> <ul style="list-style-type: none"> a) A <i>lot</i> is considered to be the land area which constitutes a unit of a <i>condominium</i> corporation and does not require <i>frontage</i> on a <i>public street</i>. b) <i>Lot area, lot frontage and yard setbacks</i> shall be determined as if the common element road were a <i>public street</i>. c) Minimum <i>Front Yard Setback</i>: 4.5 metres provided except to a <i>garage</i> which shall be 5.5 metres d) Minimum <i>Interior Side Yard Setback</i>: 3.0 metres e) Minimum <i>Exterior Side Yard Setback</i>: 4.5 metres f) Minimum <i>Rear Yard Setback</i>: 6.0 metres g) Other provisions: An uncovered <i>deck</i> shall not be considered as part of <i>lot coverage</i>. <p>All other requirements of the By-Law shall apply.</p>

SECTION 8: URBAN RESIDENTIAL (R) ZONES

8.7 Special Exceptions RM3 Zone

By-Law No.	Zone Code	Description
62-02, 149-03	RM3-1	Notwithstanding any provisions of this By-Law to the contrary, within any area <i>zoned</i> RM3-1 on Schedule 'A' hereto, the maximum <i>height</i> of any <i>building</i> shall be 10.5 metres. All other requirements of the By-Law shall apply.
95-05, 121-02	RM3-2	Notwithstanding any provision of this By-Law to the contrary, within any area <i>zoned</i> RM3-2 on Schedule "A" hereto, an <i>apartment dwelling</i> limited to 36 units shall be permitted and parking for the <i>apartment dwelling</i> shall be provided at a rate of 2 spaces per unit. All other requirements of the By-Law shall apply.

SECTION 8: URBAN RESIDENTIAL (R) ZONES

By-Law No.	Zone Code	Description
136-15, 137-15, PL121076	RM3-3	<p>Notwithstanding any provision of this By-Law to the contrary, within any area zoned RM3-3 on Schedule 'A' hereto, in addition to the uses permitted in the Residential Multiple High Density (RM3) Zone, the following uses and provisions shall apply:</p> <p>a) <u>Apartment dwelling:</u></p> <ul style="list-style-type: none"> i) Number of <i>apartment dwellings</i> permitted: 125 (maximum) ii) Number of <i>parking spaces</i> required: 1.25 spaces per unit <p>b) <u>Rowhouse dwelling in accordance with the following provisions:</u></p> <ul style="list-style-type: none"> i) The <i>rowhouse dwelling</i> may also have <i>frontage</i> on a <i>public street</i>. ii) Minimum <i>Front Yard</i>: 4.5 metres (provided no part of the <i>structure used as a garage</i> is closer than 6.0 metres to the <i>front lot line</i>, and that no <i>garage</i> portion of a <i>dwelling</i> is located nearer to the <i>street line</i> than the habitable part of the <i>dwelling</i>.) iii) <i>Lot Frontage</i> (minimum): 6.0 metres iv) <i>Exterior side yard</i>: 3.0 metres v) <i>Interior side yard</i> (minimum): 1.2 metres vi) <i>Lot Coverage</i> (maximum): 45% vii) Privacy yards (minimum): 6.0 metres adjoining each rear exterior wall of every <i>dwelling unit</i>. <p>c) <u>Street fronting rowhouse dwelling:</u></p> <ul style="list-style-type: none"> i) Minimum <i>Front Yard</i>: 4.5 metres (provided no part of the <i>structure used as a garage</i> is closer than 6.0 metres to the <i>front lot line</i>, and that no <i>garage</i> portion of a <i>dwelling</i> is located nearer to the <i>street line</i> than the habitable part of the <i>dwelling</i>.) ii) <i>Lot Frontage</i> (minimum): 5.5 metres iii) <i>Exterior side yard</i>: 3.0 metres iv) Any yard abutting a <i>public walkway</i>: 2.0 metres v) <i>Interior side yard</i> (minimum): 1.2 metres vi) <i>Lot Coverage</i> (maximum): 52% vii) <i>Driveway Width</i> (maximum): 3.0 metres <p>d) <u>Single detached dwelling:</u></p> <ul style="list-style-type: none"> i) Minimum <i>front yard</i>: 4.5 metres (provided no part of the <i>structure used as a garage</i> is closer than 6.0 metres to the <i>front lot line</i>, and that no <i>garage</i> portion of a <i>dwelling</i> is located nearer to the <i>street line</i> than the habitable part of the <i>dwelling</i>.) ii) <i>Exterior side yard</i>: 3.0 metres iii) <i>Lot Coverage</i> (maximum): 40% iv) <i>Lot Frontage</i> (minimum): 11.0 metres <p>All other requirements of the By-Law shall apply.</p>

SECTION 8: URBAN RESIDENTIAL (R) ZONES

By-Law No.	Zone Code	Description
167-05, 192-06	RM3-4	<p>Notwithstanding any provision of this By-Law to the contrary, within any area <i>zoned</i> RM3-4 on Schedule “A” hereto, the following <i>development</i> standards shall apply:</p> <ul style="list-style-type: none"> a) Minimum <i>Front Yard Setback</i>: 0.0m b) Minimum <i>Left Side Yard Setback</i>: 4.1m c) Minimum <i>Right Side Yard Setback</i>: 0.0m d) Minimum <i>Rear Yard Setback</i>: 9.5m e) <i>Lot Coverage (Max)</i>:42% <p>These provisions apply to the <i>building</i>, as it existed July 1, 2005.</p> <ul style="list-style-type: none"> f) <i>Parking Spaces (min)</i>: 26 g) <i>Accessible Parking Space (min)</i>: 2 <p>The <i>parking spaces</i> may be located off-site, within 60 metres of the site.</p> <p>All other requirements of the By-Law shall apply.</p>
213-02, 183-07	RM3-5	<p>Notwithstanding any provision of this By-Law to the contrary, within any area <i>zoned</i> RM3-5 on Schedule “A” hereto, principal access to an <i>apartment dwelling</i> unit may be directly from the outside of the <i>building</i> and, furthermore the <i>Zone</i> requirements shall be as follows:</p> <ul style="list-style-type: none"> a) <i>Apartment dwelling</i> units (maximum): 21 b) <i>Front yard</i> (minimum) 7.0m c) <i>Right (west) side yard</i> (minimum) 3.0m, except if the elevation of the of the first floor of apartments is greater than 1.5m above <i>grade</i>, in which case the minimum right (west) <i>side yard</i> shall be 4.2m d) <i>Privacy yard</i>: not required e) <i>Parking spaces</i> (minimum): 30, two (2) of which shall be designated for people with disabilities <p>All other requirements of the By-Law shall apply.</p>
229-07, 205-11, 31-09	RM3-6	<p>Notwithstanding any provision of this By-Law to the contrary, within any area <i>zoned</i> RM3-6 on Schedule “A” hereto, the minimum <i>floor area</i> of a one bedroom apartment shall be 50.0 square metres. All other requirements of the By-Law shall apply.</p>

SECTION 8: URBAN RESIDENTIAL (R) ZONES

By-Law No.	Zone Code	Description
59-09, 39-14, 110-15	RM3-7	<p>Notwithstanding any provisions of this By-Law to the contrary, within any area <i>zoned</i> RM3-7 on Schedule “A” hereto, the permitted <i>uses</i> shall be limited to <i>apartment dwelling</i>, <i>continuum-of-care facilities</i> and <i>accessory uses, buildings and structures</i>, subject to the following <i>development</i> standards:</p> <ul style="list-style-type: none"> a) <i>Front lot Line</i>: Easterly <i>lot line</i> b) <i>Lot Area</i>: 90m² c) <i>Lot Frontage</i> (Minimum): 30.0m d) <i>Front Yard</i> (Minimum): 7.5m e) <i>Interior Side Yard</i> (Minimum): 3.0m f) <i>Exterior Side Yard</i> (Minimum): 3.0m g) <i>Exterior Side Yard</i> (Maximum): 6.0m h) <i>Rear Yard</i> (Minimum): 3.0m i) <i>Rear Yard</i> (Maximum): 6.0m j) <i>Building Height</i> (Maximum): 20.0m k) <i>Privacy Yards</i>: N/A l) <i>Building Separation</i>: N/A <p>All other requirements of the By-Law shall apply.</p>
174-10	RM3-8	<p>Notwithstanding any provision of this By-Law to the contrary, within any area <i>zoned</i> RM3-8 on Schedule “A” hereto, the following <i>development</i> standards shall apply:</p> <ul style="list-style-type: none"> a) Maximum number of <i>Dwelling Units</i>: 104 b) Minimum <i>Front Yard Setback</i>: 7.5 metres c) Minimum <i>Interior Side Yard Setback</i>: 10 metres d) Minimum <i>Rear Yard Setback</i>: 7.5 metres. A parking structure may have a minimum <i>rear yard</i> of 3.0 metres provided it extends no greater than 1 metre above the finished grade. e) Maximum <i>Height</i>: 12 storeys <p>All other requirements of the By-Law shall apply.</p>

SECTION 9: NON-URBAN RESIDENTIAL (NUR) ZONES

9.1 Uses Permitted

No *person* shall within any Non-Urban Residential (NUR) *Zones*, use any *lot* or *erect, alter* or use any *building* or *structure* for any purpose except for one or more of the following *uses* as identified by a “dot”:

The Non-Urban Residential *Zones* established by this By-Law are as follows:

SR	Suburban Residential
RH	Residential Hamlet and Villages
RR	Rural Residential

Table 9.1: Uses Permitted

List of Uses	SR	RH	RR
<i>Dwelling, Single Detached</i>	•	•	•
<i>Group Home</i>		•	

9.2 Zone Requirements

No *person* shall within any Non-Urban Residential (NUR) *Zones*, use any *lot* or *erect, alter* or use any *building* or *structure* except in accordance with the following provisions.

Suburban Residential (SR) *Zone* and Residential Hamlet (RH) *Zone* are intended for *development* with or without a municipal water supply. Rural Residential (RR) *Zone* is intended for *development* having *private* services.

SECTION 9: NON-URBAN RESIDENTIAL (NUR) ZONES

Table 9.2: Zone Provisions

Zones Provision	SR and RH		RR
	Partial Services	Private Services	
Lot Area , Minimum (square metres)	1000	3000	4000
Lot Frontage , Minimum (metres)	20.0	30.0	40.0
Street Setback , Minimum (metres)	7.5		20.0
Interior Side Yard Setback , Minimum (metres)	1.5		5.0
Rear Yard Setback , Minimum (metres)	7.5		15.0
Lot Coverage , Maximum	30%		30%
Landscaped Open Space , Minimum	30%		30%
Building Height , Maximum (metres)	10.5		10.5

9.3 Special Exceptions SR Zone

By-Law No.	Zone Code	Description
148-15	SR-1	Notwithstanding any provision of this By-Law to the contrary, within any area <i>zoned</i> SR-1 on Schedule “A” hereto, the permitted <i>uses</i> shall be limited to one (1) <i>dwelling unit</i> within the <i>existing building</i> on the first floor, two (2) <i>dwelling units</i> within the same <i>building</i> on the second floor, an office for a contractors business or service office on the first floor. All parking associated with the permitted <i>uses</i> shall be contained on the <i>lot</i> . All other requirements of the By-Law shall apply.

SECTION 9: NON-URBAN RESIDENTIAL (NUR) ZONES

By-Law No.	Zone Code	Description
05-05, 224-07	SR-2	<p>Notwithstanding any provision of this By-Law to the contrary, within any area <i>zoned</i> SR-2 on Schedule 'A' hereto, an aviary, with a <i>floor area</i> not greater than 34.0 square meters, may be permitted as a residential <i>home occupation</i> within an <i>existing accessory building</i>, and the following shall apply to the to the aviary:</p> <p style="padding-left: 40px;">a) At no time are more than an aggregate of 50 lovebirds, parrots and budgies permitted in the aviary portion of the <i>accessory building</i>, all of which must be no larger than 25 centimetres in length, measured from top of head to bottom of tail.</p> <p>All other requirements of the By-Law shall apply.</p>
55-08	SR-3	<p>Notwithstanding any provision of this By-Law to the contrary, within any area <i>zoned</i> SR-3 on Schedule "A" hereto, the following regulations shall apply:</p> <p style="padding-left: 40px;">a) an <i>accessory building</i> with a maximum <i>height</i> of 7.6 metres</p> <p style="padding-left: 40px;">b) the maximum coverage of all <i>accessory buildings</i> shall be 186 square metres</p> <p style="padding-left: 40px;">c) The parking or storing of a <i>commercial vehicle</i> shall not be permitted.</p> <p>All other requirements of the By-Law shall apply.</p>
104-08	SR-4	<p>Notwithstanding any provision of this By-Law to the contrary, within any area <i>zoned</i> SR-4 on Schedule "A" hereto, <i>development</i> of these lands shall be in compliance with the regulations of the Agricultural (A) <i>Zone</i>, except that any <i>livestock use</i> or <i>livestock buildings</i>, shall not be permitted. All other requirements of the By-Law shall apply.</p>
142-08	SR-5	<p>Notwithstanding any provision of this By-Law to the contrary, within any area <i>zoned</i> SR-5 on Schedule "A" hereto, the total <i>lot coverage</i> of <i>accessory buildings</i> shall be 185 square metres and the <i>height</i> of one <i>accessory building</i> shall be 7.0 metres. All other requirements of the By-Law shall apply.</p>
58-09	SR-6	<p>Notwithstanding any provision of this By-Law to the contrary, within any area <i>zoned</i> SR-6 on Schedule "A" hereto, the minimum <i>front yard setback</i> shall be 20.0 metres. All other requirements of the By-Law shall apply.</p>
165-09	SR-7	<p>Notwithstanding any provision of this By-Law to the contrary, within any area <i>zoned</i> SR-7 on Schedule "A" hereto, the total <i>lot coverage</i> for all the <i>accessory buildings</i> shall be 270 square meters with a maximum <i>height</i> of 6.1 meters. All other requirements of the By-Law shall apply.</p>

SECTION 9: NON-URBAN RESIDENTIAL (NUR) ZONES

By-Law No.	Zone Code	Description
201-11	SR-8	<p>Notwithstanding any provision of this By-Law to the contrary, within any area <i>zoned</i> SR-8 on Schedule “A” hereto, in addition to <i>uses</i> permitted in the Suburban Residential (SR) <i>Zone</i>, a <i>service shop</i> and <i>contractor’s yard</i> for an arborist and a tree cutting business including an area for associated <i>open storage</i> of timber and logs shall also be permitted, subject to the following:</p> <ul style="list-style-type: none"> a) The total coverage of all <i>buildings</i> associated with the <i>use</i> shall not exceed an aggregate area of 560 square metres and the maximum <i>height</i> of said <i>building</i> shall not exceed 5.0 metres; b) The minimum <i>interior side yard</i> for said <i>buildings</i> shall be 3.0 metres; c) The outside storage area shall not be greater than 4,000 square metres and the height of store material shall not exceed 4.0 metres; and d) no more than nine (9) <i>vehicles</i> related to the business may be on the site; <p>All other provisions of the By-Law shall apply.</p>
180-13	SR-9	<p>Notwithstanding any provision of this By-law to the contrary, within any area <i>zoned</i> SR-9 on Schedule “A” hereto, one (1) <i>accessory building</i> with a maximum <i>lot coverage</i> of 130 square metres and a maximum <i>height</i> of 5.5 metres, with an overall combined <i>floor area</i> of 185 square metres for all <i>accessory structures</i> on the <i>lot</i> shall be permitted. All other requirements of the By-Law shall apply.</p>
196-13	SR-10	<p>Notwithstanding any provision of this By-Law to the contrary, within any area <i>zoned</i> SR-10 on Schedule “A” hereto, two <i>single detached dwellings</i> and four <i>existing farm greenhouses</i> shall be permitted. All other requirements of the By-Law shall apply.</p>
Not Available	SR-11	<p>Notwithstanding any provision of this By-Law to the contrary, within any area <i>zoned</i> SR-11 on Schedule “A” hereto, a <i>dance studio</i> and a <i>service shop</i> for a heating and cooling business shall also be permitted. All other requirements of the By-Law shall apply.</p>
Not Available	SR-12	<p>Notwithstanding any provision of this By-Law to the contrary, within any area <i>zoned</i> SR-12 on Schedule “A” hereto, a <i>service shop</i> shall also be permitted. All other requirements of the By-Law shall apply.</p>

SECTION 9: NON-URBAN RESIDENTIAL (NUR) ZONES

By-Law No.	Zone Code	Description
Not Available	SR-13	Notwithstanding any provision of this By-Law to the contrary, within any area <i>zoned</i> SR-13 on Schedule "A" hereto, truck parking shall also be permitted provided that the <i>lot coverage</i> for any <i>building</i> or <i>uses</i> associated with the truck <i>use</i> is limited to 5% maximum coverage of the <i>lot</i> . All other requirements of the By-Law shall apply.
Not Available	SR-14	Notwithstanding any provisions of this By-Law to the contrary, within any area <i>zoned</i> SR-14 on Schedule "A" hereto, in addition to the <i>uses</i> permitted in the Suburban Residential (SR) <i>Zone</i> , a <i>funeral home</i> shall also be permitted. All other requirements of the By-Law shall apply.
Not Available	SR-15	Notwithstanding any provisions of this By-Law to the contrary, within any area <i>zoned</i> SR-15 on Schedule "A" hereto, in addition to the <i>uses</i> permitted in the Suburban Residential (SR) <i>Zone</i> , a <i>private hospital</i> and home for the aged shall also be permitted. All other requirements of the By-Law shall apply.
Not Available	SR-16	Notwithstanding any provisions of this By-Law to the contrary, within any area <i>zoned</i> SR-16 on Schedule "A" hereto, in addition to the <i>uses</i> permitted in the Suburban Residential (SR) <i>Zone</i> , a vending supply business involving the storage, maintaining and retailing of machines and vending supplies shall also be permitted as a <i>home occupation</i> . All other requirements of the By-Law shall apply.
Not Available	SR-17	Notwithstanding any provisions of this By-Law to the contrary, within any area <i>zoned</i> SR-17 on Schedule "A" hereto, in addition to the <i>uses</i> permitted in the Suburban Residential (SR) <i>Zone</i> , the growing and retailing of nursery products and related supplies shall also be permitted. The maximum <i>lot coverage</i> for such <i>use</i> shall be 80%. All other requirements of the By-Law shall apply.
Not Available	SR-18	Notwithstanding any provisions of this By-Law to the contrary, within any area <i>zoned</i> SR-18 on Schedule "A" hereto, in addition to the <i>uses</i> permitted in the Suburban Residential (SR) <i>Zone</i> , a repair and retailing of furniture shop shall also be permitted with a maximum <i>floor area</i> of 40 square metres. All other requirements of the By-Law shall apply.
Not Available	SR-19	Notwithstanding any provision of this By-Law to the contrary, within any area <i>zoned</i> SR-19 on Schedule "A" hereto, the repair and retailing of antiques shall also be permitted with a maximum <i>gross floor area</i> of 80 square metres. All other requirements of the By-Law shall apply.

SECTION 9: NON-URBAN RESIDENTIAL (NUR) ZONES

By-Law No.	Zone Code	Description
Not Available	SR-20	Notwithstanding the provisions of this By-Law to the contrary, within any area <i>zoned</i> SR-20 on Schedule "A" hereto, an <i>auto body shop</i> limited to a maximum <i>lot coverage</i> of 10% shall also be permitted. A privacy fence or tree planting screen shall be located along the southerly, easterly and westerly boundaries of the lands, and any <i>building</i> or <i>use</i> associated with the <i>auto body shop</i> shall be located within 45 metres of the <i>rear lot line</i> . All other requirements of the By-Law shall apply.
121-02	SR-21	Notwithstanding the provisions of this By-Law to the contrary, within any area <i>zoned</i> SR-21 on Schedule "A" hereto, the storing, display and retailing of wicker products shall also be permitted. This <i>use</i> shall be limited to a maximum <i>floor area</i> of 55 square metres and 6 <i>parking spaces</i> shall be required. All other requirements of the By-Law shall apply.
121-02	SR-22	Notwithstanding the provisions of this By-Law to the contrary, within any area <i>zoned</i> SR-22 on Schedule "A" hereto, a business involved in the display and retail of floor coverings, windows, doors, kitchen and bathroom accessories occupying no more than 550 square metres shall be permitted. All other requirements of the By-Law shall apply.
84-13	SR-23	Notwithstanding any provision of this By-law to the contrary, within any area <i>zoned</i> SR-23 on Schedule "A" hereto, one (1) <i>accessory building</i> with a maximum area of 153 square metres shall be permitted. All other requirements of the By-Law shall apply.
146-02	SR-24	Notwithstanding any provision of this By-Law to the contrary, within any area <i>zoned</i> SR-24 on Schedule 'A' hereto, the minimum <i>interior side yard</i> width shall be 15 metres. All other requirements of the By-Law shall apply.
Not Available	SR-25	Notwithstanding any provision of this By-Law to the contrary, within any area <i>zoned</i> SR-25 on Schedule "A" hereto, in addition to the <i>uses</i> permitted in the Suburban Residential (SR) <i>Zone</i> , a <i>second dwelling unit</i> attached to the <i>main dwelling unit</i> shall also be permitted. All other requirements of the By-Law shall apply.
135-03	SR-26	Notwithstanding any provision of this By-Law to the contrary, within any area <i>zoned</i> SR-26 on Schedule 'A' hereto, an <i>accessory dwelling unit</i> , not smaller than 40 square metres and not larger than 92.9 square metres, within the <i>main dwelling</i> shall be permitted. All other requirements of the By-Law shall apply.

SECTION 9: NON-URBAN RESIDENTIAL (NUR) ZONES

By-Law No.	Zone Code	Description
74-02	SR-27	Notwithstanding the provisions of this By-Law to the contrary, within any area <i>zoned</i> SR-27 on Schedule 'A' hereto, the minimum <i>floor area</i> of a one-storey <i>dwelling</i> shall 150 square metres, and the minimum <i>floor area</i> of any other <i>dwelling</i> shall be 200 square metres. All other requirements of the By-Law shall apply.
Not Available	SR-28	Notwithstanding any provision of this By-Law to the contrary, within any area <i>zoned</i> SR-28 on Schedule "A" hereto, in addition to the <i>uses</i> permitted in the Suburban Residential (SR) <i>Zone</i> , the parking of one tractor trailer truck but no <i>structures accessory</i> to the truck parking shall also be permitted. All other requirements of the By-Law shall apply.
Not Available	SR-29	Notwithstanding any provisions of this By-Law to the contrary, within any area <i>zoned</i> SR-29 on Schedule "A" hereto, in addition to the <i>uses</i> permitted in the Suburban Residential (SR) <i>Zone</i> , a <i>service shop</i> and associated outside storage area not exceeding 12 metres by 7.5 metres shall also be permitted. A minimum <i>front yard</i> of 15 metres and a minimum <i>side yard</i> of 15 metres shall also be required. All other requirements of the By-Law shall apply.
Not Available	SR-30	Notwithstanding any provisions of this By-Law to the contrary, within any area <i>zoned</i> SR-30 on Schedule "A" hereto, in addition to the <i>uses</i> permitted in the Suburban Residential (SR) <i>Zone</i> , a <i>service shop</i> shall also be permitted. No outdoor storage shall be permitted. All other requirements of the By-Law shall apply.
Not Available	SR-31	Notwithstanding any provisions of this By-Law to the contrary, within any area <i>zoned</i> SR-31 on Schedule "A" hereto, an <i>automobile repair garage</i> shall also be permitted. Maximum <i>floor area</i> for the garage shall be 145 square metres and no outside storage of parts or materials shall be permitted. All other requirements of the By-Law shall apply.

SECTION 9: NON-URBAN RESIDENTIAL (NUR) ZONES

9.4 Special Exceptions RH Zone

By-Law No.	Zone Code	Description
95-05	RH-1	Notwithstanding anything in this By-Law to the contrary, within any area <i>zoned</i> RH-1 on Schedule "A" hereto, no frontage on a <i>public street</i> shall be required. All other requirements of the By-Law shall apply.
224-06	RH-2	Notwithstanding any provision in this By-Law to the contrary, within any area <i>zoned</i> RH-2 on Schedule 'A' hereto, the minimum <i>west side yard setback</i> shall be 20.0 metres. All other requirements of the By-Law shall apply.
93-07	RH-3	Notwithstanding any provision of this By-Law to the contrary, within any area <i>zoned</i> RH-3 on Schedule "A" hereto, an <i>accessory building</i> with a total <i>gross floor area</i> of 158 square metres and a <i>height</i> of 6.1 metres shall be permitted. The <i>building</i> may be <i>used</i> for the indoor storage of equipment and materials for a landscaping business. All other requirements of the By-Law shall apply.
14-09	RH-4	Notwithstanding any provision of this By-Law to the contrary, within any area <i>zoned</i> RH-4 on Schedule "A" hereto, an <i>accessory building</i> with a maximum <i>height</i> of 7.6 metres shall be permitted and the maximum coverage of all <i>accessory buildings</i> shall not exceed 160.5 square metres. All other requirements of the By-Law shall apply.
90-11	RH-5	Notwithstanding any provision of this By-law to the contrary, within any area <i>zoned</i> RH-5 on Schedule "A" hereto, the total <i>gross floor area</i> of all <i>accessory buildings</i> and <i>structures</i> shall be 150 square meters with a maximum <i>height</i> of 11.6 metres shall be permitted. All other requirements of the By-Law shall apply.
75-12	RH-6	Notwithstanding any provision of this By-Law to the contrary, within any area <i>zoned</i> RH-6 on Schedule "A" hereto, in addition to the <i>uses</i> permitted in the Residential Hamlet (RH) <i>Zone</i> , <i>vehicle</i> sales and an <i>automobile repair garage</i> shall also be permitted, subject to the following requirements: <ul style="list-style-type: none"> a) no more than six (6) <i>vehicles</i> may be located on the <i>lot</i> for sales or repair at any time; b) sales and repair be limited to the sales and repair of passenger cars and light trucks, no sales or repair of a <i>commercial vehicle</i> is permitted. All other requirements of the By-Law shall apply.

SECTION 9: NON-URBAN RESIDENTIAL (NUR) ZONES

By-Law No.	Zone Code	Description
56-05, 53-13	RH-7	Notwithstanding any provision of this By-Law to the contrary, within any area <i>zoned</i> RH-7 on Schedule "A" hereto, in addition to the <i>uses</i> permitted in the Residential Hamlet (RH) <i>Zone</i> the maximum number of <i>livestock</i> units permitted in a barn <i>existing</i> as of January 1, 2005, shall be five (5) and the <i>livestock</i> shall be restricted to Animal Group One as described on Schedule "B" of the By-Law (horses and/or chicken broilers). All other requirements of the By-Law shall apply.
177-13	RH-8	Notwithstanding any provision of this By-Law to the contrary, within any area <i>zoned</i> RH-8 on Schedule "A" hereto, one (1) <i>accessory building</i> with a maximum <i>floor area</i> of 154 square metres and a maximum <i>height</i> of 5.4metres shall be permitted. All other requirements of the By-Law shall apply.
Not Available	RH-9	Notwithstanding any provisions of this By-Law to the contrary, within any area <i>zoned</i> RH-9 on Schedule "A" hereto, in addition to the <i>uses</i> permitted in Residential Hamlet (RH) <i>Zone</i> , the parking of two <i>transport</i> trucks and <i>trailers</i> shall also permitted. All other requirements of the By-Law shall apply.
Not Available	RH-10	Notwithstanding any provisions of this By-Law to the contrary, within any area <i>zoned</i> RH-10 on Schedule "A", a cartage and <i>transport/truck terminal</i> shall also be permitted. All other requirements of the By-Law shall apply.
Not Available	RH-11	Notwithstanding the provisions of this By-Law to the contrary, within any area <i>zoned</i> RH-11 on Schedule "A" hereto, in addition to the <i>uses</i> permitted in the Residential Hamlet (RH) <i>Zone</i> , an <i>abattoir</i> shall be permitted subject to it being located a minimum of 120 metres from any <i>dwelling</i> on adjoining properties. All other requirements of the By-Law shall apply.
Not Available	RH-12	Notwithstanding the provisions of this By-Law to the contrary, within any area <i>zoned</i> RH-12 on Schedule "A" hereto, a <i>modular dwelling /mobile home</i> as a <i>single detached dwelling</i> may be used as the <i>main dwelling</i> . All other requirements of the By-Law shall apply.
Not Available	RH-13	Notwithstanding any provisions of this By-Law to the contrary, within any area <i>zoned</i> RH-13 on Schedule "A" hereto, in addition to the <i>uses</i> permitted in Residential Hamlet (RH) <i>Zone</i> , the parking of one <i>transport</i> truck including tractor and <i>trailer</i> shall also permitted. All other requirements of the By-Law shall apply.

SECTION 9: NON-URBAN RESIDENTIAL (NUR) ZONES

By-Law No.	Zone Code	Description
122-12	RH-14	Notwithstanding any provision of this By-Law to the contrary, within any area <i>zoned</i> RH-14 on Schedule "A" hereto, the minimum right (west) <i>side yard</i> shall be 30.0 metres and the <i>dwelling</i> shall have no more than one (1) habitable <i>storey</i> fully above <i>grade</i> . All other requirements of the By-Law shall apply.
4-16	RH-15	Notwithstanding any provision of this By-Law to the contrary, within any area <i>zoned</i> RH-15 on Schedule "A" hereto, a <i>rear yard setback</i> of 0.2 m for a detached <i>accessory structure existing</i> on the date of January 20, 2016 shall be permitted. All other requirements of the By-Law shall apply.
Not Available	RH-16	Notwithstanding anything in this By-Law to the contrary, within any area <i>zoned</i> RH-16 on Schedule "A" hereto, in addition to the uses permitted in the Residential Hamlet (RH) <i>Zone</i> , a <i>service shop</i> having a maximum <i>gross floor area</i> of 144 square metres shall also be permitted. All other requirements of the By-Law shall apply.

SECTION 9: NON-URBAN RESIDENTIAL (NUR) ZONES

9.5 Special Exceptions RR Zone

By-Law No.	Zone Code	Description
206-06	RR-1	Notwithstanding any provision of this By-Law to the contrary, within any area <i>zoned</i> RR-1 on Schedule “A” hereto, the minimum <i>front yard setback</i> shall be measured from Robinson Road and a <i>lot</i> shall be considered a <i>building lot</i> notwithstanding having no frontage within a <i>development Zone</i> . All other requirements of the By-Law shall apply.
203-07, 204-06, 73-09	RR-2	Notwithstanding any provision of this By-Law to the contrary, within any area <i>zoned</i> RR-2 on Schedule “A” hereto, the minimum <i>front yard</i> shall be 30.0 metres. All other requirements of the By-Law shall apply.
65-08, 240-06	RR-3	Notwithstanding any provision of this By-Law to the contrary, within any area <i>zoned</i> RR-3 on Schedule “A” hereto, the minimum <i>lot area</i> shall be 3,000 square metres and the minimum <i>floor area</i> for the <i>dwelling</i> unit shall be 205 square metres. All other requirements of the By-Law shall apply.
121-02	RR-4	Notwithstanding any provision of this By-Law to the contrary, within any area <i>zoned</i> RR-4 on Schedule "A" hereto, in addition to the <i>uses</i> permitted in the Rural Residential (RR) <i>Zone</i> , an agricultural feed establishment in an <i>existing building</i> or <i>structure</i> shall also be permitted. All other requirements of the By-Law shall apply.
Not Available	RR-5	Notwithstanding any provision of this By-Law to the contrary, within any area <i>zoned</i> RR-6 on Schedule "A" hereto, in addition to the <i>uses</i> permitted in the Rural Residential (RR) <i>Zone</i> , a <i>service shop</i> in an <i>existing building</i> or <i>structure</i> shall also be permitted. All other requirements of the By-Law shall apply.
121-02, 83-03	RR-6	Notwithstanding any provision of this By-Law to the contrary,, within any area <i>zoned</i> RR-6 on Schedule ‘A’ hereto, the minimum <i>lot frontage</i> shall be 35 metres and the minimum <i>interior side yard</i> shall be 3 metres. All other requirements of the By-Law shall apply.
141-03	RR-7	Notwithstanding any other provision of this By-Law to the contrary, within any area <i>zoned</i> RR-7 on Schedule “A” hereto, habitable space may be permitted in a cellar. All other requirements of the By-Law shall apply.
24-03, 158-03	RR-8	Notwithstanding any other provision of this By-Law to the contrary, within any area <i>zoned</i> RR-8 on Schedule ‘A’ hereto, the total maximum <i>floor area</i> of <i>accessory buildings</i> shall be 223 square metres and the maximum <i>height</i> of an <i>accessory building</i> shall be 7.3 metres. All other requirements of the By-Law shall apply.

SECTION 9: NON-URBAN RESIDENTIAL (NUR) ZONES

By-Law No.	Zone Code	Description
111-04	RR-9	Notwithstanding any provision of this By-Law to the contrary, within any area <i>zoned</i> RR-9 on Schedule “A” hereto, the total maximum <i>floor area</i> of <i>accessory buildings</i> shall be 330 square metres and the maximum <i>height</i> of one (1) <i>accessory building</i> shall be 6.1 metres. All other requirements of the By-Law shall apply.
188-04	RR-10	Notwithstanding any provision of this By-Law to the contrary, within any area <i>zoned</i> RR-10 on Schedule “A” hereto, the total maximum <i>floor area</i> of <i>accessory buildings</i> shall be 157 square metres and a maximum <i>height</i> of 6.6 metres shall be permitted. All other requirements of the By-Law shall apply.
161-10	RR-11	Notwithstanding any provision of this By-Law to the contrary, within any area <i>zoned</i> RR-11 on Schedule “A” hereto, the total maximum <i>floor area</i> of <i>accessory buildings</i> shall be 245 m ² . All other requirements of the By-Law shall apply.
84-10	RR-12	Notwithstanding any provision of this By-Law to the contrary, within any area <i>zoned</i> RR-12 on Schedule “A” hereto, the total maximum <i>floor area</i> of <i>accessory buildings</i> shall be 223 m ² and the maximum <i>height</i> of one (1) <i>accessory building</i> shall be 7.3 meters. All other requirements of the By-Law shall apply.
202-11	RR-13	Notwithstanding any provision of this By-Law to the contrary, within any area <i>zoned</i> RR-13 on Schedule “A” hereto, the total maximum <i>floor area</i> of <i>accessory buildings</i> shall be 320 square metres and a maximum <i>height</i> of 5.2 metres shall be permitted. All other requirements of the By-Law shall apply.
74-12	RR-14	Notwithstanding any provision of this By-Law to the contrary, within any area <i>zoned</i> RR-14 on Schedule “A” hereto, in addition to the <i>uses</i> permitted in the Rural Residential (RR) <i>Zone</i> , a facility for the boarding of a maximum of 58 domestic household cats (<i>Felis catus</i>) in an <i>existing</i> 98 square metre <i>building</i> shall also be permitted. All other requirements of the By-Law shall apply.
157-13	RR-15	Notwithstanding anything is this By-Law to the contrary, within any area <i>zoned</i> RR-15 on Schedule “A” hereto, no part of any <i>dwelling</i> shall be located closer than 117 metres to a <i>livestock facility</i> located at 24 McBay Road. All other requirements of the By-Law shall apply.
40-14	RR-16	Notwithstanding any provision of this By-Law to the contrary, within any area <i>zoned</i> RR-16 on Schedule “A” hereto, the minimum <i>front yard</i> shall be 10.0 metres. All other requirements of the By-Law shall apply.

SECTION 9: NON-URBAN RESIDENTIAL (NUR) ZONES

By-Law No.	Zone Code	Description
115-14	RR-17	Notwithstanding any provision of this By-Law to the contrary, within any area <i>zoned</i> RR-17 on Schedule “A” hereto, a deficient <i>lot area</i> of 0.32 ha and 0.25 ha shall be permitted. All other requirements of the By-Law shall apply.
Not Available	RR-18	Notwithstanding any provisions of this By-Law to the contrary, within any area <i>zoned</i> RR-18 on Schedule “A” hereto, the <i>lot frontage</i> shall be 50 metres, the <i>front yard</i> shall be 15 metres and the <i>exterior side yard</i> shall be 15 metres. The minimum ground <i>floor area</i> of <i>dwelling units</i> shall be 232.25 square metres for a one (1) <i>storey</i> or split level <i>structure</i> and 139.35 square metres for a <i>structure</i> one and a half (1 1/2) <i>storeys</i> or greater. Where no <i>basement</i> is provided, the minimum ground <i>floor area</i> shall be increased by 18.58 square metres. All other requirements of the By-Law shall apply.
180-03	RR-19	Notwithstanding any other provisions in this By-Law to the contrary, within any area <i>zoned</i> RR-19 on Schedule ‘A’ hereto, an <i>accessory building</i> a maximum <i>height</i> of 8.5 metres shall be permitted. All other requirements of the By-Law shall apply.
202-03	RR-20	Notwithstanding any provision in this By-Law to the contrary, within any area <i>zoned</i> RR-20 on Schedule ‘A’ hereto, the <i>front yard setback</i> shall be 60 metres. All other requirements of the By-Law shall apply.
168-05	RR-21	Notwithstanding any provision of this By-Law to the contrary, within any area <i>zoned</i> RR-21 on Schedule “A” hereto, an <i>accessory building</i> with a maximum <i>height</i> of 7.0 metres shall be permitted. The minimum <i>rear yard</i> , measured from the <i>top of bank</i> , shall be 15.0 metres. All other requirements of the By-Law shall apply.
82-06	RR-22	Notwithstanding any provision of this By-Law to the contrary, within any area <i>zoned</i> RR-22 on Schedule “A” hereto, an <i>accessory building</i> with a maximum <i>floor area</i> of 290 square metres shall be permitted and no more than one (1) <i>accessory building</i> shall be 8.9 metres in <i>height</i> provided that such <i>accessory building</i> is <i>setback</i> at least 10.0 metres from any <i>lot line</i> . All other requirements of the By-Law shall apply.

SECTION 9: NON-URBAN RESIDENTIAL (NUR) ZONES

By-Law No.	Zone Code	Description
150-06	RR-23	<p>Notwithstanding any provision of this By-Law to the contrary, within any area <i>zoned</i> RR-23 on Schedule “A” hereto, <i>development</i> may be permitted on the following basis:</p> <ul style="list-style-type: none"> a) The maximum number of <i>dwelling units</i> shall be eight (8). b) For the purpose of this By-Law, a <i>lot</i> is considered to be the land area which constitutes a unit of a <i>condominium</i> corporation. c) Individual <i>lots</i> do not require frontage on a <i>public street</i>. d) The minimum <i>lot area</i> shall be 4,000 square metres. e) The minimum <i>front yard and exterior side yard</i> shall be 10 meters. f) For the purpose of determining <i>lot area, lot coverage, landscaped area and development setbacks</i>, a <i>lot</i> does not include any portion of the common elements. g) <i>Lot area, lot frontage, development setbacks and yard configuration</i> shall be determined as if the common element road were a <i>public street</i>. h) No <i>building or structure</i>, including a swimming pool or any part of a sewage system, shall be permitted within 14.0 metres of Brant Road (Highway No. 24). <p>All other requirements of the By-Law shall apply.</p>
137-07	RR-24	<p>Notwithstanding any provision of this By-Law to the contrary, within any area <i>zoned</i> RR-24 on Schedule “A” hereto, the following provisions shall apply:</p> <ul style="list-style-type: none"> a) The minimum <i>lot frontage</i> shall be 36.0 metres at the northerly <i>lot line</i>. b) The <i>main building</i> must be <i>setback</i> at least 6.0 metres from the edge of water of Blue Lake and 6.0 metres from any <i>lot line</i>. c) The maximum <i>gross floor area</i> of all <i>accessory buildings</i>, including the <i>existing boat house</i> in its <i>existing</i> location, permitted shall be 163 square metres. <p>All other requirements of the By-Law shall apply.</p>
11-09	RR-25	<p>Notwithstanding any provision of this By-Law to the contrary, within any area <i>zoned</i> RR-25 on Schedule “A” hereto, an <i>existing one-storey accessory building</i> with a total <i>floor area</i> not exceeding 350 square metres shall be permitted.</p> <p>All other requirements of the By-Law shall apply.</p>

SECTION 9: NON-URBAN RESIDENTIAL (NUR) ZONES

By-Law No.	Zone Code	Description
76-13	RR-26	Notwithstanding any provision of this By-Law to the contrary, within any area <i>zoned</i> RR-26 on Schedule “A” hereto, the maximum <i>lot coverage</i> for all <i>accessory structures</i> shall not exceed 158m ² with a maximum <i>height</i> of 8.53 metres and may be located 24.0 metres from the <i>front lot line</i> . All other requirements of the By-Law shall apply.
97-13, 134-13	RR-27	Notwithstanding any provision of the By-Law to the contrary, within any area <i>zoned</i> RR-27 on Schedule “A” hereto, the minimum <i>front yard</i> shall be 40.0 metres. All other requirements of the By-Law shall apply.
162-13	RR-28	Notwithstanding any provision of this By-Law to the contrary, within any area <i>zoned</i> RR-28 on Schedule “A” hereto, the following shall apply; an increased <i>front yard setback</i> of 65m. All other requirements of the By-Law shall apply.
119-03	RR-29	Notwithstanding any provision of this By-Law to the contrary, within any area <i>zoned</i> RR-29 on Schedule ‘A’ hereto, following regulations shall apply: <ul style="list-style-type: none"> a) Minimum <i>Lot Area</i>: 1 hectare b) Minimum <i>Lot Frontage</i>: 60 meters c) Minimum <i>Front Yard</i>: 75 metres. All other requirements of the By-Law shall apply.
138-03, 139-03	RR-30	Notwithstanding any provision of this By-Law to the contrary, within any area <i>zoned</i> RR-30 on Schedule ‘A’ hereto, following regulations shall apply: <ul style="list-style-type: none"> a) Minimum <i>Lot Area</i>: 1 hectare b) Minimum <i>Lot Frontage</i>: 60 meters c) Minimum <i>Rear Yard</i>: 80 metres. All other requirements of the By-Law shall apply.
241-04	RR-31	Notwithstanding any provision of this By-Law to the contrary, within any area <i>zoned</i> RR-31 on Schedule ‘A’ hereto, following regulations shall apply: <ul style="list-style-type: none"> a) Minimum <i>Lot Area</i>: 1 hectare b) Minimum <i>Lot Frontage</i>: 60 meters c) Minimum <i>Front Yard</i>: 20 metres. All other requirements of the By-Law shall apply.
221-05	RR-32	Notwithstanding any provision of this By-Law to the contrary, within any area <i>zoned</i> RR-32 on Schedule “A” hereto, a <i>dwelling unit</i> shall not be permitted. All other requirements of the By-Law shall apply.

SECTION 9: NON-URBAN RESIDENTIAL (NUR) ZONES

By-Law No.	Zone Code	Description
162-08, 39-11	RR-33	Notwithstanding any provision of this By-Law to the contrary, within any area <i>zoned</i> RR-33 on Schedule 'A' hereto, following regulations shall apply: <ul style="list-style-type: none"> a) Minimum <i>Lot Area</i>: 1 hectare b) Minimum <i>Lot Frontage</i>: 50 meters All other requirements of the By-Law shall apply.
7-10, 118-03, 120-03, 119-03, 114-03, 221-05, 231-07	RR-34	Notwithstanding any provision of this By-Law to the contrary, within any area <i>zoned</i> RR-34 on Schedule 'A' hereto, following regulations shall apply: <ul style="list-style-type: none"> a) Minimum <i>Lot Area</i>: 1 hectare b) Minimum <i>Lot Frontage</i>: 60 meters c) Minimum <i>Street Setback</i>: 25 metres. d) Minimum <i>Interior Side Yard Setback</i>: 6 meters e) Minimum <i>Rear Yard Setback</i>: 15 meters All other requirements of the By-Law shall apply.
6-10	RR-35	Notwithstanding any provision of this By-Law to the contrary, within any area <i>zoned</i> RR-35 on Schedule "A" hereto, in addition to the <i>uses</i> permitted in the Rural Residential (RR) <i>Zone</i> , a <i>converted dwelling</i> shall be a permitted <i>use</i> . All other requirements of the By-Law shall apply.
225-10	RR-36	Notwithstanding any provision of this By-Law to the contrary, within any area <i>zoned</i> RR-36 on Schedule "A" hereto, the minimum <i>lot frontage</i> shall be 12.0 metres. All other requirements of the By-Law shall apply.
118-15	RR-37	Notwithstanding any provision of this By-Law to the contrary, within any area <i>zoned</i> RR-37 on Schedule "A" hereto, an <i>accessory structure</i> with a maximum <i>height</i> of 7.0 meters, maximum <i>gross floor area</i> of 450 m ² , for the purposes of storing up to 4 <i>commercial vehicles</i> and upto 4 construction <i>vehicles/equipment</i> shall be permitted. All other requirements of the By-Law shall apply.

SECTION 10: COMMERCIAL (C) ZONES

10.1 Uses Permitted

No person shall within any Commercial (C) Zones, use any lot or erect, alter or use any building or structure for any purpose except for one or more of the following uses as identified by a “dot”.

The Commercial Zones established by this By-Law are as follows:

C1	Neighbourhood Commercial
C2	General Commercial
C3	Shopping Centre Commercial
C4	Core Area Commercial
C5	Mixed Use Commercial
C6	Automotive Commercial

Table 10.1: Uses Permitted

List of Uses	Zones					
	C1	C2	C3	C4	C5	C6
<i>Accessory Dwelling (in accordance with Section 10.3)</i>				•	•	
<i>Art Gallery</i>			•	•	•	
<i>Assembly Hall</i>		•		•		
<i>Auditorium</i>		•	•	•		
<i>Automobile Repair Garage</i>		•				•
<i>Automobile Sales or Rental Establishment</i>		•				•
<i>Automobile Service Station</i>		•				•
<i>Bakery</i>		•	•	•	•	
<i>Bulk Sales Establishment</i>		•	•			
<i>Car Wash</i>		•				•
<i>Commercial Parking Lot</i>				•		
<i>Convenience Store</i>	•	•	•	•	•	
<i>Day Care</i>	•	•	•	•	•	
<i>Drive-Through Facility</i>		•	•			

SECTION 10: COMMERCIAL (C) ZONES

List of Uses	Zones					
	C1	C2	C3	C4	C5	C6
<i>Dry Cleaning and Laundromat</i>	•	•	•	•		
<i>Financial Institution</i>	• ¹	•	•	•		
<i>Florist Shop</i>	•	•	•	•	•	
<i>Funeral Home</i>		•				
<i>Grocery Store</i>		•	•	• ²	• ²	
<i>Home Improvement Centre</i>		•				
<i>Hotel</i>		•	•	•		
<i>Museum</i>	•		•	•		
<i>Nursery and Garden Centre</i>		•	•			
<i>Office, Business/Professional</i>	•	•	•	•	•	
<i>Office, Medical</i>		•	•	•		
<i>Office Supply Outlet</i>		•	•			
<i>Personal Service Establishment</i>	•	•	•	•	•	
<i>Pharmacy</i>	• ³	•	•	•	• ³	
<i>Recreational Establishment</i>		•	•	•		
<i>Restaurant</i>		•	•	•	•	
<i>Retail Store</i>	•	•	•	•	•	
<i>School, Commercial</i>		•	•	•	•	
<i>Service and Rental Establishment</i>		•				•
<i>Shipping Container in accordance with Section 4.35</i>		•			•	
<i>Studio</i>	•		•	•	•	
<i>Taxi Stand</i>		•		•		
<i>Veterinary Clinic</i>		•	•			

1 The maximum area for a Financial Institution in a C1 Zone shall not exceed 250 sq. m.

2 The maximum area for a grocery store in a C4 or C5 Zone shall not exceed 500 sq. m.

3 The maximum area for a Pharmacy in a C1 or C5 Zone shall not exceed 250 sq. m.

10.2 Zone Requirements

SECTION 10: COMMERCIAL (C) ZONES

No person shall within any Commercial (C) Zones, use any lot or erect, alter or use any building or structure except in accordance with the following provisions:

Table 10.2: Zone Provisions

Provisions	Specifications					
	C1	C2	C3	C4	C5	C6
Lot Area , Minimum (sq. m)	1000	1000	1000	Nil	1000	3000
Lot Frontage , Minimum (metres)	15	15	30	15	15.0	15
Street Setback , Minimum (metres)	6.0	6.0	6.0	Nil	6.0	15
Interior Side Yard Setback , Minimum (metres)	3.0	3.0	3.0	Nil	3.0	7.5
-Yard abutting Residential or Institutional Zone	3.0	7.5	7.5	3.0	7.5	15
Rear Yard Setback , Minimum (metres)	6.0	3.0	3.0	Nil	3.0	7.5
-Yard abutting Residential or Institutional Zone	3.0	7.5	7.5	3.0	7.5	15
Lot Coverage , Maximum	60%	60%	60%	Nil	60%	40%
Landscaped Open Space , Minimum	10%	10%	10%	Nil	20%	30%
Building Height , Maximum (metres)	10.0	12.0	15.0	15.0	10.0	10.0
Commercial Floor Area , Maximum (sq. m)	500	-	-	2500	-	

1. No Minimum rear yard requirement for properties on Grand River or Nith River

10.3 Regulations for Accessory Dwellings

- a) An accessory dwelling shall only be permitted in a Commercial Zone if it is incidental to the permitted commercial use and shall not be located in combination with one or more of the following uses:

SECTION 10: COMMERCIAL (C) ZONES

- (i) *Automotive use*
 - (ii) *Dry cleaning and laundromat*
 - (iii) *Taxi stand*
 - (iv) *Service and rental establishment*
 - (v) *Drive-through facility*
- b) The *accessory dwelling* shall be located in the same *building* and above the *ground floor* level as the permitted commercial use(s) except that an *accessory dwelling* may be located on the *ground floor* of a motel or *hotel*.
- c) The *accessory dwelling* shall have a separate *private* entrance from the outside or a common hallway.
- d) The *gross residential floor area* of the *building* does not constitute more than two-thirds of the total *gross floor area* of the *building*.
- e) Parking for the *accessory dwelling* shall be provided on the same *lot* in addition to the *parking spaces* required for the *main use* in accordance with Section 5.11 of the By-Law.

10.4 Regulations for Existing Dwellings

Notwithstanding any other provisions of this section, where in any Commercial Zone a *legally existing dwelling unit* shall deem to conform the requirements of this By-Law. Any additions, extensions, rebuilding or repair to such *dwelling* shall be permitted provided it meets the Zone regulations as if it is located in any Residential Zone.

Home occupation shall be permitted in the *existing dwellings* in accordance with the provisions of this By-Law.

Any *accessory uses, buildings or structures* shall be permitted as if it is located in any Residential Zone and shall comply with the General Provisions Section 4 of this By-Law.

10.5 Yard Requirement - Fuel Dispensing

Notwithstanding provisions of Table 10.2 above, where the sale of *vehicle* fuels is a permitted *use*, the street setback for fuel pumps and a *fuel pump island* shall be 3.0 metres.

10.6 Outdoor Retail Display

An outdoor retail display area permitted shall be permitted in any Commercial Zone *accessory* to the *main use*, provided the following requirements are met:

SECTION 10: COMMERCIAL (C) ZONES

- a) The outdoor retail display shall only be permitted in C2, C3 and C6 Zone;
- b) The outdoor retail display shall not be located on the *road allowance*;
- c) The outdoor retail display area shall not be located within any required *yard*, required parking and/or loading areas or any required *landscaped open space* of the Zone; and,
- d) The outdoor retail display shall not obstruct pedestrian and vehicular traffic;
- e) The outdoor retail display area shall be located no closer than 15.0 metres to any Residential Zone.
- f) Additional parking shall be provided for the outdoor retail display in accordance with the provisions of this By-Law.

10.7 Special Exceptions C1 Zone

By-Law No.	Zone Code	Description
Not Available	C1-1	Notwithstanding any provisions of this By-Law to the contrary, within any area <i>zoned</i> C1-1 on Schedule "A" hereto, the permitted <i>uses</i> shall be limited to a dental office with a minimum <i>side yard</i> of 0.6 metres. All other requirements of the By-Law shall apply.
Not Available	C1-2	Notwithstanding any provisions of this By-Law to the contrary, within any area <i>zoned</i> C1-2 on Schedule "A" hereto, in addition to the <i>uses</i> permitted in the Neighbourhood Commercial (C1) Zone, a <i>restaurant</i> and a <i>printing establishment</i> shall also be permitted. Furthermore, no minimum <i>front yard</i> shall be required and the maximum <i>lot coverage</i> shall be 35%. All other requirements of the By-Law shall apply.
Not Available	C1-3	Notwithstanding any provision of this By-Law to the contrary, within any area <i>zoned</i> C1-3 on Schedule "A", hereto, parking may be provided at a rate of one (1) parking space for every 25 square metres of <i>building</i> , the minimum required <i>front yard</i> shall be 5.6 metres and one (1) <i>accessory dwelling</i> unit shall also be permitted. All other requirements of the By-Law shall apply.
Not Available	C1-4	Notwithstanding any provisions of this By-Law to the contrary, within any area <i>zoned</i> C1-4 on Schedule "A" hereto, the permitted <i>uses</i> shall be limited to a beer store. All other requirements of the By-Law shall apply.

SECTION 10: COMMERCIAL (C) ZONES

By-Law No.	Zone Code	Description
Not Available	C1-5	Notwithstanding any provision of this By-Law to the contrary, within any area <i>zoned</i> C1-5 on Schedule "A" in addition to the <i>uses</i> permitted in the Neighbourhood Commercial (C1) Zone, a <i>brewing on premises establishment</i> which may include an <i>accessory restaurant</i> to a total of 50 square metres and the studio of home decorating consultant/interior designer with an secondary retail component may also be permitted. All other requirements of the By-Law shall apply.
Not Available	C1-6	Notwithstanding any provision of this By-Law to the contrary, within any area <i>zoned</i> C1-6 on Schedule "A" hereto, in addition to the <i>uses</i> permitted in the C1 Zone, an <i>automobile repair garage</i> and sales establishment shall be a permitted <i>use</i> . All other requirements of the By-Law shall apply.
Not Available	C1-7	Notwithstanding any provision of this By-Law to the contrary, within any area <i>zoned</i> C1-7 on Schedule "A" hereto, in addition to the <i>uses</i> permitted in the C1 Zone, an automobile storage area totally within a fenced compound shall also be permitted. All other requirements of the By-Law shall apply.
Not Available	C1-8	Notwithstanding any provisions of this By-Law to the contrary, within any area <i>zoned</i> C1-8 on Schedule "A" hereto, the permitted <i>uses</i> shall be limited to a <i>retail store</i> , an <i>accessory dwelling</i> located on the second or third floor and <i>uses accessory</i> to the foregoing. All other requirements of the By-Law shall apply.
Not Available	C1-9	Notwithstanding any provisions of this By-Law to the contrary, within any area <i>zoned</i> C1-9 on Schedule "A" hereto, the permitted <i>uses</i> shall be limited to a gift shop/antique store and one <i>accessory dwelling</i> unit. All other requirements of the By-Law shall apply.

SECTION 10: COMMERCIAL (C) ZONES

By-Law No.	Zone Code	Description
Not Available	C1-10	<p>Notwithstanding any provisions of this By-Law to the contrary, within any area zoned C1-10 on Schedule "A" hereto the permitted uses shall be limited to:</p> <ul style="list-style-type: none"> a) an <i>accessory dwelling unit</i>; b) a bank; c) a <i>business or professional office</i>; d) a <i>medical office</i>; e) a <i>day care</i>; f) a gas bar; g) a service shop; h) a <i>personal service establishment</i>; i) a pet grooming shop, not including the breeding, raising or boarding of animals, a <i>veterinary clinic</i> or a <i>kennel</i>; j) a <i>private club</i>; k) a refreshment room, l) a <i>restaurant</i>, m) a <i>retail store</i>; n) an <i>accessory use</i>. <p>All other requirements of the By-Law shall apply.</p>
Not Available	C1-11	<p>Notwithstanding any provisions of this By-Law to the contrary, within any area zoned C1-11 on Schedule "A" hereto, the permitted uses shall be limited to</p> <ul style="list-style-type: none"> a) a <i>business or professional office</i>, b) a <i>studio</i>, c) a <i>warehouse</i>, d) an <i>accessory workshop</i>, e) <i>accessory</i> photographic processing room and a <i>parking lot</i>. <p>The following provisions shall also apply:</p> <ul style="list-style-type: none"> a) Minimum <i>Lot Area</i> - 1828 square metres; b) Minimum <i>Lot Frontage</i> - 29.8 metres; c) Minimum <i>Lot Depth</i> - 61 metres; d) Minimum <i>Front Yard</i> - 3 metres; e) Minimum <i>Interior Side Yard</i> - 0.8 metres; f) Minimum <i>Exterior Side Yard</i> - 5.5 metres; g) Minimum <i>Rear Yard</i> - 7.5 metres; h) Minimum <i>Landscaped Open Space</i> - 15%; i) Maximum <i>Lot Coverage</i> - 50%; j) Maximum <i>Building Height</i> - 9 metres; k) Minimum 10 <i>parking spaces</i> are required for the <i>studio</i> and <i>accessory uses</i>. <p>Any other uses are required to provide parking in accordance with Section 5. Furthermore, no outside storage is permitted and all signage shall be non-internally illuminated. All other requirements of the By-Law shall apply.</p>

SECTION 10: COMMERCIAL (C) ZONES

By-Law No.	Zone Code	Description
Not Available	C1-12	Notwithstanding any provisions of this By-Law to the contrary, within any area <i>zoned</i> C1-12 on Schedule "A" hereto, in addition to the <i>uses</i> permitted in Neighbourhood Commercial (C1) Zone, a nursery school and a residential <i>dwelling unit</i> that is not <i>accessory</i> to the commercial <i>use</i> shall also be permitted. However, the <i>dwelling unit</i> must have a minimum <i>floor area</i> of 46.5 square metres. All other requirements of the By-Law shall apply.
Not Available	C1-13	Notwithstanding any provisions of this By-Law to the contrary, within any area <i>zoned</i> C1-13 on Schedule "A" hereto, the <i>uses</i> shall be limited to: <ul style="list-style-type: none"> a) a dental office; b) a <i>business or professional office</i>; c) a coffee shop; d) a <i>retail store</i>; e) a <i>service shop</i>; f) a tradesman shop with no outside storage; g) a <i>warehouse</i>; h) a <i>wholesale establishment</i>; i) <i>dwelling units</i> restricted to above the first floor; A minimum of 40 <i>parking spaces</i> shall be provided on the <i>lot</i> . All other requirements of the By-Law shall apply.
Not Available	C1-14	Notwithstanding any provisions of this By-Law to the contrary, within any area <i>zoned</i> C1-14 on Schedule "A" hereto, the following regulations shall apply: <ul style="list-style-type: none"> a) minimum <i>front yard setback</i> -12 metres; b) minimum <i>exterior side yard</i> - 6 metres; c) maximum number of residential <i>uses</i> - 1 <i>dwelling unit</i>; d) minimum <i>gross floor area</i> of <i>dwelling unit</i> - 90 sq. mt.; e) maximum <i>gross floor area</i> of <i>dwelling unit</i> - 110 sq. mt. Furthermore, no commercial <i>use</i> shall be permitted on the lands unless it is a recognized low volume water user with respect to both water consumption and discharge. All other requirements of the By-Law shall apply.

SECTION 10: COMMERCIAL (C) ZONES

By-Law No.	Zone Code	Description
Not Available	C1-15	<p>Notwithstanding any provisions of this By-Law to the contrary, within any area <i>zoned</i> C1-15 on Schedule "A" hereto, <i>uses</i> shall be restricted to a <i>private garage</i> and storage <i>uses accessory</i> to the <i>main</i> commercial and residential <i>uses</i>.</p> <p>Furthermore, no outside storage shall be permitted.</p> <p>The <i>building height</i> shall not exceed 4.5 metres.</p> <p>The <i>gross floor area</i> of the commercial <i>use</i> shall not exceed 114 square metres. The minimum <i>yard setback</i> from Cuning Street and from Malcolm Street shall be 6.0 metres, and the minimum <i>interior side yard</i> shall be 1.8 metres.</p> <p>All other requirements of the By-Law shall apply.</p>
83-15	C1-16	<p>Notwithstanding any provisions of this By-Law to the contrary, within any area <i>zoned</i> C1-16 on Schedule "A" hereto, the <i>uses</i> shall be limited to;</p> <ul style="list-style-type: none"> a) <i>business or professional office</i>; b) a tradesman shop with no outside storage; c) a <i>single detached dwelling accessory</i> to a permitted <i>use</i>; d) an additional <i>dwelling unit</i> located within the <i>single detached dwelling</i>. <p>The <i>Zone</i> requirements shall be as follows;</p> <ul style="list-style-type: none"> a) Minimum <i>Lot Area</i> - 1,300m²; b) Minimum <i>Lot Frontage</i> - 25m; c) Minimum <i>Interior Side Yard</i> - 3.0m; d) Minimum <i>Interior Side Yard or Rear Yard setback</i> of 1.0m for the <i>existing accessory structure</i>. <p>All other requirements of the By-Law shall apply.</p>

SECTION 10: COMMERCIAL (C) ZONES

By-Law No.	Zone Code	Description
212-02 172-15	C1-17	<p>Notwithstanding any provision of this By-Law to the contrary, within any area zoned C1-17 on Schedule "A" hereto, the <i>uses</i> shall be limited to the following:</p> <ul style="list-style-type: none"> a) <i>Art gallery;</i> b) <i>Bakery</i> c) <i>Car sales outlet for a maximum of 12 vehicles, with no repairs onsite;</i> d) <i>Daycare;</i> e) <i>Dry cleaning and laundromat;</i> f) <i>Dwelling units;</i> g) <i>Financial institution;</i> h) <i>Florist shop;</i> i) <i>Grocery Store/Supermarket;</i> j) <i>Nursery and Garden Centre;</i> k) <i>Home Improvement Centre;</i> l) <i>Museum;</i> m) <i>Office, Business or Professional;</i> n) <i>Office, Medical/Dental;</i> o) <i>Parking Lot;</i> p) <i>Personal Service Establishment;</i> q) <i>Pharmacy;</i> r) <i>Printing Establishment;</i> s) <i>Service and Rental Establishment;</i> t) <i>Restaurant;</i> u) <i>Retail Store;</i> v) <i>Studio;</i> w) <i>Veterinary Clinic;</i> x) <i>Wholesale establishment accessory to permitted uses;</i> y) <i>Any existing automotive use;</i> z) <i>Any existing dwelling unit;</i> <p>A 0.9 metre <i>planting strip</i> shall be required along the easterly <i>lot line</i>, which shall contain an opaque fence, in accordance with the requirements of Section 4(18) of the By-Law. No <i>planting strip</i> shall be required along the southerly <i>lot line</i>. All other requirements of the By-Law shall apply.</p>

SECTION 10: COMMERCIAL (C) ZONES

By-Law No.	Zone Code	Description
174-14	C1-18	<p>Notwithstanding any provision of this By-Law to the contrary, within any area <i>zoned</i> C1-18 on Schedule “A” hereto, in addition to the <i>uses</i> permitted in Neighbourhood Commercial (C1) <i>Zone</i>, accessory <i>dwelling units</i> shall be permitted above ground floor commercial uses.</p> <p>All <i>uses</i> shall be subject to the following <i>zone</i> requirements:</p> <ul style="list-style-type: none">a) Maximum <i>Gross Floor Area</i>: 500 square metres for the total of all commercial uses.b) Minimum <i>Interior Side Yard Setback</i>: 3.0 metres per storey to a maximum of 12 metres.c) Minimum <i>Exterior Side Yard Setback</i>: 6.0 metresd) Maximum <i>Lot Coverage</i>: 40% <p>All other requirements of the By-Law shall apply.</p>

SECTION 10: COMMERCIAL (C) ZONES

10.8 Special Exceptions C2 Zone

By-Law No.	Zone Code	Description
Not Available	C2-1	Notwithstanding any provisions of this By-Law to the contrary, within any area zoned C2-1 on Schedule "A" hereto, in addition to the uses permitted in the General Commercial (C2) Zone, a <i>retail store</i> limited in size to the <i>floor area</i> which existed on June 21, 1988, the parking and storage of camper <i>trailers</i> and the fabrication of knives and laundry hampers shall also be permitted. However, the total <i>floor area</i> of the fabrication operation shall not exceed 92.9 square metres. All other requirements of the By-Law shall apply.
Not Available	C2-2	Notwithstanding any provisions of this By-Law to the contrary, within any area zoned C2-2 on Schedule "A" hereto, in addition to the uses permitted in the General Commercial (C2) Zone, an <i>abattoir</i> , a <i>retail store</i> having a maximum <i>gross floor area</i> of 557.4 square metres, a <i>single detached dwelling</i> and a <i>dwelling unit</i> located on the second floor of the commercial business shall also be permitted. All other requirements of the By-Law shall apply.
95-05	C2-3	Notwithstanding any provisions of this By-Law to the contrary, within any area zoned C2-3 on Schedule "A" hereto, an <i>eating establishment</i> or a <i>restaurant</i> shall not be permitted. All other requirements of the By-Law shall apply.
Not Available	C2-4	Notwithstanding any provisions of this By-Law to the contrary, within any area zoned C2-4 on Schedule "A" hereto, <i>automotive uses</i> and underground storage tank shall not be permitted. Minimum required <i>parking space</i> width may also be reduced to 2.75 metres. All other requirements of the By-Law shall apply.
Not Available	C2-5	Notwithstanding any provisions of this By-Law to the contrary, within any area zoned C2-5 on Schedule "A" hereto, in addition to the uses permitted in the General Commercial (C2) Zone, an <i>auto body shop</i> and a <i>vehicle salvage yard</i> shall also be permitted. All other requirements of the By-Law shall apply.

SECTION 10: COMMERCIAL (C) ZONES

By-Law No.	Zone Code	Description
Not Available	C2-6	Notwithstanding any provisions of this By-Law to the contrary, within any area <i>zoned</i> C2-6 on Schedule "A" hereto, in addition to the <i>uses</i> permitted in the General Commercial (C2) Zone, a body shop limited to a maximum <i>lot coverage</i> of 10% of the <i>lot area</i> shall also be permitted. Furthermore, a solid painted metal or painted wood construction privacy fence, having a minimum <i>height</i> of 2 metres is required to be <i>erected</i> on the easterly, northerly and westerly perimeters of the subject lands. All other requirements of the By-Law shall apply.
Not Available	C2-7	Notwithstanding any provisions of this By-Law to the contrary, within any area <i>zoned</i> C2-7 on Schedule "A" hereto, in addition to the <i>uses</i> permitted in the General Commercial (C2) Zone, a <i>transport/truck terminal</i> and a <i>warehouse</i> shall also be permitted. All other requirements of the By-Law shall apply.
Not Available	C2-8	Notwithstanding any provisions of this By-Law to the contrary, within any area <i>zoned</i> C2-8 on Schedule "A" hereto, in addition to the <i>uses</i> permitted in the General Commercial (C2) Zone, the fabrication, manufacturing and retailing of boilers and an <i>automobile repair garage</i> shall also be permitted. All other requirements of the By-Law shall apply.
Not Available	C2-9	Notwithstanding any provisions of this By-Law to the contrary, within any area <i>zoned</i> C2-9 on Schedule "A" hereto, in addition to the <i>uses</i> permitted in the General Commercial (C2) Zone, a <i>public self-storage warehouse</i> and the light manufacturing of steel overhead garage doors shall also be permitted. All other requirements of the By-Law shall apply.
Not Available	C2-10	Notwithstanding any provisions of this By-Law to the contrary, within any area <i>zoned</i> C2-10 on Schedule "A" hereto, in addition to the <i>uses</i> permitted in the General Commercial (C2) Zone, an agricultural related commercial <i>use</i> and <i>accessory uses, buildings and structures</i> shall also be permitted. All other requirements of the By-Law shall apply.

SECTION 10: COMMERCIAL (C) ZONES

By-Law No.	Zone Code	Description
Not Available	C2-11	Notwithstanding any provisions of this By-Law to the contrary, within any area <i>zoned</i> C2-11 on Schedule "A" hereto the permitted <i>uses</i> shall be limited to: <ul style="list-style-type: none"> a) an <i>automotive use</i> excluding an <i>auto body shop</i>; b) <i>recreational vehicle</i> and <i>trailer service shop</i>; c) a drive-through, fast food or take-out <i>restaurant</i>; d) a <i>retail store accessory</i> to an <i>automotive use</i>; and e) a <i>convenience store</i>. All other requirements of the By-Law shall apply.
Not Available	C2-12	Notwithstanding any provisions of this By-Law to the contrary, within any area <i>zoned</i> C2-12 on Schedule "A" hereto, in addition to the <i>uses</i> permitted in the General Commercial (C2) <i>Zone</i> , a body shop shall also be permitted. All other requirements of the By-Law shall apply.
187-02	C2-13	Notwithstanding any provisions of this By-Law to the contrary, within any area <i>zoned</i> C2-13 on Schedule 'A' hereto, the following regulations will apply: <ul style="list-style-type: none"> a) <i>Front Yard</i> minimum: 5.3 m b) <i>Rear Yard</i> minimum: 25.0 m c) <i>Interior Side Yard</i> minimum: 6.5 m d) <i>Exterior Side Yard</i> minimum: 6.4 m e) <i>Required Parking Spaces</i>: 5 For the purpose of this By-Law, the <i>lot frontage</i> is defined as the Hanlon Street frontage. All other requirements of the By-Law shall apply.
189-02, 91-13	C2-14	Notwithstanding any provisions of this By-Law to the contrary, within any area <i>zoned</i> C2-14 on Schedule 'A' hereto, a <i>dwelling unit</i> is a permitted <i>use</i> , the minimum <i>interior side yard</i> for a <i>dwelling unit</i> shall be 3 metres. All other requirements of the By-Law shall apply.
161-03	C2-15	Notwithstanding any provisions of this By-Law to the contrary, within any area <i>zoned</i> C2-15 on Schedule 'A' hereto, a <i>salvage yard</i> associated with an auto-body shop shall be a permitted <i>use</i> . All other requirements of the By-Law shall apply.
212-03, 245-03 101-02, 163-10	C2-16	Notwithstanding any provisions of this By-Law to the contrary, within any area <i>zoned</i> C2-16 on Schedule 'A' hereto, a <i>contractor's yard</i> and associated storage of equipment and materials shall also be permitted. All other requirements of the By-Law shall apply.

SECTION 10: COMMERCIAL (C) ZONES

By-Law No.	Zone Code	Description
110-04	C2-17	<p>Notwithstanding any provision of this By-Law to the contrary, within any area zoned C2-17 on Schedule “A” hereto, the permitted <i>uses</i> shall be limited to <i>automobile sales or rental establishment</i> and the following regulations shall apply:</p> <ul style="list-style-type: none"> a) No more than ten (10) <i>vehicles</i> shall be displayed or stored on the <i>lot</i> at any time. b) The minimum <i>planting strip</i> adjacent to the <i>rear lot line</i> shall be 1.5 m. c) No <i>landscaped open space</i> shall be required in the <i>front yard</i> except for a minimum of 3m adjacent to the <i>west lot line</i> and a minimum of 1.5m adjacent to the <i>east lot line</i>. b) Minimum <i>Lot Area</i> 575m² c) Minimum <i>Lot Frontage</i> 20m d) Minimum <i>Front Yard Setback</i> 12m e) Minimum <i>Interior Side Yard Setback</i> 7m f) Minimum <i>Rear Yard Setback</i> 1.5m g) Maximum <i>Lot Coverage</i> 10% <p>All other requirements of the By-Law shall apply.</p>
243-04	C2-18	<p>Notwithstanding any provision of this By-Law to the contrary, within any area zoned C2-18 on Schedule “A” hereto, in addition to the <i>uses</i> permitted in the General Commercial (C2) the following shall be permitted <i>uses</i>:</p> <ul style="list-style-type: none"> a) an <i>agricultural equipment sales and service establishment</i>, b) a <i>building supply outlet</i>; c) a <i>contractor’s yard</i>; d) a <i>machine shop</i>; e) <i>tradesman’s shop</i>, and f) a <i>warehouse</i>. <p>All other requirements of the By-Law shall apply.</p>
41-06	C2-19	<p>Notwithstanding any provision of this By-Law to the contrary, within any area zoned C2-19 on Schedule “A” hereto, the <i>east interior side yard</i> shall be 1.5 metres and the <i>rear yard</i> shall be 3.8 metres. All other requirements of the By-Law shall apply.</p>
67-06	C2-20	<p>Notwithstanding any provision of this By-Law to the contrary, within any area zoned C2-20 on Schedule “A” hereto, the minimum left (north) <i>side yard</i> shall be 2.6 metres and the minimum <i>rear yard</i> shall be 4.6 metres. All other requirements of the By-Law shall apply.</p>

SECTION 10: COMMERCIAL (C) ZONES

By-Law No.	Zone Code	Description
38-07	C2-21	<p>Notwithstanding any provision of this By-Law to the contrary, within any area zoned C2-21 on Schedule “A” hereto, the uses permitted shall be limited to:</p> <ul style="list-style-type: none"> a) an <i>existing dwelling</i> and uses accessory thereto; b) an <i>existing contractor’s yard</i> including materials, equipment, and <i>vehicle</i> storage and <i>accessory uses, buildings and structures</i> totalling 440 square metres in <i>floor area</i>; c) a mobile shipping container, <i>public self-storage warehouse</i>, which for the purposes of this By-Law shall be stated as: <ul style="list-style-type: none"> i. a fenced compound of 1750 sq. mt. in area, containing not more than 40 mobile shipping containers, which do not exceed an individual cubic dimension of 3.1m X 16.2m X 3.1m, where individual storage containers are made available to the public for the storage or keeping of goods. ii. Where the containers are to be placed on <i>grade</i> and are not permitted to be stacked one on top of the other. iii. A <i>parking lot</i> of 1,225 square metres area associated with the <i>public self-storage warehouse</i>. iv. An office trailer not exceeding area of 38 sq. m associated with the <i>public self-storage warehouse</i>. d) a seasonal <i>nursery and garden centre use</i>, consisting of a temporary tent/awning <i>structure</i>, operating from March 1 to October 1 of any given year, and not to exceed an area of 279 sq. m. The <i>structures</i> are to be dismantled shortly thereafter the October 1 season is over. <p>All other requirements of the By-Law shall apply.</p>
136-07	C2-22	<p>Notwithstanding any provision of this By-Law to the contrary, within any area zoned C2-22 on Schedule “A” hereto, the following <i>development</i> standards shall apply:</p> <ul style="list-style-type: none"> a) for the <i>building</i>, the minimum interior right (east) <i>side yard</i> shall be 8.2 m. and the minimum <i>rear yard</i> shall be 1.5 m, b) for gas pump canopy, the minimum interior right (east) <i>side yard</i> shall be 3.2 m and the minimum <i>front yard</i> shall be 1.3 m. <p>All other requirements of the By-Law shall apply.</p>
105-08	C2-23	<p>Notwithstanding any provision of this By-Law to the contrary, within any area zoned C2-23 on Schedule “A” hereto, an <i>outdoor patio</i> associated with a <i>restaurant</i> may be located in the left (south) <i>side yard</i> adjacent to Powerline Road. The required number of <i>parking areas</i> shall be 76. Furthermore, a <i>single detached dwelling</i> shall be permitted and said <i>dwelling</i> shall be subject to the provisions of the Rural Residential (RR) Zone. All other requirements of the By-Law shall apply.</p>

SECTION 10: COMMERCIAL (C) ZONES

By-Law No.	Zone Code	Description
186-10	C2-24	<p>Notwithstanding any provision of this By-Law to the contrary, within any area zoned C2-24 on Schedule "A" hereto, the uses shall be limited to the following:</p> <ul style="list-style-type: none"> a. <i>assembly hall;</i> b. <i>automobile service station;</i> c. <i>automotive use;</i> d. <i>convenience store</i> to a maximum of 300 sq.m; e. <i>dry cleaner's distribution station;</i> f. <i>dry cleaning establishment;</i> g. <i>duplicating shop;</i> h. <i>dwelling unit accessory</i> to the permitted use excluding an <i>automotive use;</i> i. <i>florist shop;</i> j. <i>funeral home;</i> k. <i>hotel;</i> l. <i>liquor, beer and wine store</i> to a maximum of 372 sq. m; m. <i>medical office;</i> n. <i>nursery and garden centre;</i> o. <i>office, business or professional;</i> p. <i>office, service;</i> q. <i>personal service establishment;</i> r. <i>place of worship;</i> s. <i>printing establishment;</i> t. <i>recreational establishment;</i> u. <i>repair and rental establishment;</i> v. <i>restaurant;</i> w. <i>restaurant, drive-through or fast-food;</i> x. <i>retail store</i> with maximum <i>leasable floor area</i> of 800 sq. mt.; y. <i>veterinary clinic;</i> z. <i>video rental establishment;</i> aa. <i>an existing dwelling unit.</i> <p>All other requirements of the By-Law shall apply.</p>

SECTION 10: COMMERCIAL (C) ZONES

By-Law No.	Zone Code	Description
38-12	C2-25	<p>Notwithstanding anything in this By-Law to the contrary within an area zoned C2-25 on Schedule "A" the uses shall be limited to the following:</p> <ul style="list-style-type: none"> a) <i>automobile service station;</i> b) <i>automotive use;</i> c) <i>bulk sales establishment;</i> d) <i>convenience store;</i> e) <i>dwelling unit accessory to a permitted use excluding an automotive use;</i> f) <i>food store;</i> g) <i>home improvement centre;</i> h) <i>hotel;</i> i) <i>liquor, beer and wine store;</i> j) <i>nursery and garden centre;</i> k) <i>office supply outlet;</i> l) <i>personal service establishment;</i> m) <i>place of worship;</i> n) <i>recreational establishment;</i> o) <i>repair and rental establishment;</i> p) <i>restaurant;</i> q) <i>restaurant, drive-through or fast-food;</i> r) <i>retail store;</i> s) <i>veterinary clinic</i> t) <i>an existing dwelling unit.</i> <p>Furthermore, no <i>building, structure, parking area, access, outside storage or signage</i> shall be located within 14.0 metres of Highway No. 24.</p> <p>All other requirements of the By-Law shall apply.</p>
158-12, 95-13, 44-14	C2-26	<p>Notwithstanding any provision of this By-Law to the contrary, within any area zoned C2-26 on Schedule "A" hereto, in addition to the uses permitted in the C2 Zone, a <i>pharmacy</i> shall be a permitted use and the minimum <i>rear yard</i> shall be 3.0 metres. All other requirements of the By-Law shall apply.</p>

SECTION 10: COMMERCIAL (C) ZONES

By-Law No.	Zone Code	Description
Not Available	C2-27	Notwithstanding any provision of this By-Law to the contrary, within any area <i>zoned</i> C2-27 on Schedule “A” hereto, the <i>uses</i> permitted in Special Industrial (M1) <i>Zone</i> shall also be permitted. All other requirements of the By-Law shall apply.
Not Available	C2-28	Notwithstanding any provision of this By-Law to the contrary, within any area <i>zoned</i> C2-28 on Schedule “A” hereto, the <i>uses</i> permitted in Residential Multiple High Density (RM3) <i>Zone</i> shall also be permitted. All other requirements of the By-Law shall apply.

SECTION 10: COMMERCIAL (C) ZONES

10.9 Special Exceptions C3 Zone

By-Law No.	Zone Code	Description
PL2452, 63-08	C3-1	<p>Notwithstanding any provision of this By-Law to the contrary, within any area <i>zoned</i> C3-1 on Schedule “A” hereto, the permitted <i>uses</i> shall be limited to a <i>shopping centre</i> which may contain any of the <i>uses</i> of the C1 Zone subject to the following regulations or exceptions:</p> <ul style="list-style-type: none"> a) a <i>financial institution</i> shall not be permitted; b) the <i>floor area</i> occupied by any <i>pharmacy</i> shall not exceed 372 square metres; c) any area <i>zoned</i> C3-1 shall be and remain a single <i>lot</i> and the <i>floor area</i> of all <i>buildings and structures</i> on that <i>lot</i> shall not exceed 12,077 square metres. <p>All other requirements of the By-Law shall apply.</p>
Not Available	C3-2	<p>Notwithstanding any provision of this By-Law to the contrary, within any area <i>zoned</i> C3-2 on Schedule “A” hereto, the following shall apply:</p> <p><u>Additional permitted uses:</u></p> <ul style="list-style-type: none"> a) a liquor, beer and/or wine store to a maximum of 372 sq. mt.; b) a <i>convenience store</i> to a maximum of 300 square metres; c) an <i>office supply outlet</i> (retail only – no wholesale) to a maximum of 900 square metres; d) an <i>automobile service station</i>, gas bar, <i>car wash</i> and drive-through <i>restaurant</i>. <p><u>C1 uses permitted with limitations:</u></p> <ul style="list-style-type: none"> a) a <i>pharmacy</i> to a maximum of 235 square metres, and b) a <i>financial institution</i> to a maximum of 235 square metres. <p><u>Yard Requirements:</u></p> <ul style="list-style-type: none"> a) The minimum <i>front yard</i> of an institutional <i>use</i> shall be 15.0 metres, and the minimum <i>front yard</i> of an <i>automobile service station</i>, gas bar, <i>car wash</i> and drive-through <i>restaurant use</i> shall be 16.0 metres; b) The minimum right (north) interior <i>side yard</i> of an institutional <i>use</i> shall be 10.0 metres, the minimum right (north) interior <i>side yard</i> of a commercial <i>use</i> shall be 7.0 metres, and the minimum right (north) interior <i>side yard</i> of an <i>automobile service station</i>, gas bar, <i>car wash</i> and drive-through <i>restaurant use</i> shall be 49 metres;

SECTION 10: COMMERCIAL (C) ZONES

By-Law No.	Zone Code	Description
		<p>c) The minimum <i>rear yard</i> of an institutional use shall be 7.0 metres, and the minimum <i>rear yard</i> of an <i>automobile service station</i>, gas bar, <i>car wash</i> and drive-through <i>restaurant use</i> shall be 49 metres;</p> <p>d) The minimum left (south) interior <i>side yard</i> shall be 0.0 m.</p> <p><u>Other:</u></p> <p>a) A 6.0m landscaped buffer strip shall be provided adjacent to the north and west <i>lot lines</i>;</p> <p>b) The minimum landscaped area shall be 15 percent;</p> <p>c) The maximum <i>lot coverage</i> (excluding institutional uses) shall be 25 per cent;</p> <p>d) The ground <i>floor area</i> of any individual commercial use on the <i>lot</i> shall not exceed 929 square metres, save and except an <i>office supply outlet</i> which is limited to a maximum of 900 square metres and excluding institutional uses;</p> <p>e) The maximum <i>height</i> of any permitted use shall be one storey adjacent to the north and west <i>lot lines</i>.</p> <p>All other requirements of the By-Law shall apply.</p>

SECTION 10: COMMERCIAL (C) ZONES

10.10 Special Exceptions C4 Zone

By-Law No.	Zone Code	Description
Not Available	C4-1	Notwithstanding any provisions of this By-Law to the contrary, within any area <i>zoned</i> C4-1 on Schedule "A" hereto, a <i>medical office</i> , a place of entertainment, a <i>service shop</i> and a maximum of three (3) accessory dwelling units located on the second floor, as well as <i>uses, buildings, and structures accessory</i> to the foregoing permitted <i>uses</i> shall also be permitted. All other requirements of the By-Law shall apply.
Not Available	C4-2	Notwithstanding any provisions of this By-Law to the contrary, within any area <i>zoned</i> C4-2 on Schedule "A" hereto, in addition to the <i>uses</i> permitted in the Core Area Commercial (C4) <i>Zone</i> , an <i>automobile sales or rental establishment</i> shall also be permitted. All other requirements of the By-Law shall apply.

SECTION 10: COMMERCIAL (C) ZONES

10.11 Special Exceptions C5 Zone

By-Law No.	Zone Code	Description
59-09, 39-14, 110-15	C5-1	<p>Notwithstanding any provisions of this By-law to the contrary, within any area zoned C5-1 on Schedule "A" hereto, the uses shall be limited to the following:</p> <ul style="list-style-type: none"> a) <i>Amusement game establishment;</i> b) Bake shop; c) Catalogue store; d) <i>Commercial recreational establishment;</i> e) <i>Commercial school;</i> f) Continuum-of-care facility; g) <i>Convenience store</i> (maximum 300m²); h) Data processing establishment; i) <i>Day care;</i> j) <i>Dwelling units</i> restricted to above the first floor; k) <i>Florist shop;</i> l) Food store; m) Hardware store; n) <i>Home Improvement Centre;</i> o) Institutional use; p) Laboratory; q) <i>Dry Cleaning and Laundromat;</i> r) <i>Medical office;</i> s) Office; t) <i>Personal service establishment;</i> u) Place of entertainment; v) <i>Printing establishment;</i> w) <i>Library;</i> x) <i>Recreational establishment;</i> y) Repair and rental establishment; z) <i>Restaurant</i>, fast food, but does not include a <i>drive through restaurant</i>; aa) <i>Retail store;</i> bb) <i>Service shop;</i> cc) <i>Studio;</i> dd) Tavern; ee) <i>Veterinary clinic;</i> <p>All other requirements of the By-Law shall apply.</p>

SECTION 10: COMMERCIAL (C) ZONES

10.12 Special Exceptions C6 Zone

By-Law No.	Zone Code	Description
Not Available	C6-1	Notwithstanding any provisions of this By-Law to the contrary, within any area <i>zoned</i> C6-1 on Schedule "A" hereto, the permitted <i>uses</i> shall be limited to an <i>automobile repair garage</i> and a <i>single detached dwelling</i> . All other requirements of the By-Law shall apply.
Not Available	C6-2	Notwithstanding any provisions of this By-Law to the contrary, within any area <i>zoned</i> C6-2 on Schedule "A" hereto, in addition to the <i>uses</i> permitted in C6 Zone, a body shop shall also be permitted. All other requirements of the By-Law shall apply.
Not Available	C6-3	Notwithstanding any provisions of this By-Law to the contrary, within any area <i>zoned</i> C6-3 on Schedule "A" hereto, the permitted <i>uses</i> shall be limited to <i>automobile sales and rental establishment, automobile repair garage, automobile service station; convenience store and deli; and accessory uses, buildings and structures</i> . All other requirements of the By-Law shall apply.
Not Available	C6-4	Notwithstanding any provisions of this By-Law to the contrary, within any area <i>zoned</i> C6-4 on Schedule "A" hereto, the permitted <i>uses</i> shall be limited to an <i>automobile sales and rental establishment and automobile repair garage</i> . All other requirements of the By-Law shall apply.
Not Available	C6-5	Notwithstanding any provisions of this By-Law to the contrary, within any area <i>zoned</i> C6-5 on Schedule "A" hereto, the permitted <i>uses</i> shall be limited to an <i>automobile service station and convenience store</i> to the extent <i>existing</i> on December 10, 1984; a <i>single dwelling unit</i> ; and <i>accessory uses, buildings and structures</i> . All other requirements of the By-Law shall apply.
140-03	C6-6	Notwithstanding the provisions of this By-Law to the contrary, within any area <i>zoned</i> C6-6 on Schedule "A" hereto, the permitted <i>uses</i> shall be limited to an <i>automobile storage area</i> totally within a fenced compound. All other requirements of the By-Law shall apply.

SECTION 10: COMMERCIAL (C) ZONES

By-Law No.	Zone Code	Description
51-04	C6-7	Notwithstanding any provisions of this By-Law to the contrary, within any area <i>zoned</i> C6-7 on Schedule "A" hereto, the permitted <i>uses</i> shall be limited to <i>automobile sales and rental establishment, automobile repair garage; an automobile service station; a convenience store and a retail store</i> , not exceeding 93 square metres in area for the sales of golf equipment and accessories. All other requirements of the By-Law shall apply.
167-06	C6-8	Notwithstanding any provision of this By-Law to the contrary, within any area <i>zoned</i> C6-8 on Schedule "A" hereto, the permitted <i>uses</i> shall be limited to <i>automobile sales and rental establishment, automobile repair garage;, an automobile service station, a convenience store and a deli</i> . The minimum interior left (south) <i>side yard</i> for the <i>existing</i> propane facility shall be 3.0 metres. All other requirements of the By-Law shall apply.

SECTION 11: EMPLOYMENT (M) ZONES

11.1 Uses Permitted

No person shall within any Employment (M) Zones, use any lot or erect, alter or use any building or structure for any purpose except for one or more of the following uses as identified by a “dot”.

The Employment Zones established by this By-Law are as follows:

M1	Prestige Industrial
M2	Light Industrial
M3	Heavy Industrial
M4	Energy and Waste Industrial

Table 11.1: Uses Permitted

List of Uses	Zones			
	M1	M2	M3	M4
<i>Auction Establishment</i>		•	•	
<i>Auto Body Shop</i>		•	•	
<i>Automobile Repair Garage</i>		•	•	
<i>Automobile Sales or Rental Establishment</i>		•	•	
<i>Banquet Hall</i>	•	•		
<i>Building Supply Outlet</i>		•	•	
<i>Bulk Sales Establishment</i>		•	•	
<i>Catering Establishment</i>	•	•	•	
<i>Chemical and Pharmaceutical Industry</i>			•	
<i>Contractor’s Yard</i>		•	•	
<i>Day Care, accessory to the permitted use</i>	•	•		
<i>Dry Cleaning Establishment</i>			•	
<i>Electrical and Electronic Products Industry</i>		•	•	
<i>Electricity Generation Facility</i>				•
<i>Food Processing Plant</i>			•	

SECTION 11: EMPLOYMENT (M) ZONES

List of Uses	Zones			
	M1	M2	M3	M4
<i>Hotel</i>	•	•		
<i>Impounding Yard</i>			•	
<i>Manufacturing Facility</i>		•	•	
<i>Medical Marijuana Production Facility</i>		•	•	
<i>Office, Business/Professional</i>	•	•		
<i>Office Supply Outlet¹</i>	•	•		
<i>Office, Support</i>	•	•	•	•
<i>Open Storage accessory to the permitted use, in accordance with Section 11.4</i>		•	•	
<i>Paper Products Industry</i>			•	
<i>Printing Establishment</i>		•	•	
<i>Processed Goods Industry</i>			•	
<i>Propane Transfer Facility</i>			•	
<i>Recreational Establishment</i>	•	•	•	
<i>Recycling Facility</i>				•
<i>Research and Development Establishment</i>		•	•	
<i>Restaurant</i>	• ²	•	•	
<i>Retail Store accessory to permitted use in accordance with Section 11.2</i>	•	•	•	
<i>Salvage Yard</i>				•
<i>Service and Rental Establishment</i>		•	•	
<i>Shipping Container, in accordance with Section 4.35</i>		•	•	•
<i>Taxi Stand</i>		•		
<i>Transport/Truck Terminal</i>			•	
<i>Veterinary Clinic</i>	•	•		
<i>Waste Disposal Site</i>				•
<i>Waste Transfer Station</i>				•
<i>Warehouse, Public Self Storage</i>		•	•	

SECTION 11: EMPLOYMENT (M) ZONES

List of Uses	Zones			
	M1	M2	M3	M4
<i>Warehouse</i>		•	•	
<i>Wholesale Establishment</i>		•	•	

1 The maximum gross floor area for an office supply outlet in M1 Zone shall not exceed 930 sq. mt.

2 Restaurant shall be accessory to the main use in M1 Zone

11.2 Zone Requirements

No person shall within any Employment (M) Zones, use any lot or erect, alter or use any building or structure except in accordance with the following provisions:

Table 11.2: Zone Provisions

Provisions	Specifications			
	M1	M2	M3	M4
Lot Area , Minimum (sq. m)	1100	1100	1100	1100
Lot Frontage , Minimum (metres)	30.0	20.0	30.0	30.0
Street Setback , Minimum (metres)	9.0	6.0	50.0	30.0
Interior Side Yard Setback , Minimum (metres)	3.0	3.0	3.0	30.0
Rear Yard Setback , Minimum (metres)	8.0	8.0	8.0	30.0
Any Yard abutting Residential or Institutional Zone (metres)	7.5	10.0	15.0	30.0
Any Yard abutting railway right-of-way (metres)	0	0	0	0
Lot Coverage , Maximum	60%	60%	60%	60%
Landscaped Open Space , Minimum	10%	10%	10%	30%
Building Height , Maximum (metres) *	12.0	12.0	12.0	12.0
Floor Area of Retail Store , Maximum	10% of the gross floor area of the	10% of the gross floor area of the		

SECTION 11: EMPLOYMENT (M) ZONES

Provisions	Specifications			
	M1	M2	M3	M4
	permitted use to which it is accessory.	permitted use to which it is accessory.		

* Provided that if any portion of any building is erected above a height of 12.0 metres, the required yard dimensions shall be increased by 1.0 metres for each 1.0 metres by which such portion of the building exceeds 12.0 metres.

11.3 Yard Requirement for Hotels

A minimum side or rear yard of 7.5 metres shall be provided for any hotel in M1 or M2 Zone where:

- a) The principal entrance to such hotel is obtained through the side yard or rear yard; and/or
- b) A wall of such hotel contains a window to a habitable room facing such side yard or rear yard.

11.4 Open Storage Regulations

- a) No open storage of goods or materials in a M2 Zone shall be permitted except in accordance with the following provisions:
 - (i) the open storage is accessory to the use of the main building on the lot;
 - (ii) the open storage complies with the yard and setback requirements of this section;
 - (iii) the open storage does not cover more than thirty-five percent (35%) of the lot area nor exceed twice the floor area of the main building on the lot;
 - (iv) any portion of the area used for open storage, is concealed from view from the street by a fence or wall;
 - (v) the open storage shall be located only to the rear of the main building and shall not be located in the front or exterior side yard.
- b) Any part of the lot used for open storage of goods or materials in a M3 Zone shall be fenced.

SECTION 11: EMPLOYMENT (M) ZONES

11.5 Special Exceptions M1 Zone

By-Law No.	Zone Code	Description
Not Available	M1-1	Notwithstanding any provisions of this By-Law to the contrary, within any area <i>zoned</i> M1-1 on Schedule "A" hereto, the permitted <i>uses</i> shall be limited to a food condensing and processing business. All other requirements of the By-Law shall apply.
95-05	M1-2	Notwithstanding any provisions of this By-Law to the contrary, within any area <i>zoned</i> M1-2 on Schedule "A" hereto, the permitted <i>uses</i> shall be limited to a <i>contractor's yard</i> for construction and excavation equipment. Furthermore, the minimum <i>rear yard</i> shall be 3.4 metres. All other requirements of the By-Law shall apply.
Not Available	M1-3	<p>Notwithstanding any provisions of this By-Law to the contrary, within any area <i>zoned</i> M1-3 on Schedule "A" hereto, the permitted <i>uses</i> shall be limited to an airport owned by the City of Brantford including the operation, repair, maintenance and storage of aircraft and <i>accessory</i> functions such as <i>private clubs</i> and commercial aircraft or related companies and industrial <i>uses</i> involved with manufacturing, assembly, repair, fabricating, storage and/or technical services which rely on a location adjacent to an airport.</p> <p>Furthermore, the following <i>uses</i> or activities shall not be permitted:</p> <ul style="list-style-type: none"> a) the underground transmission of oil, gasoline, or other petroleum products; b) wood preserving and treating; c) outdoor storage of road salt, or other de-icing materials or the dumping of salt laden snow; d) petroleum production, refining, or manufacturing; e) furniture and wood striping and refinishing; f) horticultural nurseries; g) landfills; h) chemical/biological laboratory; i) disposal of leachable waste; j) electroplaters and metal fabricators; k) asphalt/concrete/tar plants; l) automobile <i>salvage yards</i>; m) <i>car washes</i>; n) <i>dry cleaning establishment</i>; o) cemeteries; p) gasoline service stations; q) underground storage tanks. <p>All other requirements of the By-Law shall apply.</p>

SECTION 11: EMPLOYMENT (M) ZONES

By-Law No.	Zone Code	Description
101-02	M1-4	Notwithstanding any provisions of this By-Law to the contrary, within any area <i>zoned</i> M1-4 on Schedule "A" hereto, the permitted <i>uses</i> shall be limited to the parking and storage of newly and/or partially assembled <i>school</i> buses and a portable office <i>building</i> or <i>structure accessory</i> to bus parking and storage. Furthermore, the maximum <i>gross floor area</i> for the administration office shall be 50 m ² . All other requirements of the By-Law shall apply.
Not Available	M1-5	Notwithstanding any provisions of this By-Law to the contrary, within any area <i>zoned</i> M1-5 on Schedule "A" hereto, in addition to the <i>uses</i> permitted in the Prestige Industrial (M1) <i>Zone</i> , a <i>retail store</i> engaged in the sale of new and <i>used</i> office furniture, industrial shelving, office supplies and <i>accessory uses</i> not exceeding a <i>gross floor area</i> of 1300 square metres shall also be permitted. <i>Accessory uses, buildings and structures</i> shall also be permitted. All other requirements of the By-Law shall apply.
Not Available	M1-6	Notwithstanding any provisions of this By-Law to the contrary, within any area <i>zoned</i> M1-6 on Schedule "A" hereto, in addition to the <i>uses</i> permitted in the Prestige Industrial (M1) <i>Zone</i> , an outdoor recreation <i>use</i> shall also be permitted. All other requirements of the By-Law shall apply.
280-04	M1-7	Notwithstanding any provision of this By-Law to the contrary, within any area <i>zoned</i> M1-7 on Schedule "A" hereto, a <i>public self-storage warehouse</i> shall also be a permitted <i>use</i> . All other requirements of the By-Law shall apply.

SECTION 11: EMPLOYMENT (M) ZONES

By-Law No.	Zone Code	Description
197-11	M1-8	<p>Notwithstanding any provision of this By-Law to the contrary, within any area <i>zoned</i> M1-8 on Schedule “A” hereto, a plant producing clay bricks shall be permitted <i>use</i>. Said brick production and storage of raw material shall be enclosed, finished brick products may be stored outside subject to the applicable provisions of this By-Law. Notwithstanding the provisions of section 4.18, 4.31 and 5.10, <i>open storage</i> may be permitted in any <i>yard</i> in accordance with the following:</p> <ul style="list-style-type: none"> a) Such <i>open storage</i> is <i>accessory</i> to the <i>use</i> of the <i>main building</i> on the <i>lot</i>. b) The <i>open storage</i> does not cover more than 35% of the <i>lot area</i> nor exceed twice the <i>ground floor area</i> of the <i>main building</i>. c) Bus storage in a <i>yard</i> adjacent to the intersection of Colborne Street West with Airport Road shall be screened from view from Colborne Street West and Airport Road by a 6.0 metre wide <i>planting strip</i> which shall be extensively planted and maintained with both coniferous and deciduous trees in a ratio of 70% and 30% respectively the along road length of the respective areas <i>used</i> for bus storage purposes. d) All permitted <i>open storage</i> shall only occur upon the construction and maintenance of a 2.0 metre high (minimum) closed visual screen. Such closed visual screen shall consist of an earthen <i>berm</i>, solid stone, simulated stone, or masonry wall or any combination thereof. The requirement for and details regarding the 2.0 metre high (minimum) closed visual screen shall be incorporated into the Site Plan Control Agreement and located adjacent to any permitted <i>open storage</i> along Colborne St. West and extending northerly along the westerly <i>lot line</i> a distance of 55.0 metres. e) <i>Open storage</i> of finished brick products shall not exceed <i>height</i> of 3.35 metres. f) Any loading area for raw clay materials shall be completely enclosed and limited to the north wall of the permitted <i>building</i>. <p>The removal of finished brick products from the permitted <i>building</i> shall not be located along the southerly wall of the permitted <i>building</i>. All other requirements of the By-Law shall apply.</p>
Not Available	M1-9	<p>Notwithstanding any provisions of this By-Law to the contrary, within any area <i>zoned</i> M1-9 on Schedule "A" hereto, the permitted <i>uses</i> shall be limited to a manufacturing plant and a machine shop. All other requirements of the By-Law shall apply.</p>

SECTION 11: EMPLOYMENT (M) ZONES

By-Law No.	Zone Code	Description
Not Available	M1-10	<p>Notwithstanding any provisions of this By-Law to the contrary, within any area <i>zoned</i> M1-10 on Schedule "A" hereto, the permitted <i>uses</i> shall be limited to a manufacturing and assembly plant for textiles, canvas, sporting equipment, related <i>accessory</i> products, and <i>accessory uses</i> including a <i>business office</i>.</p> <p>The manufacturing operations shall not exceed a maximum <i>gross floor area</i> of 8,000 square metres and shall be limited to a one-storey <i>structure</i>.</p> <p>Furthermore, the westerly <i>interior side yard</i> shall be 1.1 metres, no outside storage shall be permitted and the lands are exempt from the <i>setback</i> provisions for <i>lots</i> abutting any Residential <i>Zone</i>.</p> <p>All other requirements of the By-Law shall apply.</p>
187-2023	M1-11	<p>The lands zoned h-M1-11 may only be used in accordance with the permitted uses in the h-M1-11 Zone upon the removal of the "Holding (h)" provision. Notwithstanding Section 15.1 of this By-law, removal of the "h" may occur once the following provisions have been satisfied:</p> <ol style="list-style-type: none"> <li data-bbox="488 1035 1435 1140">.1 That the applicant has provided a signed Site Plan Agreement to the Corporation of the City of Brantford, along with all necessary securities; and, <li data-bbox="488 1199 1435 1304">.2 That all servicing issues, financial and otherwise, have been addressed to the satisfaction of The Corporation of the City of Brantford. <li data-bbox="488 1362 1435 1719">.3 That a Transportation Impact Study be submitted, to the satisfaction of the Manager of Development Engineering, City of Brantford. This study will examine the transportation impact of the ultimate use(s) to the area transportation network and take into consideration future development projects in the area and planned transportation improvements. Prior to commencement of the study, a pre-approved Terms of Reference must be determined through discussions between City Staff and a Transportation Consultant. <p>Notwithstanding any provision of this By-law to the contrary, as shown on Schedule "A", any lot within any M1-11 Zone may be used for all of the uses permitted in the M1 Zone plus the following</p>

SECTION 11: EMPLOYMENT (M) ZONES

11.6 Special Exceptions M2 Zone

By-Law No.	Zone Code	Description
Not Available	M2-1	Notwithstanding any provisions of this By-Law to the contrary, within any area <i>zoned</i> M2-1 on Schedule "A" hereto, in addition to the <i>uses</i> permitted in the Light Industrial (M2) Zone, a take-out <i>restaurant</i> with a maximum <i>floor area</i> of 83.6 square metres shall also be permitted. All other requirements of the By-Law shall apply.
Not Available	M2-2	Notwithstanding any provisions of this By-Law to the contrary, within any area <i>zoned</i> M2-2 on Schedule "A" hereto, in addition to the <i>uses</i> permitted in the Light Industrial (M2) Zone, a flea market and an <i>auction establishment</i> shall also be permitted. Furthermore, all activities shall be carried on inside the <i>building</i> except for outside sales that shall be regulated by a <i>site plan agreement</i> . All other requirements of the By-Law shall apply.
Not Available	M2-3	Notwithstanding any provisions of this By-Law to the contrary, within any area <i>zoned</i> M2-3 on Schedule "A" hereto, the permitted <i>uses</i> shall be limited to: <ul style="list-style-type: none"> a) <i>business or professional offices</i>; b) <i>computer, electronic or data processing business</i>; c) <i>a manufacturing plant not exceeding 2350 square metres floor area</i>; d) <i>printing establishment</i>; e) <i>community centre/recreational establishment</i>; f) <i>research establishment</i>; g) <i>a retail store, wholesale establishment accessory to a permitted use</i>; h) <i>service or repair shop</i>; i) <i>warehouse</i>; j) <i>contractor's yard</i>; k) <i>establishment for the sale, rental or service of business machines and office supplies</i>; l) <i>restaurant</i>; m) <i>teaching and training centre</i>; n) <i>convenience store</i>. Furthermore, outside storage shall be prohibited in the <i>rear yard</i> , parking shall be located in the <i>front yard</i> , and <i>loading space</i> may be located in the <i>front yard</i> . All other requirements of the By-Law shall apply.

SECTION 11: EMPLOYMENT (M) ZONES

By-Law No.	Zone Code	Description
Not Available	M2-4	Notwithstanding any provisions of this By-Law to the contrary, within any area <i>zoned</i> M2-4 on Schedule "A" hereto, in addition to the <i>uses</i> permitted in the Light Industrial (M2) <i>Zone</i> , an <i>assembly hall</i> , a <i>banquet hall</i> and a caretakers apartment unit shall also be permitted. Furthermore, parking for the <i>assembly hall</i> and <i>banquet hall</i> may be permitted within the front and <i>rear yard</i> . No outside storage shall occur within the <i>rear yard</i> . All other requirements of the By-Law shall apply.
Not Available	M2-5	Notwithstanding any provisions of this By-Law to the contrary, within any area <i>zoned</i> M2-5 on Schedule "A" hereto, in addition to the <i>uses</i> permitted in the Light Industrial (M2) <i>Zone</i> , a caretaker's unit shall also be permitted. All other requirements of the By-Law shall apply.
Not Available	M2-6	Notwithstanding any provisions of this By-Law to the contrary, within any area <i>zoned</i> M2-6 on Schedule "A" hereto, in addition to the <i>uses</i> permitted in the Light Industrial (M2) <i>Zone</i> , an <i>auto body shop</i> and <i>salvage yard</i> shall also be permitted. All other requirements of the By-Law shall apply.
Not Available	M2-7	Notwithstanding any provisions of this By-Law to the contrary, within any area <i>zoned</i> M2-7 on Schedule "A" hereto, in addition to the <i>uses</i> permitted in the Light Industrial (M2) <i>Zone</i> , an <i>auto body shop</i> and an auto refurbishing business shall also be permitted. Furthermore, both <i>uses</i> shall be restricted to the interiors of the <i>building</i> and no outside storage of materials, <i>vehicles</i> or parts of <i>vehicles</i> shall be permitted. All other requirements of the By-Law shall apply.

SECTION 11: EMPLOYMENT (M) ZONES

By-Law No.	Zone Code	Description
95-05	M2-8	<p>Notwithstanding any provisions of this By-Law to the contrary, within any area <i>zoned</i> M2-8 on Schedule "A" hereto, the permitted <i>uses</i> shall be limited to,</p> <ul style="list-style-type: none"> a) a manufacturing plant, b) a fabricating plant, c) an assembly plant, d) a <i>warehouse</i>, e) a <i>parking lot</i>, f) <i>open storage accessory</i> to any permitted <i>use</i>, g) a <i>retail store</i>, a <i>wholesale establishment</i> or a <i>business office accessory</i> to a permitted <i>use</i>. h) Furthermore, the minimum <i>front yard</i> for the <i>existing building</i> shall be 6 metres; the minimum interior easterly <i>side yard</i> shall be 5.5 metres. i) Also, the minimum <i>setback</i> of any industrial <i>building</i> shall be 57 metres from any neighbouring residential <i>dwelling</i>. <p>All other requirements of the By-Law shall apply.</p>
Not Available	M2-9	<p>Notwithstanding any provisions of this By-Law to the contrary, within any area <i>zoned</i> M2-9 on Schedule "A" hereto, in addition to the <i>uses</i> permitted in the Light Industrial (M2) <i>Zone</i>, an <i>automobile repair garage</i>, <i>automobile sales establishment</i>, and a <i>single detached dwelling</i> shall also be permitted.</p> <p>Furthermore, <i>vehicles</i> that are being retailed or wholesaled shall not be located within 60 metres of the southern limit of County Road 4, and the maximum number of <i>vehicles</i> that may be parked outside awaiting sale shall be limited to 8.</p> <p>All other requirements of the By-Law shall apply.</p>
Not Available	M2-10	<p>Notwithstanding any provisions of this By-Law to the contrary, within any area <i>zoned</i> M2-10 on Schedule "A" hereto, in addition to the <i>uses</i> permitted in the Light Industrial (M2) <i>Zone</i>, a <i>livestock use</i> for the stabling of horses being restricted to a maximum of 112 square metres, an indoor horse <i>riding arena</i> limited to a maximum of 600 square metres shall also be permitted.</p> <p>Furthermore, any <i>building</i> or portion thereof to be <i>used</i> for the stabling of <i>livestock</i> or as an indoor horse <i>riding arena</i> shall be located a minimum of 61 metres from the nearest residence on an adjoining <i>lot</i>. All other requirements of the By-Law shall apply.</p>

SECTION 11: EMPLOYMENT (M) ZONES

By-Law No.	Zone Code	Description
82-11	M2-11	<p>Notwithstanding any provision of this By-Law to the contrary, within any area <i>zoned</i> M2-11 on Schedule “A” hereto, in addition to the <i>uses</i> permitted in the (M2) <i>Zone</i>, a medical/dental and related <i>uses</i> facility shall also be permitted.</p> <p>All other requirements of the By-Law shall apply.</p>
73-12, 56-14	M2-12	<p>Notwithstanding any provision of this By-Law to the contrary, within any area <i>zoned</i> M2-12 on Schedule “A” hereto, in addition to the <i>uses</i> permitted in the M2 <i>Zone</i>, a recreational <i>use</i> consisting of a shooting and archery club including members’ lounge, offices and related retail sales of shooting and archery equipment, supplies and related paraphernalia shall also be permitted. The said retail <i>uses</i> shall not exceed 440 square metres.</p> <p>All other requirements of the By-Law shall apply.</p>
60-15 OMB – PL150471	M2-13	<p>Notwithstanding the provisions of this By-Law to the contrary, within any area <i>zoned</i> M2-13 on Schedule ‘A’ hereto, the permitted <i>uses</i> shall be limited to the following:</p> <ul style="list-style-type: none"> a) <i>Office, Business</i> b) <i>Contractor’s Yard</i> c) <i>Light Manufacturing</i> d) <i>Service and Rental Establishment</i> e) <i>Service Shop</i> f) <i>Accessory Use</i> <p>For the purpose of this By-Law, “Light Manufacturing means the manufacturing, assembly or processing of component parts to produce finished products suitable for retail trade and does not include food, beverage, tobacco, rubber, leather, textile and knitting, wood, printing, metal fabricating or similar industries.”</p> <p>The above noted uses are to be contained within an <i>accessory structure</i> with a maximum <i>gross floor area</i> of 3,048 m² to a maximum of 45% of the total <i>lot coverage</i>. <i>Open storage accessory</i> to any <i>main use</i> shall be permitted, located to the east of the existing <i>structure</i> and having a maximum area of 255 m². An existing <i>dwelling unit</i> shall also be permitted on the <i>lot</i>.</p> <p>All other requirements of the By-Law shall apply.</p>

SECTION 11: EMPLOYMENT (M) ZONES

11.7 Special Exceptions M3 Zone

By-Law No.	Zone Code	Description
Not Available	M3-1	<p>Notwithstanding any provisions of this By-Law to the contrary, within any area <i>zoned</i> M3-1 on Schedule "A" hereto, the permitted <i>uses</i> shall be limited to</p> <ul style="list-style-type: none">a) a <i>contractor's yard</i> for an excavation, bulldozing and construction business and related <i>buildings, structures accessory</i> thereto;b) a machinery and agricultural equipment repair shop; andc) an <i>auto body shop</i>. <p>All other requirements of the By-Law shall apply.</p>
Not Available	M3-2	<p>Notwithstanding any provisions of this By-Law to the contrary, within any area <i>zoned</i> M3-2 on Schedule "A" hereto, in addition to the <i>uses</i> permitted in the Heavy Industrial (M3) <i>Zone</i>, a concrete <i>batching plant</i> shall also be permitted. All other requirements of the By-Law shall apply.</p>
175-05	M3-3	<p>Notwithstanding any provision of this By-Law to the contrary, within any area <i>zoned</i> M3-3 on Schedule "A" hereto, the permitted <i>uses</i> shall be limited to a <i>transport/truck terminal</i>, a business involving the maintenance, service and repair of trucks, a <i>single detached dwelling</i>, and a <i>retail store</i>, or a <i>wholesale establishment</i> or a <i>business office accessory</i> to a permitted <i>use</i>. Furthermore, the minimum easterly <i>interior side yard setback</i> shall be 3.0 metres.</p> <p>All other requirements of the By-Law shall apply.</p>
Not Available	M3-4	<p>Notwithstanding any provisions of this By-Law to the contrary, within any area <i>zoned</i> M3-4 on Schedule "A" hereto, in addition to the <i>uses</i> permitted in the Heavy Industrial (M3) <i>Zone</i>, a gas bar, a motel, an <i>eating establishment</i>, a <i>car wash</i>, a farm implement dealer, and a <i>farm produce outlet</i> shall also be permitted. All other requirements of the By-Law shall apply.</p>

SECTION 11: EMPLOYMENT (M) ZONES

By-Law No.	Zone Code	Description
Not Available	M3-5	<p>Notwithstanding any provisions of the By-Law to the contrary, within any area <i>zoned</i> M3-5 on Schedule "A" hereto, in addition to the <i>uses</i> permitted in the Heavy Industrial (M3) <i>Zone</i>, a disposal site for solid non-hazardous foundry wastes <i>accessory</i> to foundries owned and operated by Wecast shall also be permitted. The disposal shall be limited to solid non-hazardous foundry wastes, as defined in Ontario Regulation 347 generated by the foundry as follows:</p> <ul style="list-style-type: none"> a) slag; b) waste sand; c) core butts; d) bag house waste; e) premix waste comprised of clay and coal dust; f) refractory; g) iron; h) wood packing wastes, pallets, floor sweepings, rubber belts and other miscellaneous wastes in small quantities. <p>All other requirements of the By-Law shall apply.</p>
79-15	M3-6	<p>Notwithstanding any provisions of this By-Law to the contrary, within any area <i>zoned</i> M3-6 on Schedule "A" hereto, the permitted <i>uses</i> shall be limited to wholesale and retail sale of building supplies, natural or similar landscaping hardscape materials with <i>accessory open storage</i>. All other requirements of the By-Law shall apply.</p>
Not Available	M3-7	<p>Notwithstanding any provisions of this By-Law to the contrary, within any area <i>zoned</i> M3-7 on Schedule "A" hereto, in addition to the <i>uses</i> permitted in the Heavy Industrial (M3) <i>Zone</i>, a <i>single detached dwelling accessory</i> to the <i>main industrial use</i> on the <i>lot</i> shall also be permitted. All other requirements of the By-Law shall apply.</p>
190-04, 232-04	M3-8	<p>Notwithstanding any provision of this By-Law to the contrary, within any area <i>zoned</i> M3-8 on Schedule "A" hereto, a <i>loading space</i> is permitted in any <i>yard</i>, including a <i>front yard</i>. All other requirements of the By-Law shall apply.</p>
263-04	M3-9	<p>Notwithstanding any provision of this By-Law to the contrary, within any area <i>zoned</i> M3-9 on Schedule "A" hereto, the permitted <i>use</i> of these lands shall be limited to a hydro-electric transformer and <i>uses accessory</i> thereto. All other requirements of the By-Law shall apply.</p>

SECTION 11: EMPLOYMENT (M) ZONES

By-Law No.	Zone Code	Description
95-05, 81-07	M3-10	Notwithstanding any provision of this By-Law to the contrary, within any area <i>zoned</i> M3-10 on Schedule “A” hereto, in addition to the <i>uses</i> permitted in the M3 Zone, a <i>retail store</i> selling home, agricultural, automotive and similar merchandise shall also be permitted. All other requirements of the By-Law shall apply.
101-05	M3-11	Notwithstanding any provision of this By-Law to the contrary, within any area <i>zoned</i> M3-11 on Schedule “A” hereto, the minimum <i>rear yard</i> (north) shall be 0.0m measured from the <i>Zone</i> limit. All other requirements of the By-Law shall apply.
176-02, 242-05, 70-12	M3-12	<p>Notwithstanding any provision of this By-Law to the contrary, within any area <i>zoned</i> M3-12 on Schedule “A” hereto, the permitted <i>uses</i> of land shall be limited to the following:</p> <ul style="list-style-type: none"> a) any <i>use</i> permitted in M2 Zone, save and except a <i>processed goods industry</i>; b) general manufacturing; c) manufacturing and assembly industry; d) municipal or provincial garage or storage yard; e) <i>office, support</i>; f) <i>open storage use</i> of goods or materials if <i>accessory</i> to a permitted <i>use</i>; g) <i>parking lot</i>; h) <i>printing establishment</i>; i) <i>transport/truck terminal</i>; j) <i>automobile repair garage</i>. <p>All <i>yard</i> dimensions shall be measured as if any abutting <i>lot</i> is <i>zoned</i> in an agricultural or an industrial Zone. All other requirements of the By-Law shall apply.</p>
141-08	M3-13	Notwithstanding any provision of this By-Law to the contrary, within any area <i>zoned</i> M3-13 on Schedule “A” hereto, an aggregate propane storage capacity not exceeding 310,000 litres shall be permitted. All other requirements of the By-Law shall apply.

SECTION 11: EMPLOYMENT (M) ZONES

By-Law No.	Zone Code	Description
107-09	M3-14	Notwithstanding any provision of this By-Law to the contrary, within any area <i>zoned</i> M3-14 on Schedule "A" hereto, in addition to the <i>uses</i> permitted in the M3 <i>Zone</i> , a medical and related <i>uses</i> facility is permitted. <i>Uses</i> that are secondary and incidental to various health practices, such as laboratories and imaging services, a coffee shop and/or cafeteria, meeting rooms and kitchen facilities available for community and non-profit <i>use</i> , dispensing of optical, hearing and like devices, a <i>pharmacy</i> not to exceed 235 square meters shall also be permitted. All other requirements of the By-Law shall apply.
95-05	M3-15	Notwithstanding the provisions of this By-Law to the contrary, within any area <i>zoned</i> M3-15 on Schedule "A" hereto, in addition to the <i>uses</i> permitted in the Heavy Industrial (M3) <i>Zone</i> , a <i>salvage yard</i> restricted to <i>vehicles</i> shall also be permitted. All other requirements of the By-Law shall apply.

SECTION 11: EMPLOYMENT (M) ZONES

11.8 Special Exceptions M4 Zone

By-Law No.	Zone Code	Description
-------------------	------------------	--------------------

SECTION 12: RESOURCE EXTRACTION (EX) ZONE

12.1 Uses Permitted

No *person* shall within any Resource Extraction (EX) *Zone*, use any *lot* or *erect*, *alter* or use any *building* or *structure* for any purpose except for one or more of the following *uses* as identified by a “dot”:

Table 12.1: Uses Permitted

List of Uses	Permitted
<i>Existing uses</i>	•
<i>Agricultural Use</i>	•
<i>Mineral Aggregate Operation</i>	•
<i>Mineral Aggregate Resource Conservation</i>	•
<i>Pit</i>	•
<i>Quarry</i>	•
<i>Shipping Container</i> , in accordance with Section 4.35	•

12.2 Zone Requirements

No *person* shall within any Resource Extraction (EX) *Zone*, use any *lot* or *erect*, *alter* or use any *building* or *structure* except in accordance with the following provisions:

Table 12.2: Zone Provisions

Provisions	Specifications
<i>Lot Area</i> , Minimum	NA
<i>Lot Frontage</i> , Minimum (metres)	NA
<i>Street Setback</i> , Minimum (metres)	18.0
<i>Interior Side Yard Setback</i> , Minimum (metres)	15.0
<i>Rear Yard Setback</i> , Minimum (metres)	15.0

SECTION 12: RESOURCE EXTRACTION (EX) ZONE

12.3 Special Exceptions EX Zone

By-Law No.	Zone Code	Description
Not Available	EX-1	<p>Notwithstanding any provisions of this By-Law to the contrary, within any area <i>zoned</i> EX-1 on Schedule "A" hereto, the minimum <i>yard</i> requirements for the face of the extraction of sand and gravel shall be as follows:</p> <ul style="list-style-type: none"> a) the minimum <i>rear yard</i> shall be 45 metres; b) the minimum northerly <i>interior side yard</i> shall be 15 metres; c) the minimum interior southerly <i>side yard</i> does not apply as it abuts an unopened <i>road allowance</i>; and d) the minimum <i>side yard/setback</i> between the easterly face of the extraction area and properties situated to the east shall be as follows: <ul style="list-style-type: none"> 1. for properties with the Assessment Roll No. 2920-016-020-31750, the minimum requirement shall be 75 metres; and 2. for the property with the Assessment Roll No. 2920-016-020-31700, the minimum <i>yard</i> requirement shall be 90 metres. <p>All other requirements of the By-Law shall apply.</p>
Not Available	EX-2	<p>Notwithstanding the provisions of this By-Law to the contrary, within any area <i>zoned</i> EX-2 on Schedule "A" hereto, the <i>Zone</i> requirements of the (EX) <i>Zone</i> shall apply with the following exceptions:</p> <ul style="list-style-type: none"> (i) no extraction shall take place below a depth of 1 metre above the water table other than in forming the settling ponds to clarify washwater as shown on the licensee's site plan; and (ii) no topsoil or subsoil shall be removed from the licensed <i>lot</i>; and (iii) the <i>pit</i> face <i>setback</i> on the northerly limit of the (EX) <i>Zone</i> shall be the <i>lot</i> boundary. <p>All other requirements of the By-Law shall apply.</p>

SECTION 12: RESOURCE EXTRACTION (EX) ZONE

By-Law No.	Zone Code	Description
Not Available	EX-3	<p>Notwithstanding the provisions of this By-Law to the contrary, within any area <i>zoned</i> EX-3 on Schedule "A" hereto, the <i>Zone</i> requirements of the (EX) <i>Zone</i> shall apply with the following exceptions:</p> <ul style="list-style-type: none">(i) no other <i>use</i> shall take place on the northeast corner of the lands, being a triangular-shaped portion measuring 100 metres west of Rest Acres Road and 200 metres south of Bethel Road except earth <i>berming</i> and tree screening <i>accessory</i> to a licensed <i>pit</i>;(ii) no extraction shall take place below a depth of 1 metre above the water table other than in forming the settling ponds to clarify washwater as shown on the licensee's site plan; and(iii) no topsoil or subsoil shall be removed from the licensed <i>lot</i>. <p>All other requirements of the By-Law shall apply.</p>

SECTION 13: INSTITUTIONAL (N) ZONES

13.1 Uses Permitted

No person shall within any Institutional (N) Zones, use any lot or erect, alter or use any building or structure for any purpose except for one or more of the following uses, as identified by a “dot”:

The Institutional Zones established by this By-Law are as follows:

N1 **Minor Institutional**
N2 **Major Institutional**

Table 13.1: Uses Permitted

List of Uses	N1	N2
<i>Art Gallery</i>		•
<i>Community Centre</i>	•	•
<i>Group Home, Correctional</i>		
<i>Day Care</i>	•	•
<i>Hospital</i>		•
<i>Library</i>	•	•
<i>Museum</i>		•
<i>Nursing Home</i>	•	•
<i>Office, Medical</i>		•
<i>Place of Worship</i>	•	•
<i>Retirement Home</i>	•	•
<i>School, Elementary</i>	•	•
<i>School, Private Elementary, excluding dormitory</i>	•	•
<i>School, Post-Secondary</i>		•
<i>School, Private Secondary</i>		•
<i>School, Secondary</i>		•

SECTION 13: INSTITUTIONAL (N) ZONES

13.2 Zone Requirements

No person shall within any Institutional (N) Zones, use any lot or erect, alter or use any building or structure except in accordance with the following provisions:

Table 13.2: Zone Provisions

Provisions	Specifications	
	N1	N2
Lot Area , Minimum (square metres)	450	10,000
Lot Frontage , Minimum (metres)	15.0	15.0
Street Setback , Minimum (metres)	6.0	10.0
Interior Side Yard Setback , Minimum (metres)	1.2	10.0
Rear Yard Setback , Minimum (metres)	6.0	10.0
Lot Coverage , Maximum	35%	40%
Landscaped Open Space , Minimum	30%	30%
Building Height , Maximum (metres)	10.0	15.0

13.3 Special Exceptions N1 Zone

By-Law No.	Zone Code	Description
Not Available	N1-1	Notwithstanding any provisions of this By-Law to the contrary, within any area zoned N1-1 on Schedule "A" hereto, in addition to the uses permitted in the Minor Institutional (N1) Zone, a funeral home with an accessory dwelling unit being occupied only by the owner, caretaker or an employee of the funeral home shall also be permitted. All other requirements of the By-Law shall apply.
Not Available	N1-2	Notwithstanding any provisions of this By-Law to the contrary, within any area zoned N1-2 on Schedule "A" hereto, the permitted uses shall be limited to a private school. All other requirements of the By-Law shall apply.

SECTION 13: INSTITUTIONAL (N) ZONES

By-Law No.	Zone Code	Description
170-02	N1-3	Notwithstanding any provisions of this By-Law to the contrary, within any area <i>zoned</i> N1-3 on Schedule 'A' hereto, a dance studio and School for the Arts shall be a permitted <i>use</i> . All other requirements of the By-Law shall apply.
136-15, 137-15, PL121076	N1-4	<p>Notwithstanding any provisions of this By-Law to the contrary, within any area <i>zoned</i> N1-4 on Schedule "A" hereto, in addition to the <i>uses</i> permitted in the Minor Institutional (N1) Zone, a <i>street fronting rowhouse dwelling</i> and a <i>rowhouse dwelling</i> in accordance with the following provisions shall also be permitted:</p> <p>a) For <i>street fronting rowhouse dwellings</i> the following minimum standards and all other requirements of the RM2 Zone shall apply:</p> <ul style="list-style-type: none"> (i) <i>Lot Area</i> (Minimum): 180 m² (ii) <i>Lot Frontage</i> (Minimum): 6.0 m (iii) <i>Front Yard</i> (Minimum): 4.5 m, provided no part of the <i>structure used as a carport or garage</i> is closer than 6.0 m to the <i>front lot line</i>. (iv) <i>Interior Side Yard</i> (Minimum): 1.5 m (v) <i>Exterior Side Yard</i> (Minimum): 4.5 m (vi) <i>Lot Coverage</i> (Maximum): 50% <p>b) <i>Rowhouse dwelling</i> in accordance with the following provisions and all other requirements of the RM2 Zone:</p> <ul style="list-style-type: none"> (i) <i>Minimum Front Yard</i>: 4.5 metres (provided no part of the <i>structure used as a garage</i> is closer than 6.0 metres to the <i>front lot line</i>, and that no <i>garage</i> portion of a <i>dwelling</i> is located nearer to the <i>street line</i> than the habitable part of the <i>dwelling</i>). (ii) <i>Lot Frontage</i> (minimum): 6.0 metres (iii) <i>Exterior Side Yard</i>: 3.0 metres (iv) <i>Interior Side Yard</i> (minimum): 1.2 metres (v) <i>Lot Coverage</i> (maximum): 45% (vi) <i>Privacy yards</i> (minimum): 6.0 metres adjoining each exterior wall of every <i>dwelling unit</i>. (vii) <i>The Rowhouse dwelling</i> may also have frontage on a <i>public street</i>. <p>All other requirements of the By-Law shall apply.</p>

SECTION 13: INSTITUTIONAL (N) ZONES

13.4 Special Exceptions N2 Zone

By-Law No.	Zone Code	Description
Not Available	N2-1	<p>Notwithstanding the provisions of this By-Law to the contrary, within any area <i>zoned</i> N2-1 on Schedule "A" hereto, in addition to the <i>uses</i> permitted in the Major Institutional (N2) <i>Zone</i>, following <i>uses</i> shall also be permitted:</p> <ul style="list-style-type: none">a) an <i>apartment dwelling</i> designed for the accommodation and occupancy by elderly and is owned and managed by a non-profit organization or a charitable institution containing a maximum of 130 <i>dwelling units</i>;b) a drug store having a maximum <i>gross floor area</i> of 40 square metres;c) a <i>convenience store</i> having a maximum <i>gross floor area</i> of 30 square metres and;d) a <i>medical office</i> having a maximum <i>gross floor area</i> of 40 square metres. <p>Furthermore, the <i>building height</i> shall not exceed 29.9 metres and a minimum of 130 <i>parking spaces</i> shall be provided. All other requirements of the By-Law shall apply.</p>

SECTION 14: OPEN SPACE (OS) ZONES

14.1 Uses Permitted

No *person* shall within any Open Space (OS) Zones, use any *lot* or *erect, alter* or use any *building* or *structure* for any purpose except for one or more of the following *uses* as identified by a “dot”.

The Open Space Zones established by this By-Law are as follows:

NH	Natural Heritage Zone
OS1	Open Space
OS2	Recreational Facilities
OS3	Recreational Trailer Park

Table 14.1: Uses Permitted

List of Uses	Zones			
	NH	OS1	OS2	OS3
<i>Agricultural Use, Existing</i>	•			
<i>Boat Dock</i>	•	•	•	•
<i>Boat Ramp</i>	•	•	•	•
<i>Campground</i>			•	•
<i>Cemetery</i>		•		
<i>Community Centre</i>			•	
<i>Fairground</i>			•	
<i>Forestry Uses</i> excluding any establishments that either process or sell processed forestry products such as <i>lumber mills</i> ;	•	•		
<i>Golf Course</i>			•	
<i>Place of Worship</i>		•		
<i>Public Park</i> or <i>Private Park</i>			•	•
<i>Stormwater Management Facility</i>	•	•	•	•
<i>Wildlife Management</i>	•	•		
<i>Recreational Establishment</i>			•	
<i>Recreational Trailer Park</i>				•

SECTION 14: OPEN SPACE (OS) ZONES

14.2 Zone Requirements for NH Zone

No *person* shall within any Natural Heritage (NH) *Zone*, use any *lot* or *erect, alter* or use any *building* or *structure* except in accordance with the following provisions:

- a) Other than *buildings* and *structures* existing at the date of passing of this By-Law, no *buildings* or *structures* are permitted unless for flood control purposes, and/or in accordance with the regulations of the *Conservation Authority*.
- b) Any additions to the *existing buildings* or *structures* in NH *Zone* shall comply with the regulations of the abutting *Zone* on the same lot subject to approval from the appropriate *Conservation Authority*.
- c) Within lands *Zoned* NH, a *boat house* and/or *boat dock* may be constructed, *erected* or located on lands or waters subject to approval from the *Conservation Authority*. Only one *boat house* and one dock shall be permitted on one *lot*.

14.3 Zone Requirements for OS1, OS2 and OS3 Zones

No *person* shall within any Open Space (OS1, OS2 or OS3) *Zone*, use any *lot* or *erect, alter* or use any *building* or *structure* except in accordance with the following provisions:

Table 14.2: Zone Provisions

Provisions	Specifications		
	OS1	OS2	OS3
Lot Area , Minimum (sq. m)	1000	1000	20 ha
Lot Frontage , Minimum (metres)	15.0	15.0	15.0
Street Setback , Minimum (metres)	6.0	7.5	25.0
Interior Side Yard Setback , Minimum (metres)	3.0	7.5	15.0
Rear Yard Setback , Minimum (metres)	3.0	7.5	15.0
Lot Coverage , Maximum	40%	40%	40%
Building Height , Maximum (metres)	10.0	10.0	10.0
Maximum Area for individual site in Recreational Trailer Park (sq. m)	-	-	185
Maximum Area for individual Campsite (sq. m)	-	150	150

SECTION 14: OPEN SPACE (OS) ZONES

14.4 Special Exceptions NH Zone

By-Law No.	Zone Code	Description
Not Available	NH-1	Notwithstanding any provision of this By-Law to the contrary, within any area <i>zoned</i> NH-1 on Schedule "A" hereto, a waste treatment facility is permitted. All other requirements of the By-Law shall apply.
227-02, 45-11	NH-2	Notwithstanding any provisions of this By-Law to the contrary, within any area <i>zoned</i> NH-2 on Schedule 'A' hereto, silos and other <i>structures</i> related to a flourmill shall be permitted subject to the approval of the appropriate <i>Conservation Authority</i> . All other requirements of the By-Law shall apply.

SECTION 14: OPEN SPACE (OS) ZONES

14.5 Special Exceptions OS1 Zone

By-Law No.	Zone Code	Description
Not Available	OS1-1	Notwithstanding any provisions of this By-Law to the contrary, within any area <i>zoned</i> OS1-1 on Schedule "A" hereto, the permitted <i>uses</i> shall be limited to a <i>cemetery</i> and a church but not including a <i>day care</i> , and an <i>accessory building</i> to any of the permitted <i>uses</i> . All other requirements of the By-Law shall apply.
121-02, 1-03, 133-13,	OS1-2	Notwithstanding any provisions of this By-Law to the contrary, within any area <i>zoned</i> OS1-2 on Schedule 'A' hereto, <i>uses</i> shall be limited to a <i>place of worship</i> and an <i>existing dwelling unit</i> . The <i>existing dwelling unit</i> shall be subject to the requirements of Agricultural (A) Zone. All other requirements of the By-Law shall apply.
Not Available	OS1-3	Notwithstanding any provisions of this By-Law to the contrary, within any area <i>zoned</i> OS1-3 on Schedule "A" hereto, the lands are recognized as a former <i>waste disposal site</i> . All other requirements of the By-Law shall apply.
95-05, 63-10	OS1-4	Notwithstanding the provisions of this By-Law to the contrary, within any area <i>zoned</i> OS1-4 on Schedule "A" hereto, the <i>height</i> of the <i>building</i> shall not exceed 13.0 meters. All other requirements of the By-Law shall apply.

SECTION 14: OPEN SPACE (OS) ZONES

By-Law No.	Zone Code	Description
108-09	OS1-5	<p>Notwithstanding any provision of this By-Law to the contrary, within any area <i>zoned</i> OS1-5 on Schedule “A” hereto, the following <i>development</i> standards shall apply:</p> <p><u>Building Location</u></p> <ul style="list-style-type: none"> a) The <i>yard</i> adjacent to Burwell Street is deemed to be the <i>front yard</i>; b) The <i>existing yards</i> adjacent to the church <i>building</i>-proper shall be deemed to conform to the requirements of the zoning By-Law; c) The minimum <i>interior side yard</i>, adjacent to the <i>rear yard</i> of No. 69 Grand River Street South shall be 1.5 meters; d) The minimum <i>rear yard</i>, adjacent to the north <i>side yard</i> of No. 69 Grand River Street South shall be 1.5 meters; e) The <i>rear yard</i> shall be at least 2.0 meters at the south-rear point of the parish hall. <p><u>Parking</u></p> <ul style="list-style-type: none"> a) Parking may be permitted in a <i>front yard</i>; b) Eight (8) <i>parking spaces</i> shall be provided, of which a minimum of two (2) spaces should be reserved for people with disabilities. <p><u>Site Development</u></p> <ul style="list-style-type: none"> a) Maximum <i>lot coverage</i>-60%; b) Minimum <i>landscaped open space</i>-30% <p><u>Building Height</u></p> <ul style="list-style-type: none"> a) Maximum <i>building height</i>, 7.3 meters, which excludes main <i>place of worship building</i> (i.e. <i>existing</i> stone church). <p>All other requirements of the By-Law shall apply.</p>

SECTION 14: OPEN SPACE (OS) ZONES

14.6 Special Exceptions OS2 Zone

By-Law No.	Zone Code	Description
20-11	OS2-1	Notwithstanding any provision of this By-Law to the contrary, within any area <i>zoned</i> OS2-1 on Schedule "A" hereto, the minimum <i>side yard setback</i> shall be 4.0 meters from the northerly <i>lot line</i> . All other requirements of the By-Law shall apply.
4-07	OS2-2	Notwithstanding the provisions of this By-Law to the contrary, within any area <i>zoned</i> OS2-2 on Schedule "A" hereto, the following <i>uses</i> and <i>accessory buildings</i> or <i>structures</i> shall be permitted: <ul style="list-style-type: none"> a) <i>golf course</i> including: <ul style="list-style-type: none"> i. pro shop ii. restaurant iii. clubhouse iv. banquet hall v. other <i>accessory uses</i> b) corporate centre with five executive suites for guest accommodation in the <i>existing dwelling</i> including facilities for recreational, social, education and/or meeting purposes; c) <i>private</i> roads, <i>driveways</i>, sidewalks, pathways and emergency access routes serving the lands <i>zoned</i> OS2-2 and the lands <i>zoned</i> R1-9; and private <i>amenity areas</i> for the <i>dwelling units</i> in the R1-9 Zone. <p>All other requirements of the By-Law shall apply.</p>
Not Available	OS2-3	Notwithstanding the provisions of this By-Law to the contrary, within any area <i>zoned</i> OS2-3 on Schedule "A" hereto, the permitted <i>uses</i> shall be limited to the following <i>uses</i> and <i>accessory buildings</i> or <i>structures</i> : <ul style="list-style-type: none"> a) an <i>existing agricultural use</i>; b) an <i>existing</i> club house restricted to an expansion of 100%; c) a <i>public</i> or <i>private park</i>, outdoor track facilities, tennis courts, games played on an outdoor playing field, however, such <i>uses</i> shall not include a bandstand, or an indoor skating arena, or an <i>auditorium</i>, or a place of assembly except for the <i>existing</i> club house; and d) fish and wildlife management. <p>All other requirements of the By-Law shall apply.</p>

SECTION 14: OPEN SPACE (OS) ZONES

By-Law No.	Zone Code	Description
Not Available	OS2-4	Notwithstanding the provisions of this By-Law to the contrary, within any area <i>zoned</i> OS2-4 on Schedule "A" hereto, the permitted <i>uses</i> shall be limited to a <i>park</i> for passive and active recreational <i>uses</i> , to be maintained and operated in a manner similar to the Municipality's management and operation of its municipal <i>parks</i> . This <i>park</i> is to be for the <i>use</i> and enjoyment of the general public. All other requirements of the By-Law shall apply.
59-91, 12-74, 17-81, 54-93, 40-88, 45-96	OS2-5	Notwithstanding the provisions of this By-Law to the contrary, within any area <i>zoned</i> OS2-5 on Schedule "A" hereto, the permitted <i>uses</i> shall be limited to: a) a business involving the manufacturing, fabrication and testing of pavement monitoring and testing equipment and an engineering and consulting business; and b) a tourist oriented business involving boating excursions down the Grand River (Adventures on the Grand). c) Related <i>uses</i> shall include but shall not be limited to an <i>eating establishment</i> (tea room), a <i>retail store</i> , picnic area, outside washroom facilities, and bike rentals. All other requirements of the By-Law shall apply.
228-02	OS2-6	Notwithstanding any provision of this By-Law to the contrary, within any area <i>zoned</i> OS2-6 on Schedule 'A' hereto, a maximum of one (1) <i>accessory dwelling unit</i> located within an <i>accessory structure</i> and <i>used</i> for a security guard or caretaker as required for the operation of the <i>golf course</i> shall be permitted. All other requirements of the By-Law shall apply.
Not Available	OS2-7	Notwithstanding any provision of this By-Law to the contrary, within any area <i>zoned</i> OS2-7 on Schedule "A" hereto, the permitted <i>uses</i> shall be limited to a business involving a miniature golf facility, <i>accessory buildings</i> for a pro-shop and storage area, a putting and practice area and an <i>existing single detached dwelling</i> . The <i>dwelling</i> shall be subject to the regulations of the Agricultural (A) <i>Zone</i> . All other requirements of the By-Law shall apply.

SECTION 14: OPEN SPACE (OS) ZONES

By-Law No.	Zone Code	Description
54-05, 148-06	OS2-8	Notwithstanding any provision of this By-Law to the contrary, within any area <i>zoned</i> OS2-8 on Schedule "A" hereto, the permitted <i>uses</i> shall be limited to a business involving a golf driving range, golf lessons, <i>accessory buildings</i> for a pro-shop and storage area and a putting and practice area. All other requirements of the By-Law shall apply.
131-08	OS2-9	Notwithstanding any provision of this By-Law to the contrary, within any area <i>zoned</i> OS2-9 on Schedule "A" hereto; a) no <i>driveway</i> shall be located in the right (east) <i>side yard</i> of an <i>building</i> , b) a 3.0m landscaped strip shall be provided on the east <i>lot line</i> , c) housing of <i>livestock</i> or <i>poultry</i> shall be limited to the Paris Fair event, and d) all <i>yards</i> shall be measured, and <i>lot coverage</i> calculated, on the basis of the property limits, not internal <i>Zone</i> lines on the <i>lot</i> . All other requirements of the By-Law shall apply.
7-11	OS2-10	Notwithstanding the provisions of this By-Law to the contrary, within any area <i>zoned</i> OS2-10 on Schedule "A" hereto, the following <i>uses</i> shall be permitted: a) <i>conservation use</i> ; b) <i>forestry use</i> ; c) <i>golf course</i> ; d) <i>assembly hall</i> ; e) <i>fairground</i> ; f) <i>place of worship</i> ; g) <i>public</i> and <i>private parks</i> , including playgrounds, picnic facilities, sports fields, a bowling green and tennis courts; h) <i>public parking area</i> ; i) <i>recreational establishment</i> ; j) recreation or <i>community centre</i> ; k) <i>day care</i> ; l) <i>museum</i> ; and m) <i>accessory use</i> . All other requirements of the By-Law shall apply.
Not Available	OS2-11	Notwithstanding any provisions of this By-Law to the contrary, within any area <i>zoned</i> OS2-11 on Schedule "A" hereto, the permitted <i>uses</i> shall be limited to a <i>driveway</i> to provide access to a nine hole <i>golf course</i> . All other requirements of the By-Law shall apply.

SECTION 14: OPEN SPACE (OS) ZONES

By-Law No.	Zone Code	Description
Not Available	OS2-12	<p>Notwithstanding any provision in the By-Law to the contrary, within any area <i>zoned</i> OS2-12 on Schedule “A” hereto, the <i>uses</i> permitted shall be:</p> <ul style="list-style-type: none">a) a <i>private</i> camp for children and youth in <i>dormitory</i> style housing,b) common meeting and dining facilities,c) a second <i>dwelling unit</i>, andd) a non-profit storage <i>building</i> with a maximum <i>floor area</i> of 1,025 square metres, to be <i>used</i> for the collection and distribution of publications and materials <i>used</i> in mission work. <p>Without limiting the generality, the materials <i>used</i> for mission work may include such things as: medical supplies and equipment, educational materials and equipment, publications, bicycles, computers, sewing machines, musical instruments, generators, tools, dry goods, farm equipment, non-perishable food, office supplies and equipment and similar goods to be <i>used</i> in mission work. The minimum requirement for <i>landscaped open space</i> shall be 60%.</p> <p>All other requirements of the By-Law shall apply.</p>

SECTION 14: OPEN SPACE (OS) ZONES

14.7 Special Exceptions OS3 Zone

By-Law No.	Zone Code	Description
Not Available	OS3-1	Notwithstanding the provisions of this By-Law to the contrary, within any area <i>zoned</i> OS3-1 on Schedule "A" hereto, the permitted <i>uses</i> shall be limited to a maximum of 85 <i>campsites</i> to be <i>used</i> for <i>recreational vehicles</i> and 15 <i>campsites</i> to be <i>used</i> for the accommodation of tents. Such <i>use</i> shall only be occupied between May 1 st and October 15 th in any given calendar year. All other requirements of the By-Law shall apply.
205-06, 39-12	OS3-2	Notwithstanding any provision of this By-Law to the contrary, within any area <i>zoned</i> OS3-2 on Schedule "A" hereto, the permitted <i>uses</i> shall be limited to 85 <i>trailer</i> sites, which may be occupied only between March 1st and January 31st, inclusive and which must be unoccupied between February 1st and February 28th or February 29, inclusive, and one (1) <i>single detached dwelling</i> which may be occupied year-round. All other requirements of the By-Law shall apply.
Not Available	OS3-3	Notwithstanding the provisions of this By-Law to the contrary, within any area <i>zoned</i> OS3-3 on Schedule "A" hereto, the maximum number of <i>campsites</i> shall be limited to 400 sites of which 30 <i>campsites</i> may be <i>used</i> for tourist <i>trailers</i> or campers between March 15th and December 15th inclusive, while all other <i>campsites</i> may only be occupied between April 1st to October 31st inclusive in any calendar year. All other requirements of the By-Law shall apply.
Not Available	OS3-4	Notwithstanding the provisions of this By-Law to the contrary, within any area <i>zoned</i> OS3-4 on Schedule "A" hereto, the maximum number of <i>campsites</i> shall be restricted to 300 sites, of which 24 <i>campsites</i> may be <i>used</i> for tourist <i>trailers</i> or campers between March 15th and December 15th inclusive while all other <i>campsites</i> may only be occupied between April 1st to October 31st inclusive in any calendar year. Furthermore, one <i>single dwelling unit</i> and one <i>apartment dwelling unit accessory</i> to the <i>trailer camp</i> or <i>campground</i> shall also be permitted. All other requirements of the By-Law shall apply.
Not Available	OS3-5	Notwithstanding the provisions of this By-Law to the contrary, within any area <i>zoned</i> OS3-5 on Schedule "A" hereto, the maximum number of <i>campsites</i> shall be restricted to 120 sites. Furthermore, a minimum <i>interior side yard</i> of 4 metres shall be provided and any garbage disposal containers shall be located 20 metres from the <i>lot line</i> . All other requirements of the By-Law shall apply.

SECTION 14: OPEN SPACE (OS) ZONES

By-Law No.	Zone Code	Description
Not Available	OS3-6	Notwithstanding the provisions of this By-Law to the contrary, within any area <i>zoned</i> OS3-6 on Schedule "A" hereto, the maximum number of <i>campsites</i> shall be restricted to 318 sites. All other requirements of the By-Law shall apply.
Not Available	OS3-7	Notwithstanding the provisions of this By-Law to the contrary, within any area <i>zoned</i> OS3-7 on Schedule "A" hereto, no <i>buildings</i> or <i>structures</i> shall be <i>erected</i> and the lands may only be <i>used</i> for active recreation purposes such as baseball or soccer playing fields. All baseball nets shall be <i>erected</i> within 20 metres of the north end of the lands. In addition, the lands shall not be <i>used</i> for entertainment purposes such as a band shell or a place where bands may play or perform. All other requirements of the By-Law shall apply.
Not Available	OS3-8	Notwithstanding the provisions of this By-Law to the contrary, within any area <i>zoned</i> OS3-8 on Schedule "A" hereto, the <i>uses</i> and regulations are as follows: (i) Permitted <i>uses</i> shall be limited to a) two (2) <i>dwelling units</i> , b) 220 <i>seasonal dwellings</i> or <i>cottages</i> , c) 110 tent and/or <i>trailer</i> camping sites, d) an administrative office, e) an <i>auditorium</i> and service <i>buildings</i> , f) recreational <i>uses</i> including playing fields, a <i>golf course</i> , swimming and/or wading pools, tennis courts, volleyball courts, basketball courts, <i>studios</i> and/or workshops or similar recreational <i>uses</i> for the <i>use</i> of the occupants of the <i>private park</i> . (ii) The 220 <i>seasonal dwellings/cottages</i> shall be limited in size as follows: - 50 <i>seasonal dwellings/cottages</i> at 90m ² maximum - 40 <i>seasonal dwellings/cottages</i> at 80m ² maximum - 23 <i>seasonal dwellings/cottages</i> at 75m ² maximum - 107 <i>seasonal dwellings/cottages</i> at 47m ² maximum. (iii) Each <i>seasonal dwelling/cottage</i> and <i>trailer/camping</i> site shall be a minimum of 148 square metres (iv) Each <i>trailer/camping</i> site shall have a minimum of one off- <i>street parking space</i> . (v) An additional 200 off- <i>street parking spaces</i> shall be permitted. All other requirements of the By-Law shall apply.

SECTION 14: OPEN SPACE (OS) ZONES

By-Law No.	Zone Code	Description
Not Available	OS3-9	Notwithstanding the provisions of this By-Law to the contrary, within any area <i>zoned</i> OS3-9 on Schedule “A” hereto, in addition to the <i>uses</i> permitted in the OS3 <i>Zone</i> , a children’s camp with all applicable <i>accessory uses</i> shall be permitted. Furthermore, a maximum of three <i>dwelling units</i> and <i>agricultural uses</i> shall also be permitted. Additional <i>uses</i> shall include docks and canoe storage areas, windmill <i>structures</i> and a weather station. All other requirements of the By-Law shall apply.
Not Available	OS3-10	Notwithstanding the provisions of this By-Law to the contrary, within any area <i>zoned</i> OS3-10 on Schedule “A” hereto, in addition to the <i>uses</i> permitted in the OS3 <i>Zone</i> , two single detached dwellings accessory to the <i>recreational trailer park</i> shall also be <i>permitted</i> . Furthermore, the minimum <i>lot area</i> shall be 4 hectares. All other requirements of the By-Law shall apply.

SECTION 15: HOLDING (h) AND TEMPORARY (T) ZONES

15.1 Holding “h” Zone Provisions

Where the symbol “h” appears on a zoning map as a prefix to any *Zone* symbol, the lands have been placed in a ‘Holding *Zone*’ pursuant to Section 36 of the Planning Act. County may pass a By-Law pursuant to Section 36 of the Planning Act to remove the Holding (h) Symbol, thereby placing the lands in the *Zone* indicated by the *Zone* symbol.

While the “h” is in place, the following *uses* shall be permitted:

- a) *Agricultural use*;
- b) conservation;
- c) wildlife and forest management; and
- d) *existing uses*.

For the purposes of this By-Law, the following references constitute the conditions for removal of the holding (h) symbol:

- a) h To ensure the orderly *development* of lands and the adequate provision of municipal services, the “h” symbol shall not be removed until an Agreement as required by the Planning Act is entered into for the subject lands with the County.
- b) h-1 To ensure that *development* takes a form compatible with adjacent land *use*, an Area Study shall be required with public consultation in advance of any development proposals including Plans of Subdivision/Condominium being submitted for approval prior to the removal of the “h” symbol.

15.2 Temporary “T” Zone Provisions

Where a *Zone* symbol is preceded by an upper case letter “T”, a hyphen and a number (T-1), the symbol refers to a temporary *use* permission that applies to the lands so zoned. The provisions of this By-Law are modified for the lands to which the temporary *use* permission applies as set out in this section of this By-Law, until the permission granted by the applicable Temporary Use By-Law expires, in accordance with Section 39 of the Planning Act. This *Zone* permits temporary *uses* for a specified period of time after which the Temporary (T-_) *Zone* symbol and text are removed and revert back to the main *Zone*. It is not intended that a temporary *Zone* will permanently establish a *use* on a *lot*.

SECTION 15: HOLDING (h) AND TEMPORARY (T) ZONES

Table 15.2: Temporary Zone Provisions

By-Law No.	Zone Code	Property Address	Description	Date Temporary Use Expire
6-10	T-1	363 Paris Road	In addition to the <i>uses</i> permitted in the Agricultural (A) Zone, a <i>garden suite</i> shall also be permitted, provided that it is removed on or before the expiry date stated herein. All other requirements of the By-Law shall apply.	April 6, 2020
190-02 153-12	T-2	333 Highway #2	In addition to the <i>uses</i> permitted in the Agricultural (A) Zone, a <i>garden suite</i> shall also be permitted, provided that it is removed on or before the expiry date stated herein. All other requirements of the By-Law shall apply.	October 1, 2022
146-05 152-15	T-3	286 McLean School Road	In addition to the <i>uses</i> permitted in the Agricultural (A) Zone, a <i>garden suite</i> shall also be permitted, provided that it is removed on or before the expiry date stated herein. All other requirements of the By-Law shall apply.	September 22, 2025
165-07, 185-07	T-4	32 Lyons Road	In addition to the <i>uses</i> permitted in the Agricultural (A) Zone, a <i>garden suite</i> shall also be permitted within 70 metres of any <i>building</i> , provided that it is removed on or before the expiry date stated herein. All other requirements of the By-Law shall apply.	September 4, 2017

SECTION 15: HOLDING (h) AND TEMPORARY (T) ZONES

By-Law No.	Zone Code	Property Address	Description	Date Temporary Use Expire
228-07	T-5	98 Molson Road	In addition to the <i>uses</i> permitted in the Agricultural (A) Zone, a <i>garden suite</i> shall also be permitted, provided that it is removed on or before the expiry date stated herein. All other requirements of the By-Law shall apply.	December 4, 2017
106-08	T-6	189 Maple Avenue North	In addition to the <i>uses</i> permitted in the Agricultural (A) Zone, a <i>garden suite</i> shall also be permitted, provided that it is removed on or before the expiry date stated herein. All other requirements of the By-Law shall apply.	June 2, 2018
161-08	T-7	1004 Sawmill Road	In addition to the <i>uses</i> permitted in the Agricultural (A) Zone, a <i>garden suite</i> shall also be permitted, provided that it is removed on or before the expiry date stated herein. All other requirements of the By-Law shall apply.	September 2, 2018
22-09	T-8	825 West Dumfries Road	In addition to the <i>uses</i> permitted in the Agricultural (A) Zone, a <i>garden suite</i> shall also be permitted, provided that it is removed on or before the expiry date stated herein. All other requirements of the By-Law shall apply.	March 9, 2019
6-11	T-9	1508 Highway 54	In addition to the <i>uses</i> permitted in the Agricultural (A) Zone, a <i>garden suite</i> shall also be permitted, provided that it is removed on or before the expiry date stated herein. All other requirements of the By-Law shall apply.	January 10, 2021

SECTION 15: HOLDING (h) AND TEMPORARY (T) ZONES

By-Law No.	Zone Code	Property Address	Description	Date Temporary Use Expire
5-11	T-10	29 Brant Mill Road	In addition to the <i>uses</i> permitted in the Agricultural (A) Zone, a <i>garden suite</i> shall also be permitted not less than four (4) metres from the <i>rear lot line</i> , provided that it is removed on or before the expiry date stated herein. All other requirements of the By-Law shall apply.	January 11, 2021
158-11	T-11	620 Middle Townline Road	In addition to the <i>uses</i> permitted in the Special Exception Agricultural (A-13) Zone, a <i>garden suite</i> shall also be permitted, provided that it is removed on or before the expiry date stated herein. All other requirements of the By-Law shall apply.	October 4, 2021
174-11	T-12	197 Howell Road	In addition to the <i>uses</i> permitted in the Agricultural (A) Zone, a <i>garden suite</i> shall also be permitted, provided that it is removed on or before the expiry date stated herein. All other requirements of the By-Law shall apply.	November 1, 2021
177-12	T-13	232 Bethel Road	In addition to the <i>uses</i> permitted in the Agricultural (A) Zone, a <i>garden suite</i> shall also be permitted, provided that it is removed on or before the expiry date stated herein. All other requirements of the By-Law shall apply.	November 6, 2019
159-13	T-14	42 Highway #5	In addition to the <i>uses</i> permitted in the Agricultural (A) Zone, a <i>garden suite</i> shall also be permitted, provided that it is removed on or before the expiry date stated herein. All other requirements of the By-Law shall apply.	August 27, 2033

SECTION 15: HOLDING (h) AND TEMPORARY (T) ZONES

By-Law No.	Zone Code	Property Address	Description	Date Temporary Use Expire
189-13	T-15	325 Highway #2	<p>Notwithstanding any provision of this By-Law to the contrary, within any area zoned T-15 on Schedule "A" hereto, in addition to the uses permitted in the (A) Zone, a music festival may be permitted on these lands subject to the following;</p> <ol style="list-style-type: none"> 1. Duration: Not to exceed four (4) days during the summer months in any calendar year 2. Time: Entertainment performances limited to 12:00h to 22:00h 3. Area: Festival activities shall be confined to approximately the north 300m of the lot. 4. Structures: No permanent buildings and/or structures shall be constructed for the purpose of the music festival. 5. Power: Generators shall not operate before 08:00h or after 18:00h and provided that the use ceases on or before May 6, 2017. <p>All other requirements of the By-Law shall apply.</p>	May 6, 2017
12-14	T-16	562 Bishopsgate Road	<p>In addition to the uses permitted in the Agricultural (A) Zone, a garden suite shall also be permitted, provided that it is removed on or before the expiry date stated herein.</p> <p>All other requirements of the By-Law shall apply.</p>	January 28, 2034

SECTION 15: HOLDING (h) AND TEMPORARY (T) ZONES

By-Law No.	Zone Code	Property Address	Description	Date Temporary Use Expire
68-14	T-17	769 Drumbo Road	In addition to the <i>uses</i> permitted in the Agricultural (A) <i>Zone</i> , a <i>garden suite</i> shall also be permitted, provided that it is removed on or before the expiry date stated herein. All other requirements of the By-Law shall apply.	May 27, 2034
116-14, 127-15	T-18	446 Ninth Concession Road	<p>In addition to the <i>uses</i> permitted in Agricultural (A) <i>Zone</i>, a <i>kennel</i> with a maximum of 18 dogs shall be permitted on the <i>lot</i> provided that it is removed on or before the expiry date stated herein, and the following regulations shall apply:</p> <ul style="list-style-type: none"> a) A maximum of 18 dogs shall be permitted on the <i>lot</i>; b) No dogs shall be permitted to run ‘at large’ as defined by the Animal Control By-Law; c) Doghouses shall be setback a minimum of 60.0 metres from the <i>front lot line</i>, 12.0 metres from the <i>east lot line</i>, and 45.0 metres from the <i>west lot line</i>; d) Each doghouse shall have a lockable door and ventilation; e) All dogs shall be kept inside doghouses/<i>kennel</i> at night, unless deemed improper treatment as determined by the SPCA; f) The Owner shall comply with the Noise By-Law and take every effort to limit noise from barking dogs at 	May 20, 2016

SECTION 15: HOLDING (h) AND TEMPORARY (T) ZONES

By-Law No.	Zone Code	Property Address	Description	Date Temporary Use Expire
			<p>all times;</p> <p>g) The fence on the <i>lot</i> shall be fully insulated for noise mitigation and shall be completed by September 30th, 2015, to the satisfaction of the General Manager of the Development Services Division or his delegate;</p> <p>h) No dogs or dog houses shall be permitted outside the fenced area on any part of the <i>lot</i>.</p> <p>All other requirements of the By-Law shall apply.</p>	
148-14	T-19	744 Glen Morris Road East	In addition to the <i>uses</i> permitted in the Agricultural (A) <i>Zone</i> , a second temporary <i>dwelling</i> , being a farm help house, provided that it is removed on or before the expiry date stated herein. All other requirements of the By-Law shall apply.	October 21, 2017
21-15	T-20	426 Big Creek Road	In addition to the <i>uses</i> permitted in the Agricultural (A) <i>Zone</i> , a <i>garden suite</i> shall also be permitted, provided that it is removed on or before the expiry date stated herein. All other requirements of the By-Law shall apply.	February 17, 2035
56-15	T-21	167 Third Concession Road	In addition to the <i>uses</i> permitted in the Agricultural (A) <i>Zone</i> , a <i>garden suite</i> shall also be permitted, provided that it is removed on or before the expiry date stated herein. All other requirements of the By-Law shall apply.	April 28, 2035

SECTION 15: HOLDING (h) AND TEMPORARY (T) ZONES

By-Law No.	Zone Code	Property Address	Description	Date Temporary Use Expire
76-15	T-22	465 East Quarter Townline Road	In addition to the <i>uses</i> permitted in the Agricultural (A) <i>Zone</i> , a second temporary <i>dwelling</i> , being a farm help house shall also be permitted, provided that it is removed on or before the expiry date stated herein. All other requirements of the By-Law shall apply.	May 26, 2018
197-09	T-23	84 Harrisburg Road	In addition to the <i>uses</i> permitted in the Residential Hamlet (RH) <i>Zone</i> , a maximum of two <i>dwelling units</i> shall also be permitted with one unit in the form of a <i>mobile home</i> provided that such <i>mobile home</i> is removed from the <i>lot</i> on or before the expiry date stated herein. The <i>rear yard setback</i> for the <i>mobile home</i> shall be reduced to no less than 4.9 metres. All other requirements of the By-Law shall apply.	December 1, 2019
205-08	T-24	38 Andrew Street	In addition to the <i>uses</i> permitted in the Residential Singles and Semi (R2) <i>Zone</i> , a <i>garden suite</i> shall also be permitted within an <i>existing accessory building</i> , provided that it is removed on or before the expiry date stated herein. All other requirements of the By-Law shall apply.	November 11, 2018

SECTION 15: HOLDING (h) AND TEMPORARY (T) ZONES

By-Law No.	Zone Code	Property Address	Description	Date Temporary Use Expire
164-08	T-25	226 Burford Delhi Townline Road	In addition to the <i>uses</i> permitted in the Special Exception Agricultural (A-23) <i>Zone</i> , a <i>garden suite</i> shall also be permitted, provided that it is removed on or before the expiry date stated herein. All other requirements of the By-Law shall apply.	September 2, 2018
87-10	T-26	59 King Street	In addition to the <i>uses</i> permitted in the Suburban Residential (SR) <i>Zone</i> , a second temporary <i>dwelling unit</i> being a <i>mobile home</i> shall also be permitted provided that such <i>mobile home</i> is removed from the <i>lot</i> on or before the expiry date stated herein. The <i>mobile home</i> may be sited on the <i>lot</i> no closer than 2.0 metres from any <i>side lot line</i> . All other requirements of the By-Law shall apply.	May 4, 2020
98-12	T-27	289 Seventh Concession Road	In addition to the <i>uses</i> permitted in the Agricultural (A) <i>Zone</i> , a <i>garden suite</i> shall also be permitted, provided that it is removed on or before the expiry date stated herein. All other requirements of the By-Law shall apply.	June 5, 2032
44-15	T-28	90 German School Road	In addition to the <i>uses</i> permitted in the Agricultural (A) <i>Zone</i> , a <i>garden suite</i> shall also be permitted, provided that it is removed on or before the expiry date stated herein. All other requirements of the By-Law shall apply.	February 17, 2035

SECTION 15: HOLDING (h) AND TEMPORARY (T) ZONES

By-Law No.	Zone Code	Property Address	Description	Date Temporary Use Expire
15-14	T-29	22 McDougall Road	In addition to the <i>uses</i> permitted in the Agricultural (A) Zone, a <i>garden suite</i> shall also be permitted, provided that it is removed on or before the expiry date stated herein. All other requirements of the By-Law shall apply.	January 28, 2034
78-15	T-30	429 Norwich Road	In addition to the <i>uses</i> permitted in the Agricultural (A) Zone, a <i>garden suite</i> shall also be permitted, provided that it is removed on or before the expiry date stated herein. All other requirements of the By-Law shall apply.	May 26, 2025
81-15	T-31	452 Bishopsgate Road	In addition to the <i>uses</i> permitted in the Agricultural (A) Zone, a dog boarding and training facility for upto 30 dogs shall also be permitted. All other requirements of the By-Law shall apply.	May 26, 2018
195-15	T-32	743 Glen Morris Road West	In addition to the <i>uses</i> permitted in the Agricultural (A) Zone, an <i>existing garden suite</i> shall also be permitted for a period of three years, provided that it is removed on or before the expiry date stated herein. The structure is to be demolished on or before December 15 th , 2018. All other requirements of the By-Law shall apply.	December 15, 2018

SECTION 15: HOLDING (h) AND TEMPORARY (T) ZONES

By-Law No.	Zone Code	Property Address	Description	Date Temporary Use Expire
141-15	T-33	23 Brant Church Road	In addition to the uses permitted in Agricultural (A) Zone, one (1) temporary second <i>dwelling</i> being a <i>garden suite</i> shall also be permitted provided that the <i>mobile home</i> portion of the <i>dwelling</i> does not exceed a <i>gross floor area</i> of 56.0 square metres, the additional traditional construction portion of the <i>dwelling</i> does not exceed 52.0 square metres, that the total <i>gross floor area</i> of the <i>dwelling</i> does not exceed 108.0 square metres, and the entire temporary second <i>dwelling</i> is removed from the <i>lot</i> on or before the expiry date stated herein. All other requirements of the By-Law shall apply.	September 28, 2018
125-15	T-34	817 Watt's Pond Road	In addition to the uses permitted in the Agricultural (A) Zone, a <i>garden suite</i> shall also be permitted, provided that it is removed on or before the expiry date stated herein. All other requirements of the By-Law shall apply.	August 25, 2035

APPENDIX 1: INTERPRETATION DIAGRAMS

1. Lot Depth

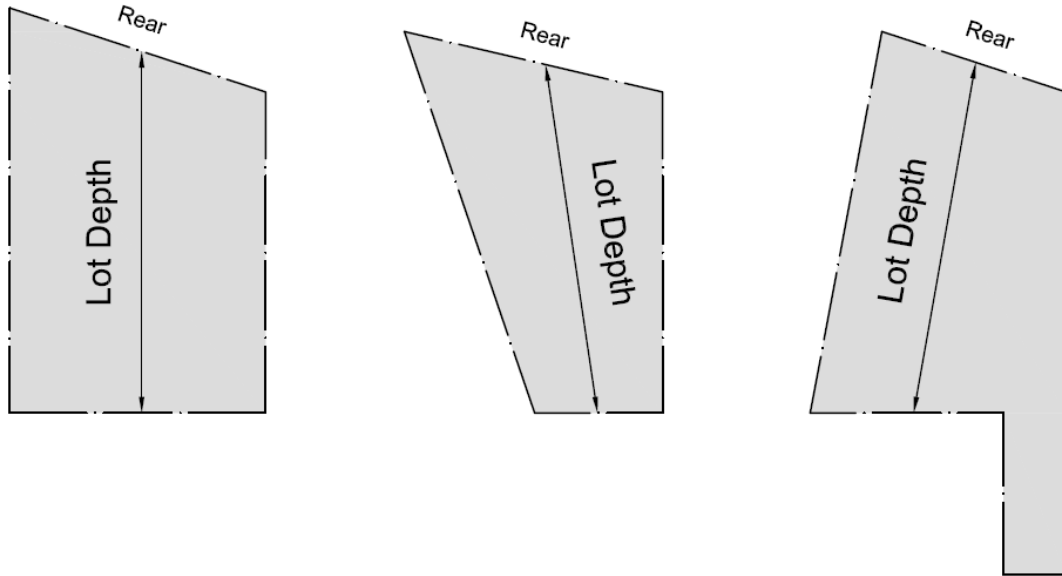

2. Lot Width

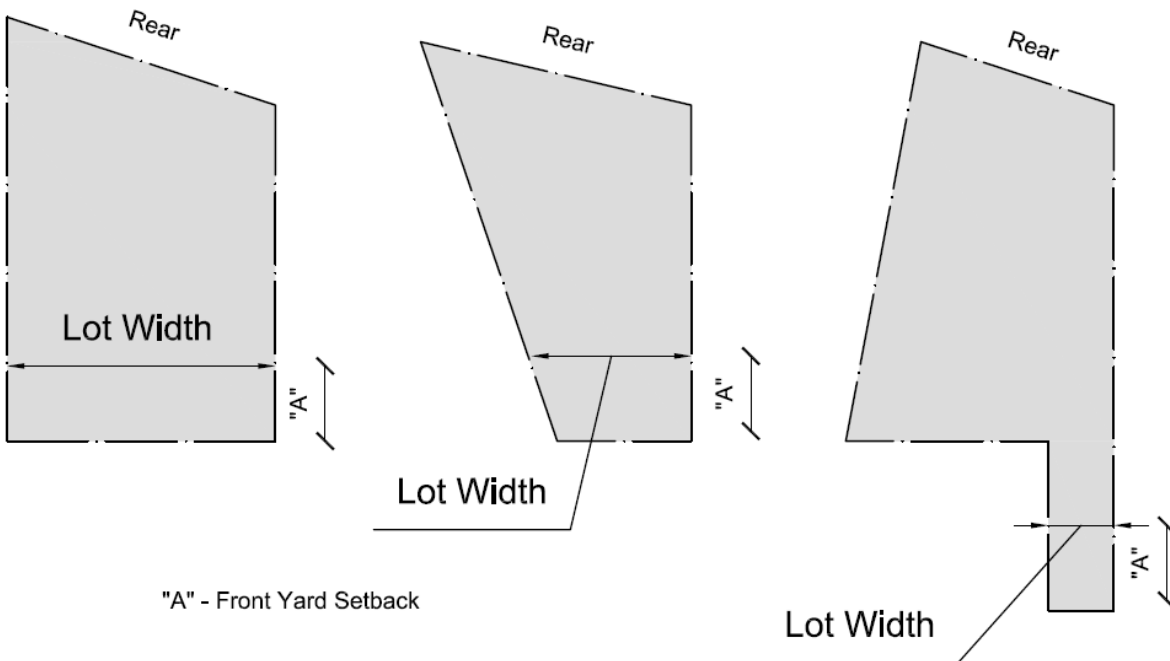

3. Lot Coverage

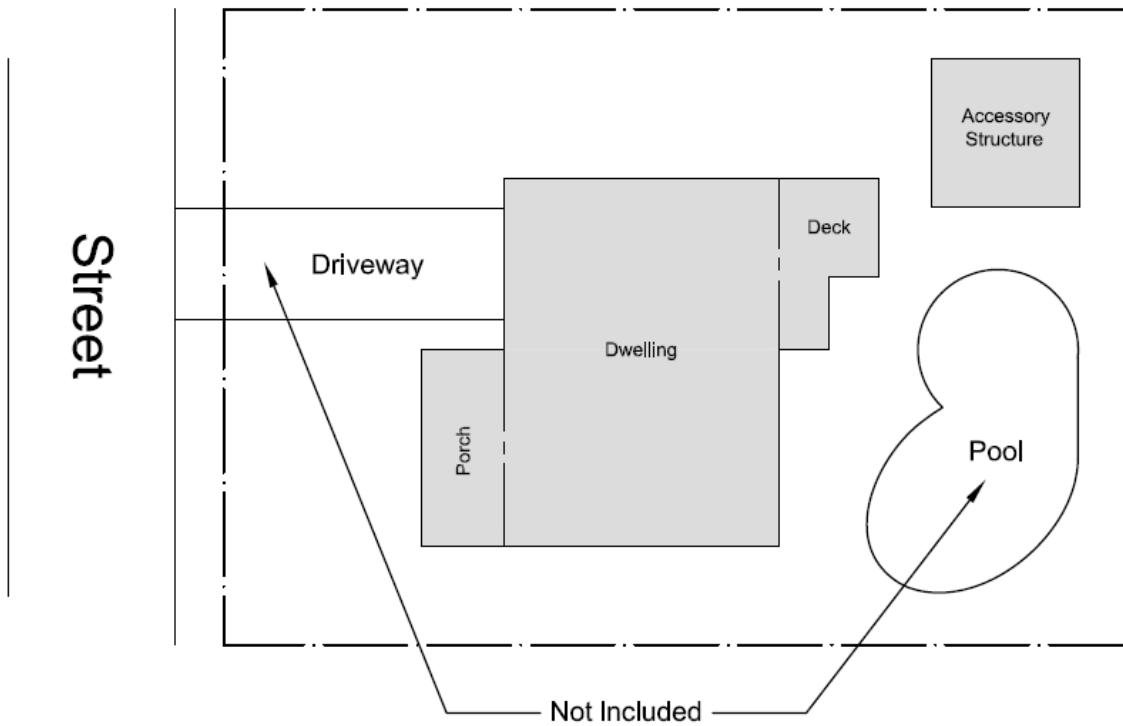

4. Basement

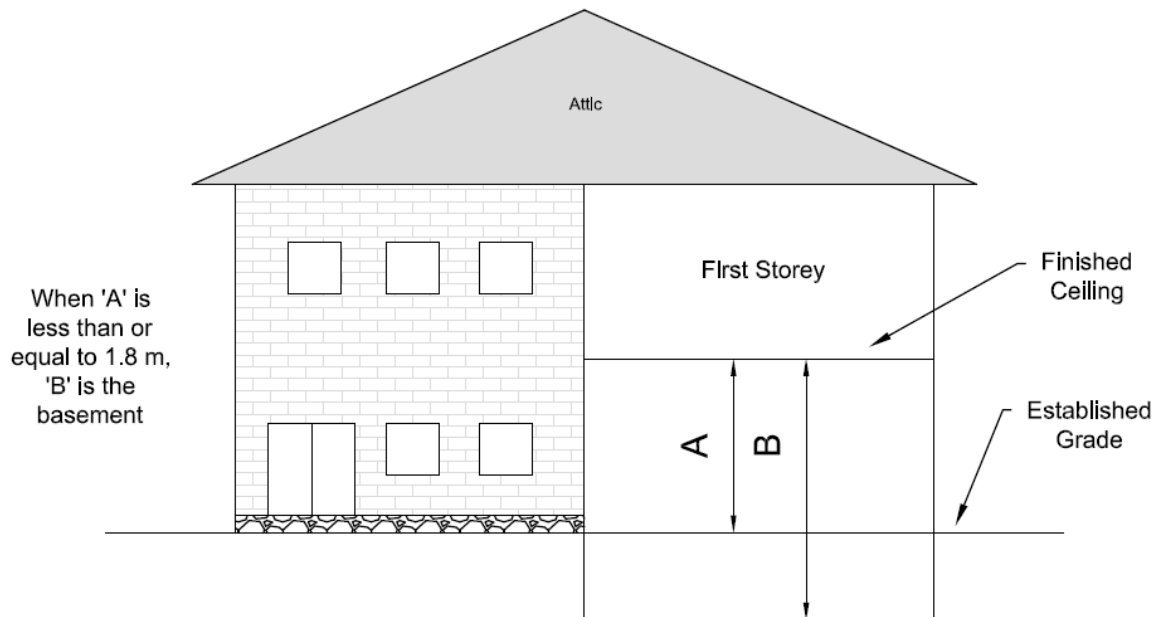

5. Setbacks

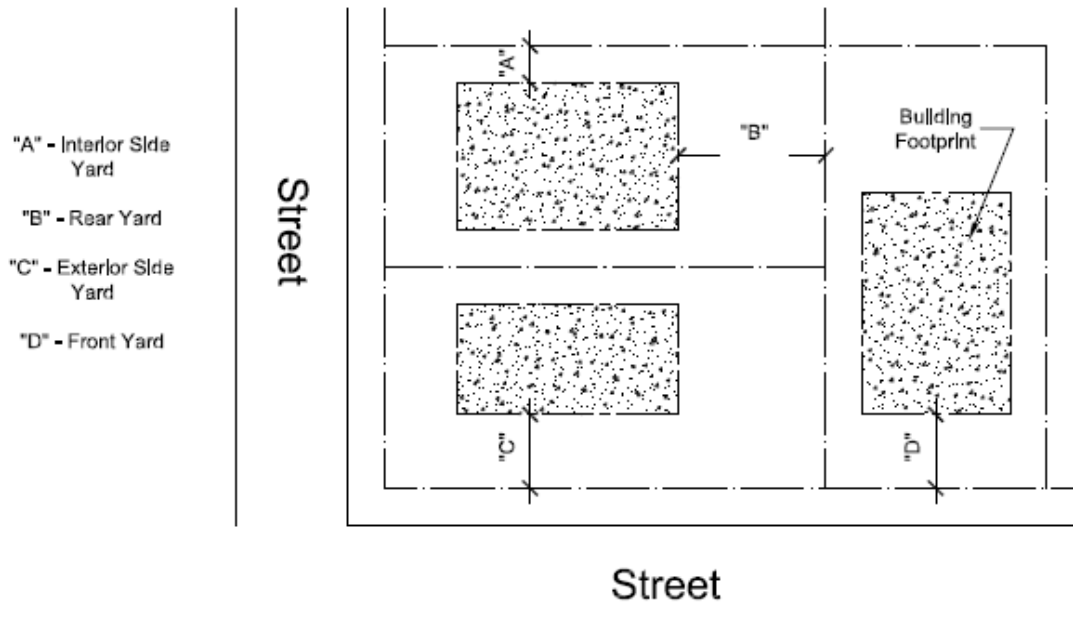

6. Lot Line

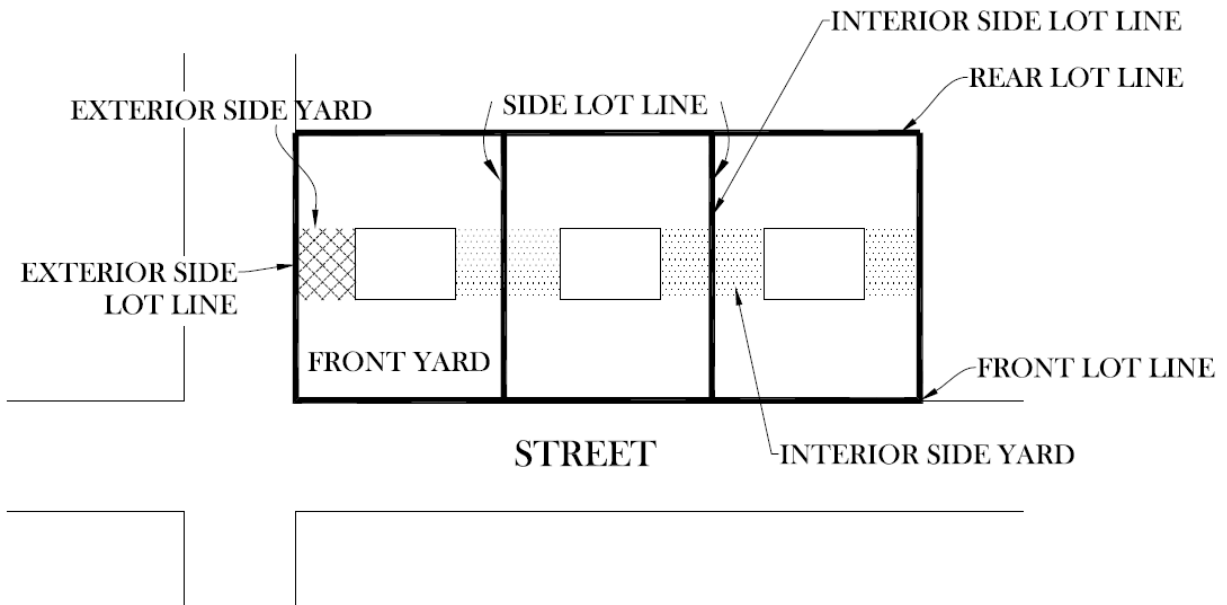

7. Lot Definitions

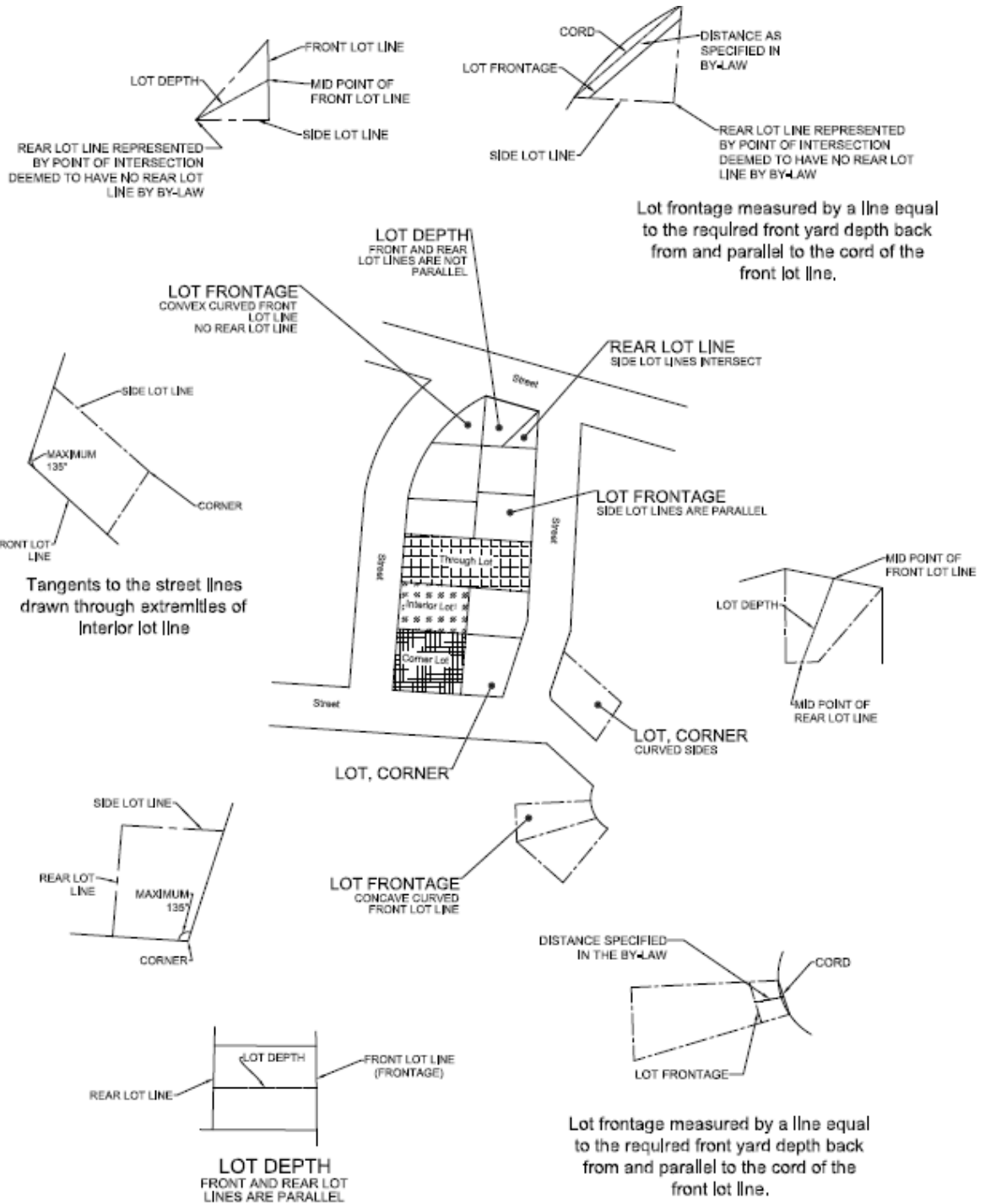

8. Lot Frontage

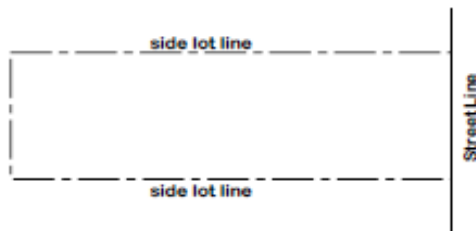

- (A)** SIDE LOT LINES ARE PARALLEL; STREET IS STRAIGHT
the lot frontage is measured along the street line between the side lot lines

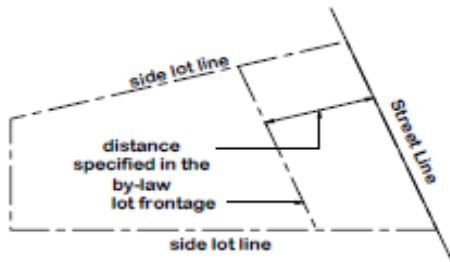

- (B)** FRONT AND REAR LOT LINES ARE NOT PARALLEL
the lot frontage is measured along a line drawn between the side lot lines parallel to the front lot line at the distance specified in the by-law for the minimum front yard

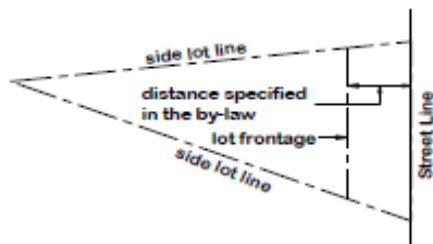

- (C)** NO REAR LOT LINE
the lot frontage is measured along a line drawn between the side lot lines parallel to the front lot line at the distance specified in the by-law for the minimum front yard

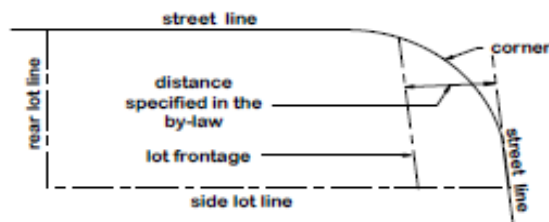

- (D)** CORNER OR INTERIOR LOT ON A CURVE
the lot frontage is measured along a line drawn parallel to the tangent of the front lot line at the distance specified in the by-law for the minimum front yard

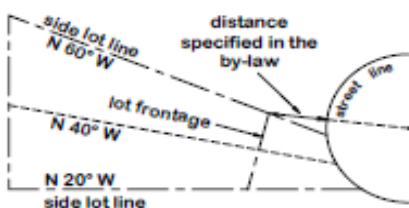

- (E)** LOT ON A CUL-DE-SAC OR EYEBROW
the lot frontage is measured along a line drawn perpendicular to the mean bearing of the side lot lines the radial distance of which line, at its closest point to the street line, is not less than the distance specified in the by-law for the minimum front yard.

9. Dwelling Unit Types

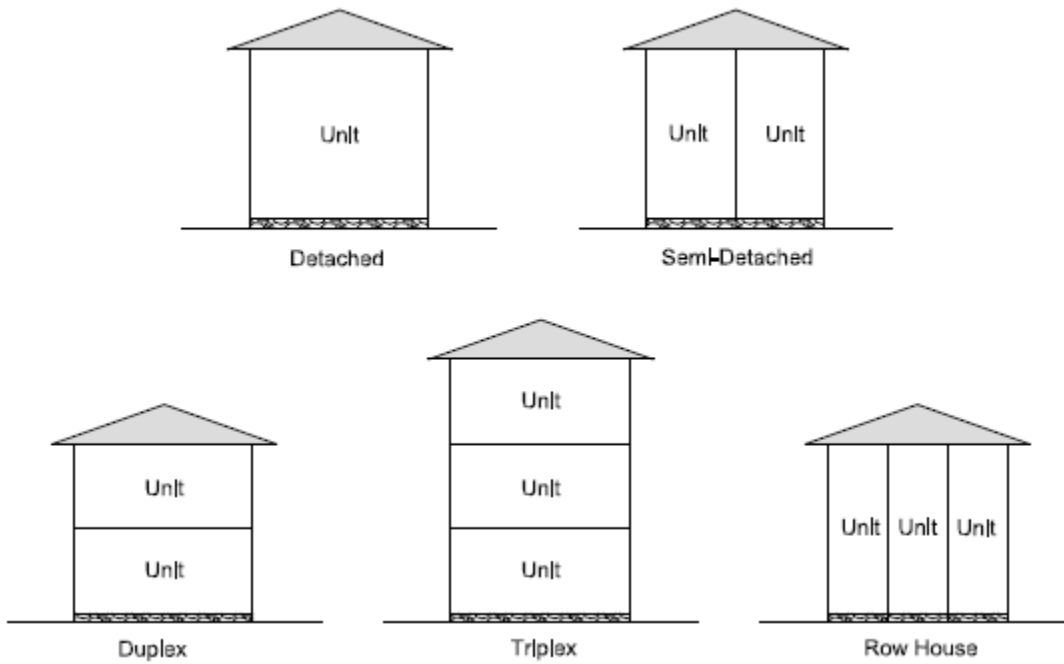

10. Yard Requirements

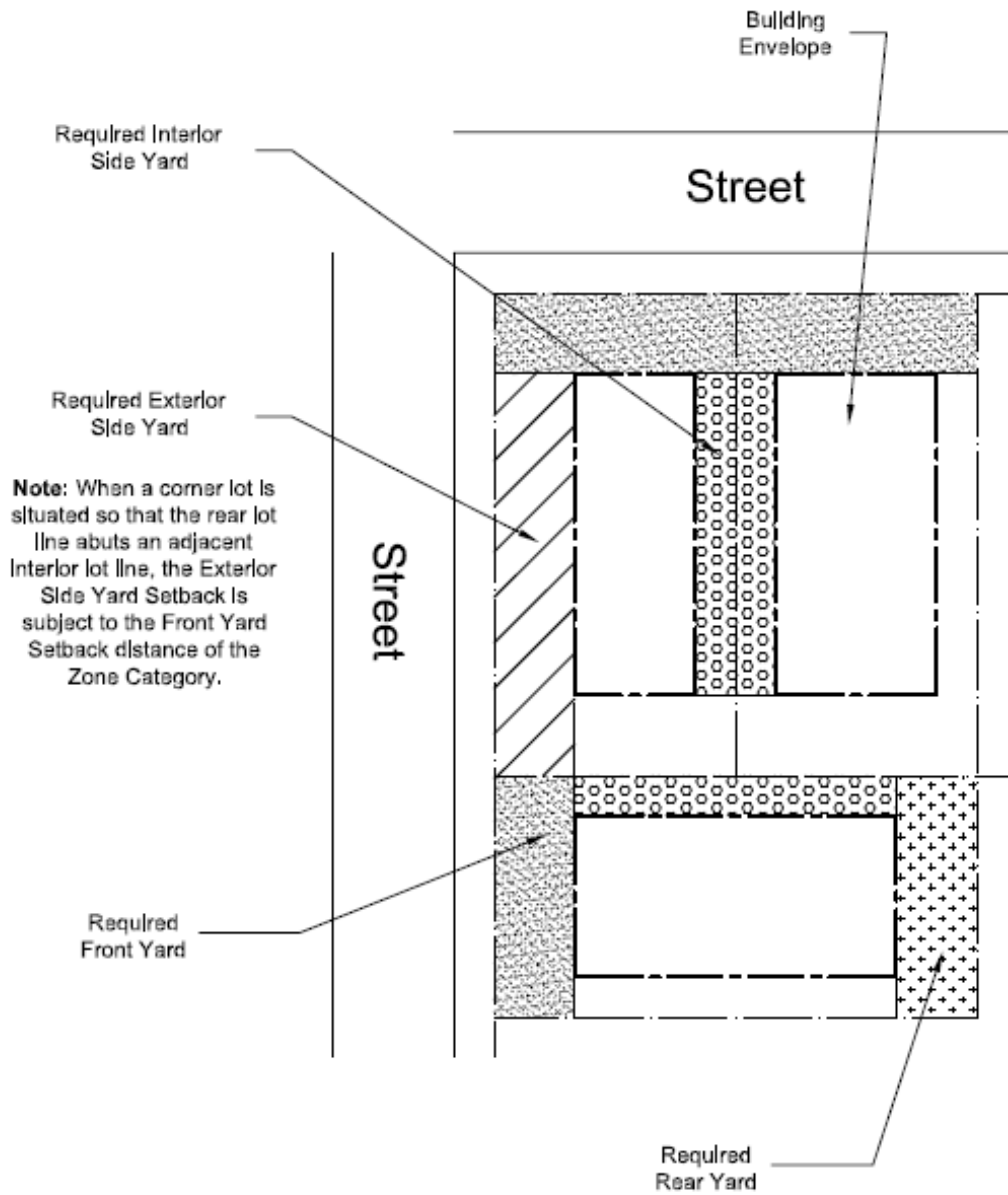

11. Yard Types

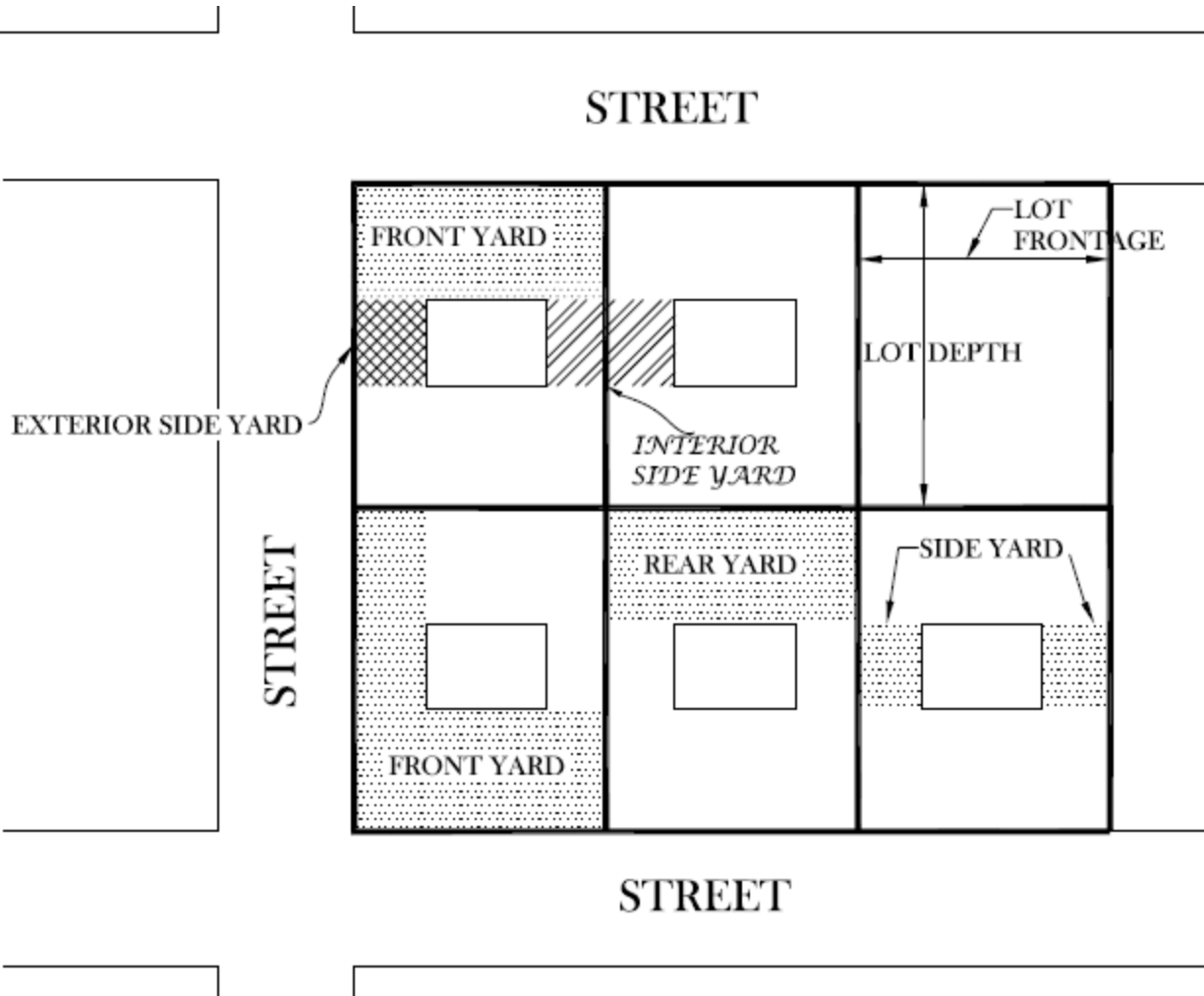

12. Building Height

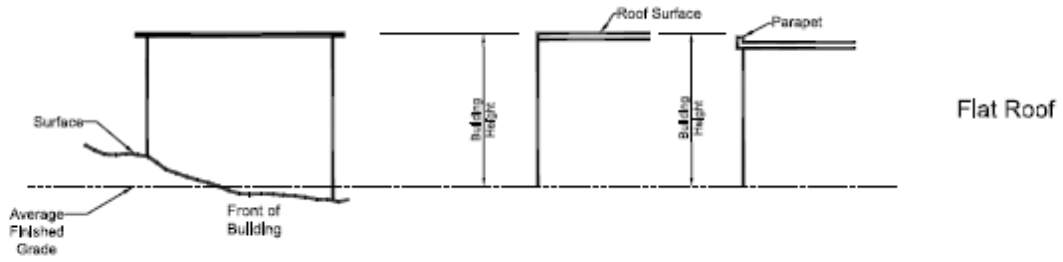

Flat Roof

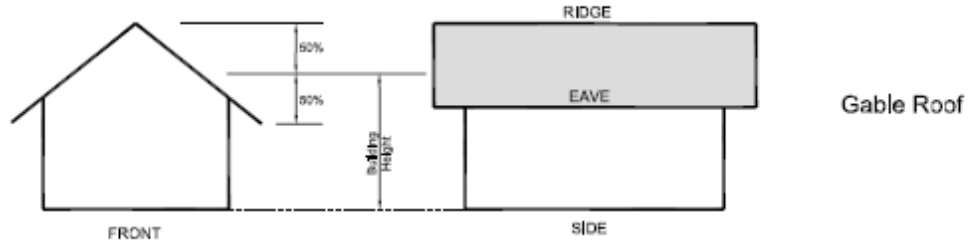

Gable Roof

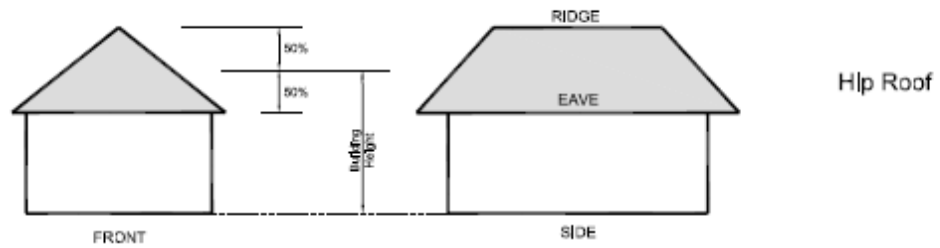

Hip Roof

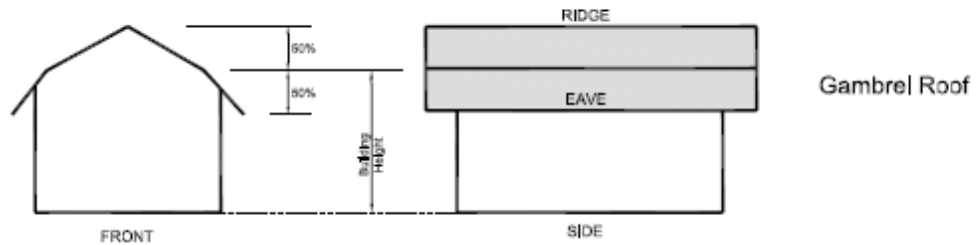

Gambrel Roof

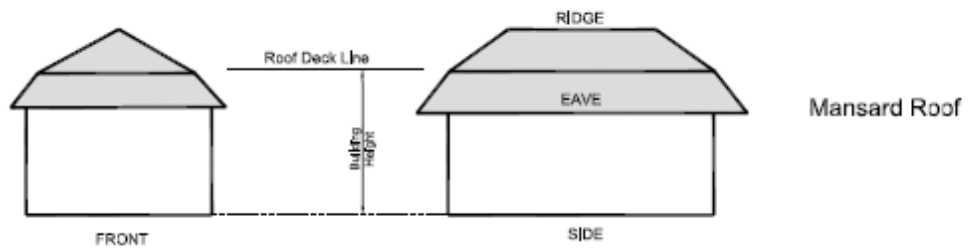

Mansard Roof

13. Parking Lot and Access Driveways

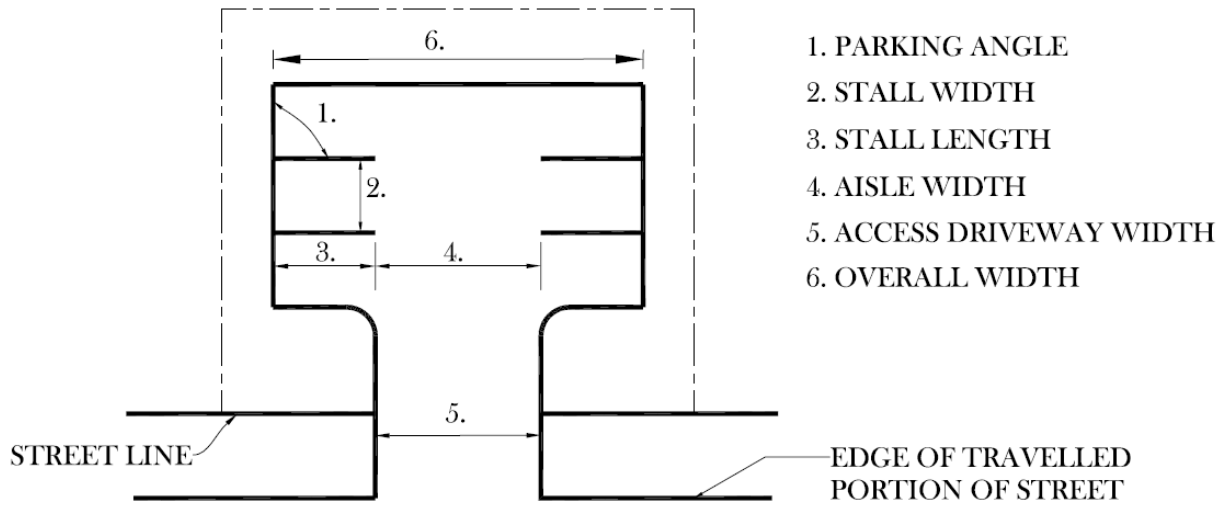

14. Accessible Parking

Angle Parking

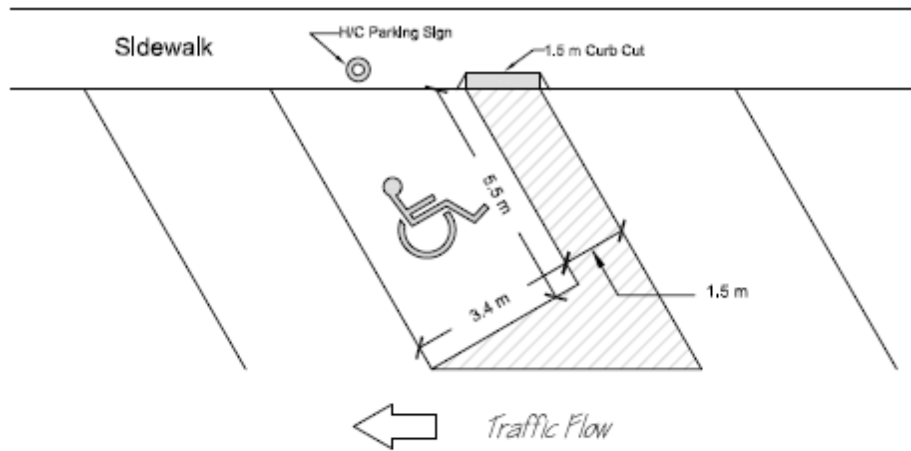

Perpendicular Parking - Type A

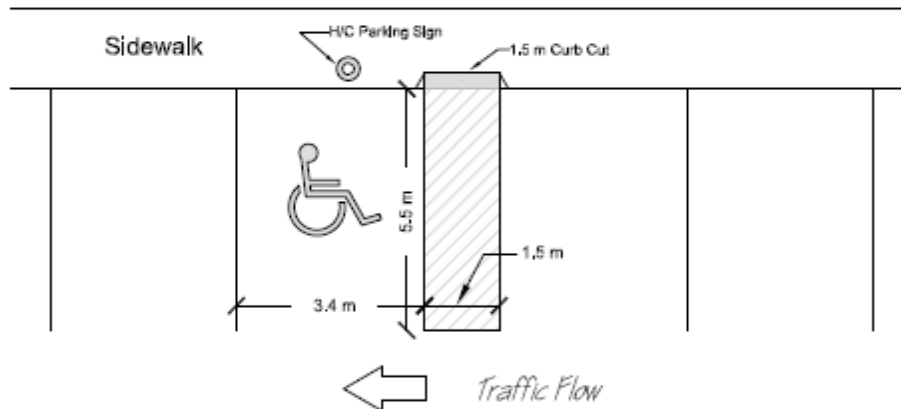

Perpendicular Parking - Type B

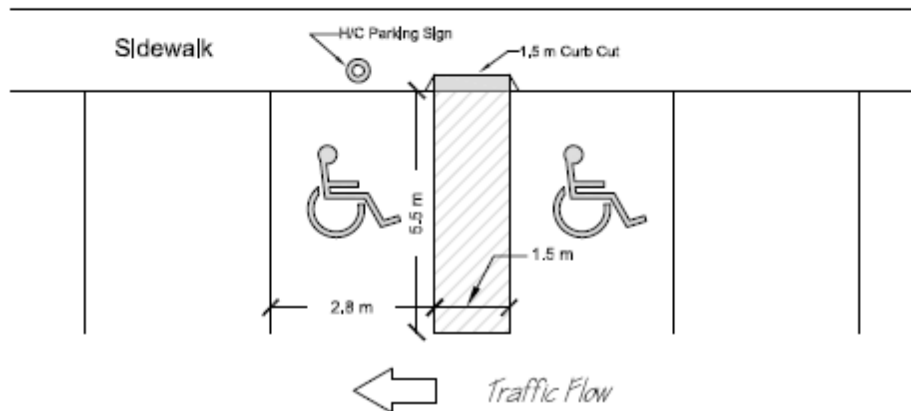

COUNTY OF BRANT

Zoning By-Law Schedule 'A' Key Map

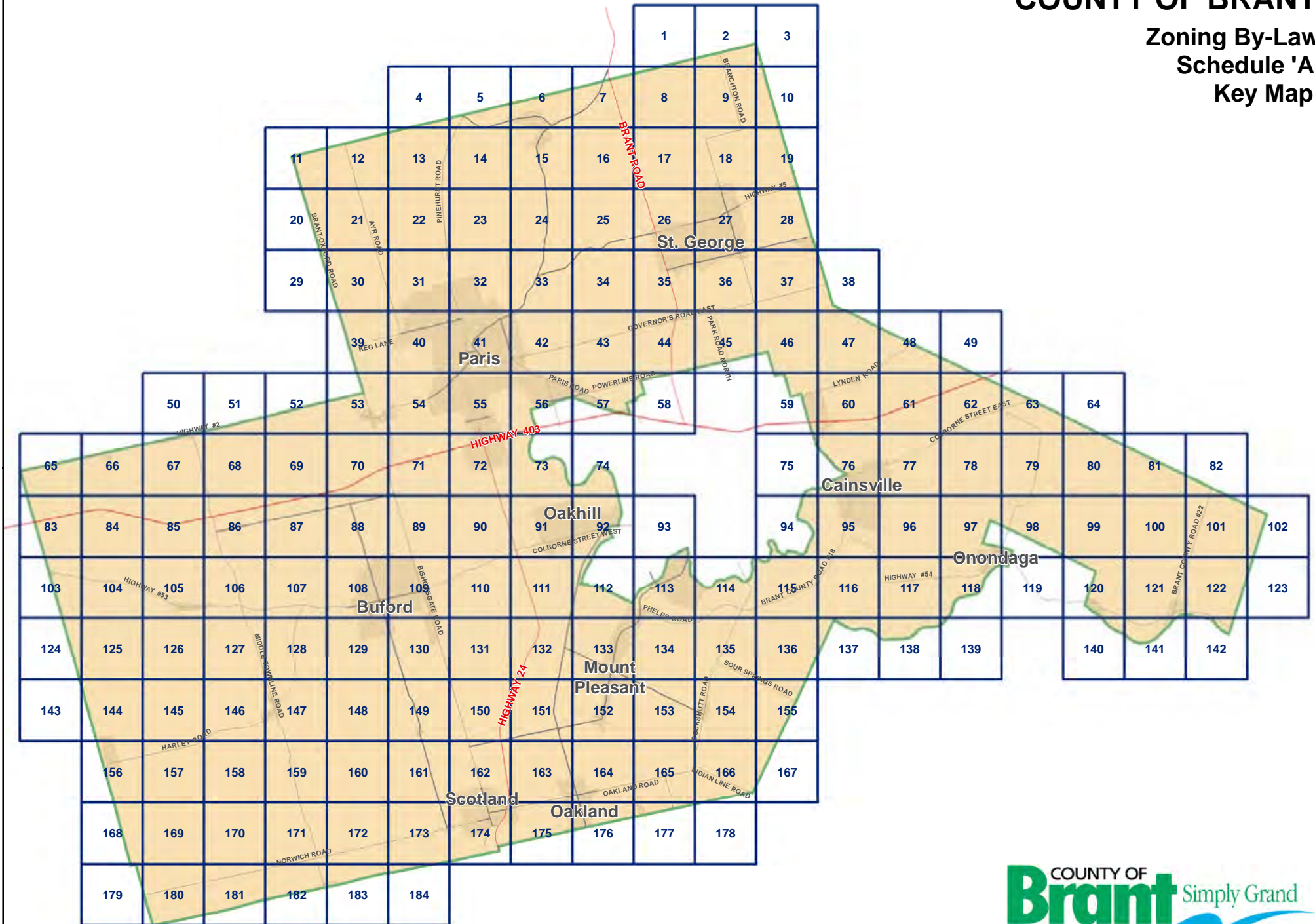

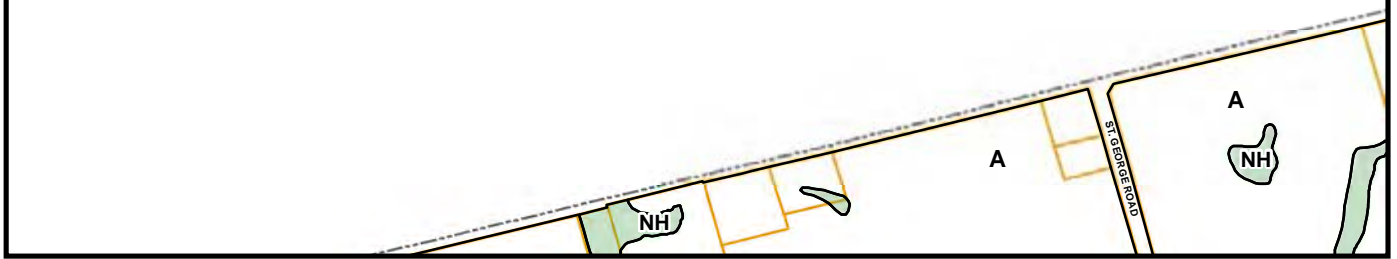

REGIONAL
MUNICIPALITY
OF WATERLOO

2





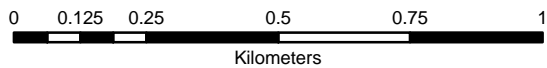

8

ZONING BY-LAW
SCHEDULE 'A'
Map No. 1

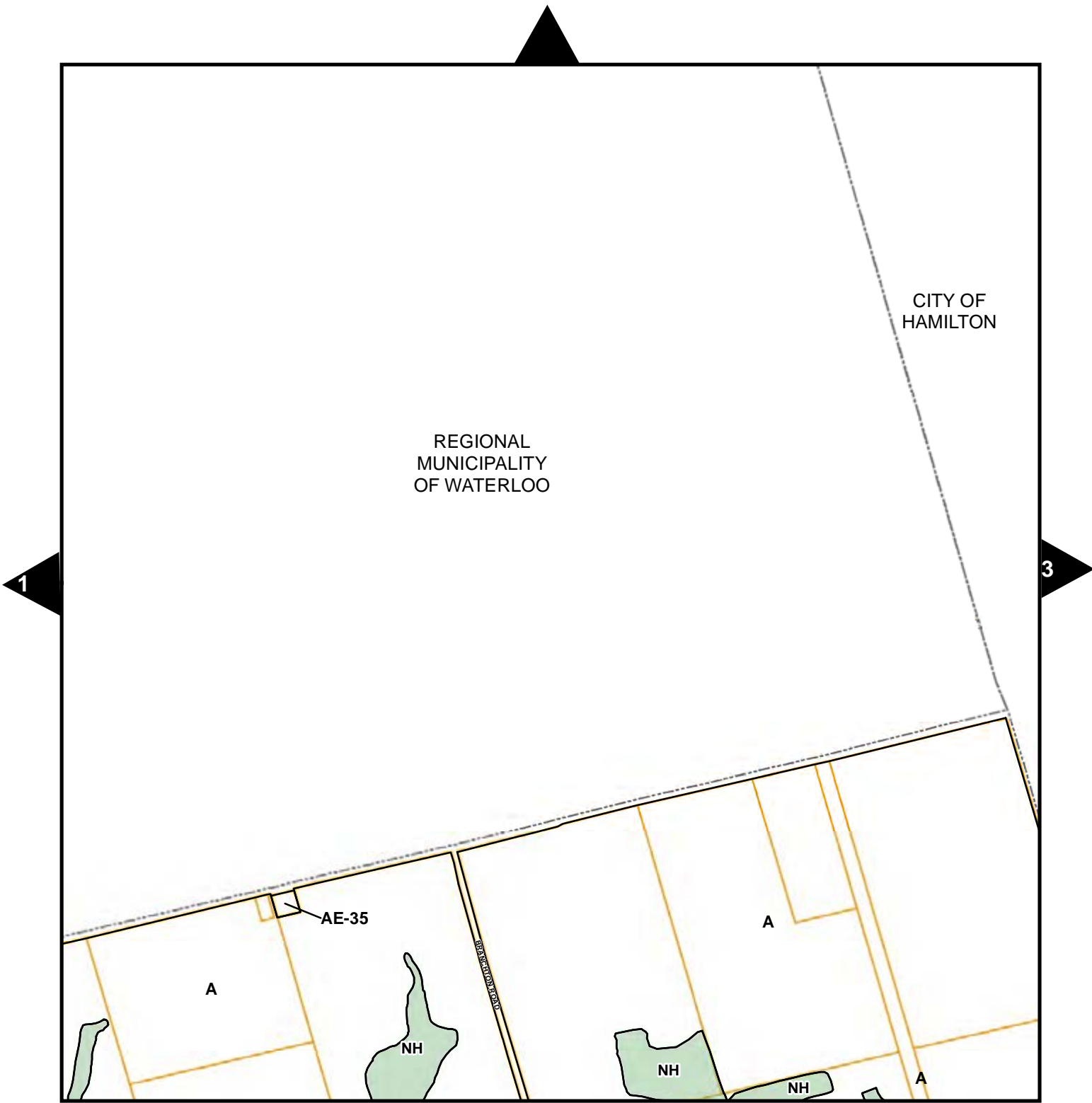
-  Zoning
-  Natural Heritage
-  Parcel Fabric





-  Zoning
-  Natural Heritage
-  Parcel Fabric



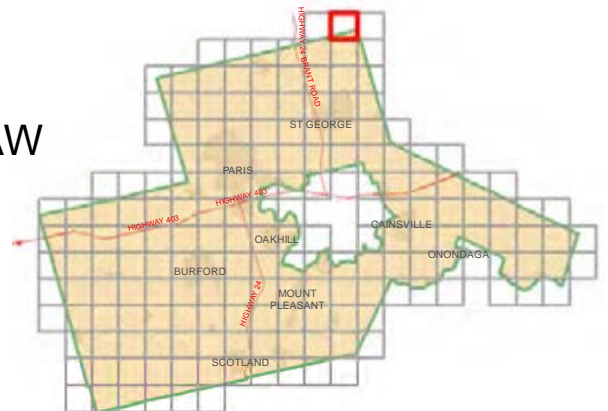

ZONING BY-LAW
SCHEDULE 'A'
Map No. 2



CITY OF
HAMILTON

10



-  Zoning
-  Natural Heritage
-  Parcel Fabric

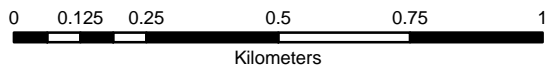

ZONING BY-LAW
SCHEDULE 'A'
Map No. 3



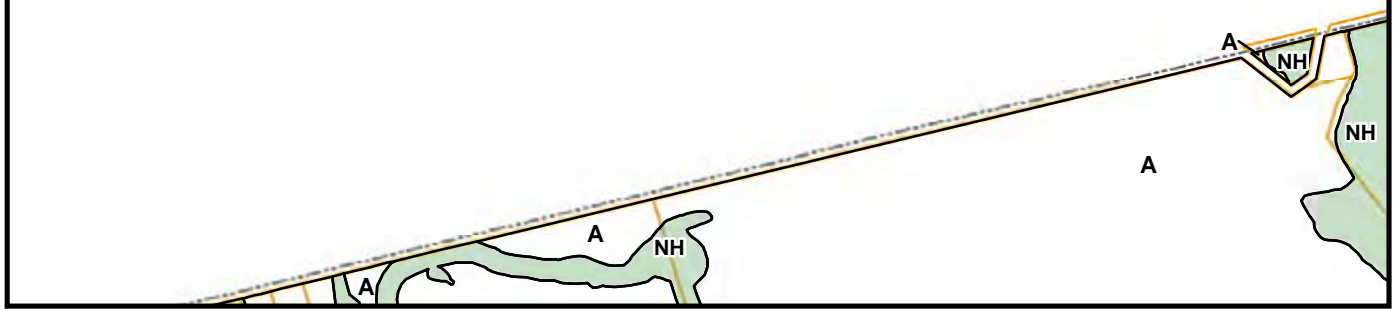

REGIONAL
MUNICIPALITY
OF WATERLOO

5



13





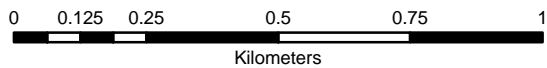

-  Zoning
-  Natural Heritage
-  Parcel Fabric

ZONING BY-LAW
SCHEDULE 'A'
Map No. 4

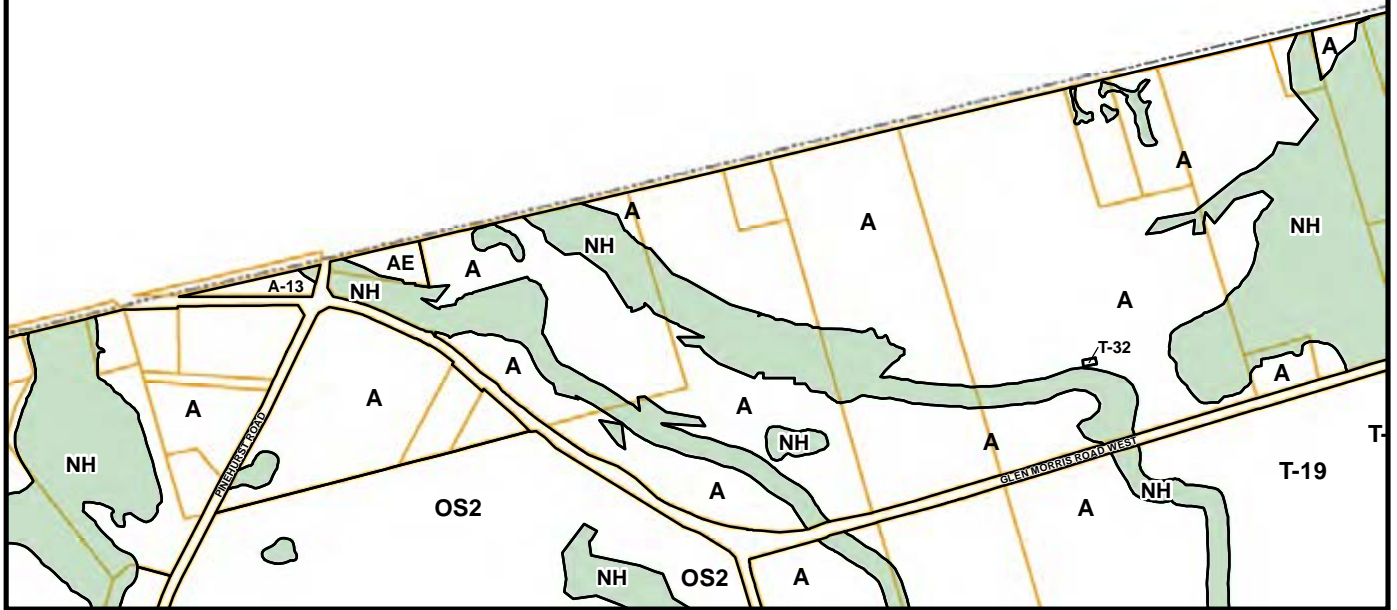

REGIONAL
MUNICIPALITY
OF WATERLOO



-  Zoning
-  Natural Heritage
-  Parcel Fabric

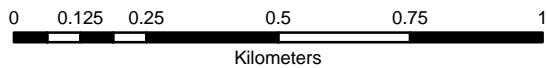

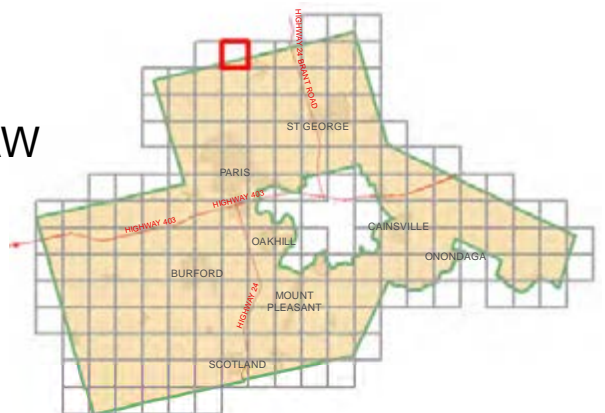

ZONING BY-LAW
SCHEDULE 'A'
Map No. 5



REGIONAL
MUNICIPALITY
OF WATERLOO



ZONING BY-LAW
SCHEDULE 'A'
Map No. 6

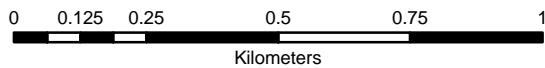

-  Zoning
-  Natural Heritage
-  Parcel Fabric



REGIONAL
MUNICIPALITY
OF WATERLOO



ZONING BY-LAW
SCHEDULE 'A'
Map No. 7

-  Zoning
-  Natural Heritage
-  Parcel Fabric

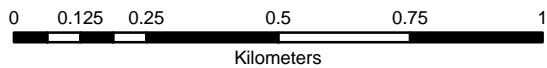

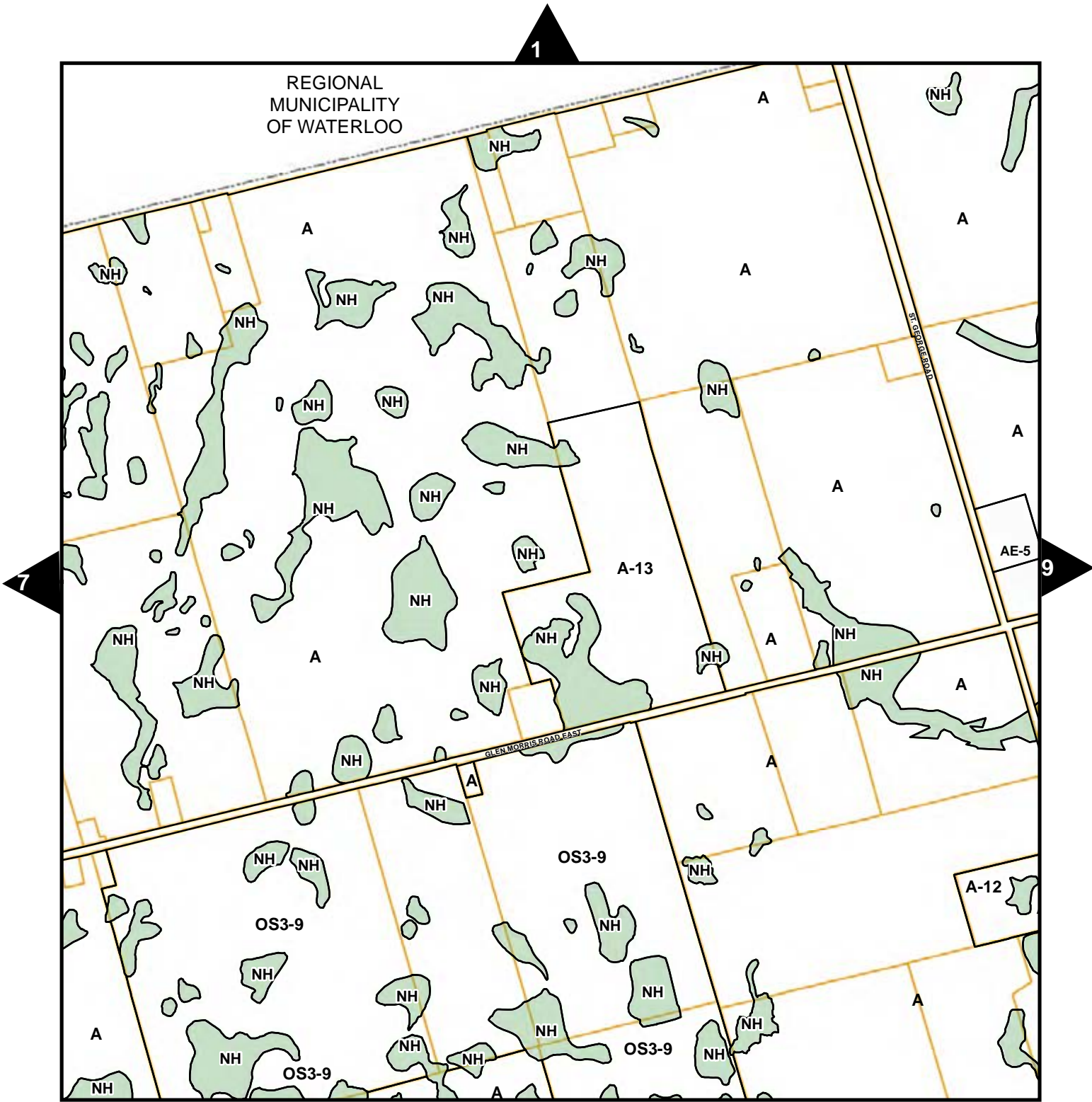

- Zoning
- Natural Heritage
- Parcel Fabric

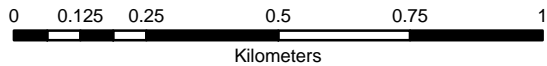

ZONING BY-LAW

SCHEDULE 'A'

Map No. 8

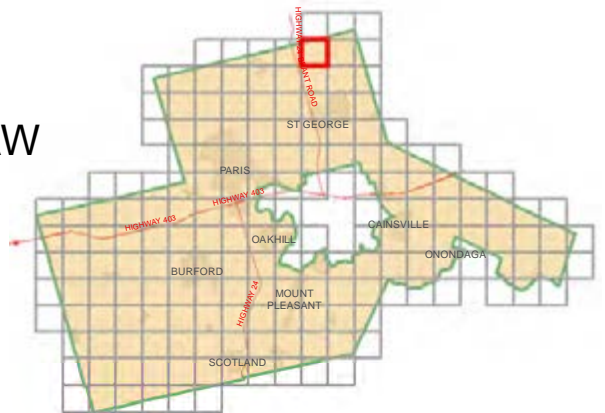

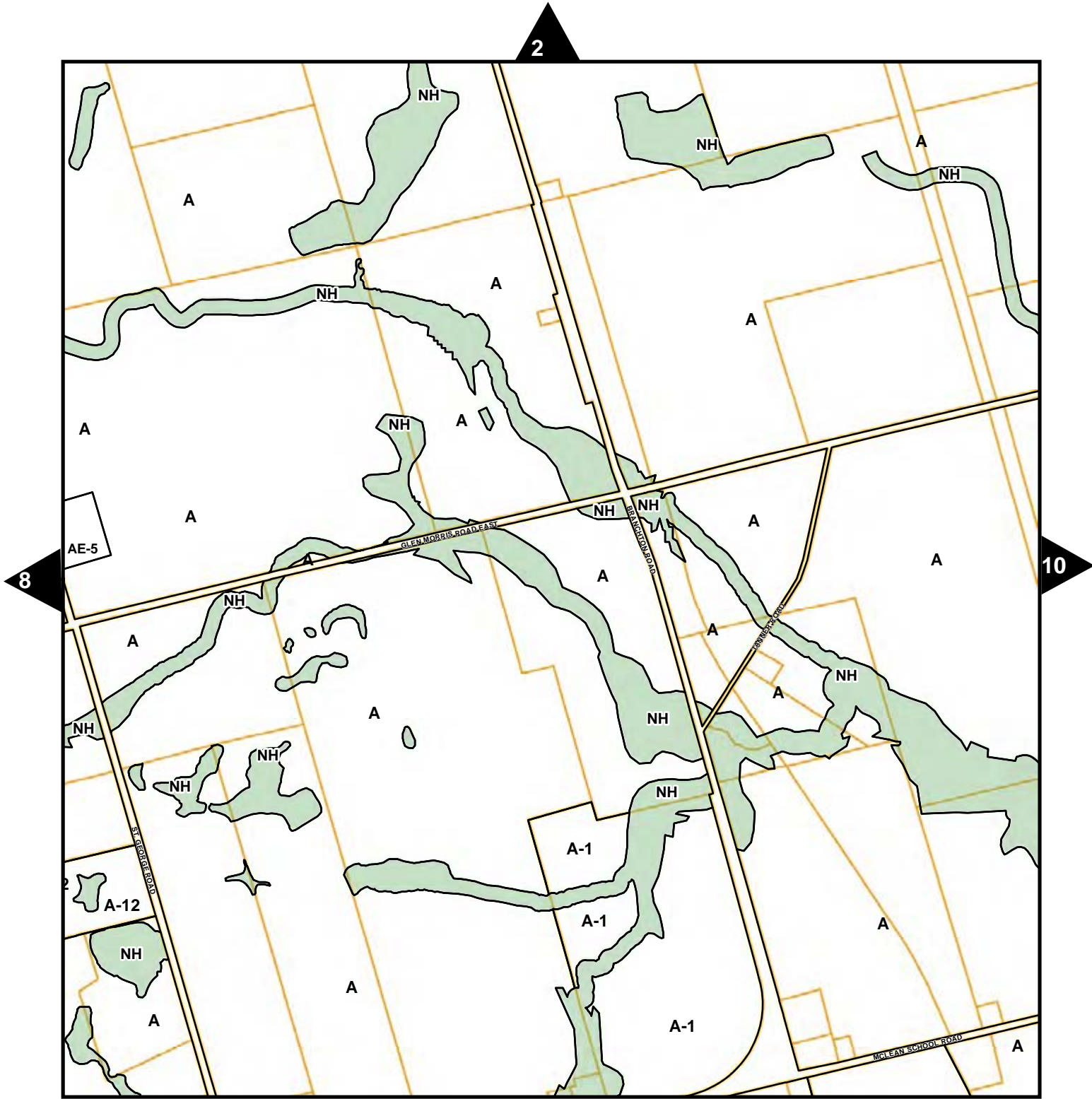





- Zoning
- Natural Heritage
- Parcel Fabric

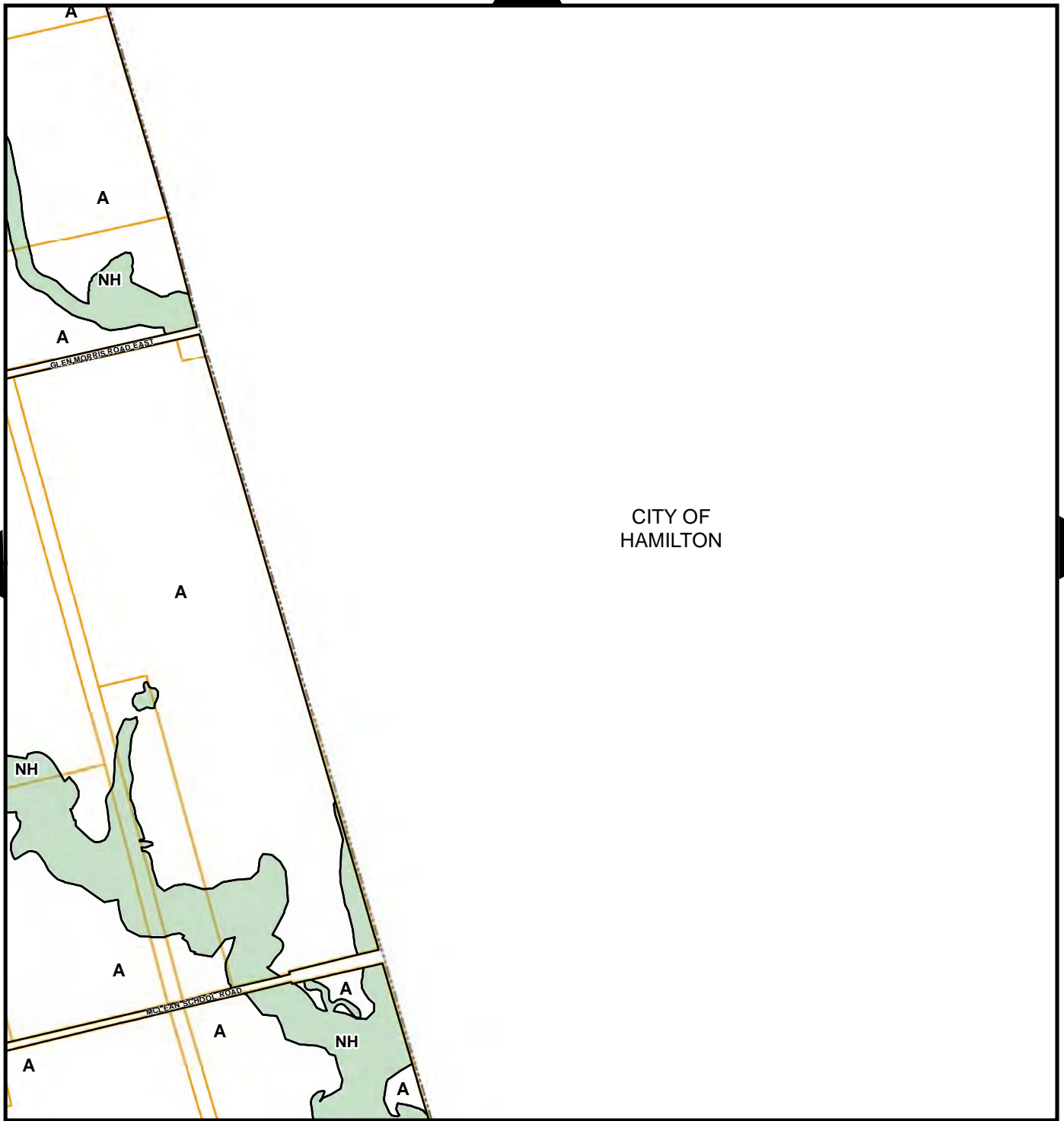

ZONING BY-LAW
SCHEDULE 'A'
Map No. 9





-  Zoning
-  Natural Heritage
-  Parcel Fabric

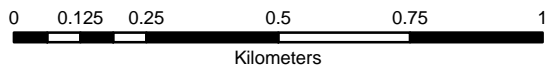

ZONING BY-LAW
SCHEDULE 'A'
Map No. 10





- Zoning
- Natural Heritage
- Parcel Fabric

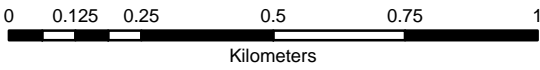

ZONING BY-LAW
SCHEDULE 'A'
Map No. 11



20

12

REGIONAL
MUNICIPALITY
OF WATERLOO

11

13

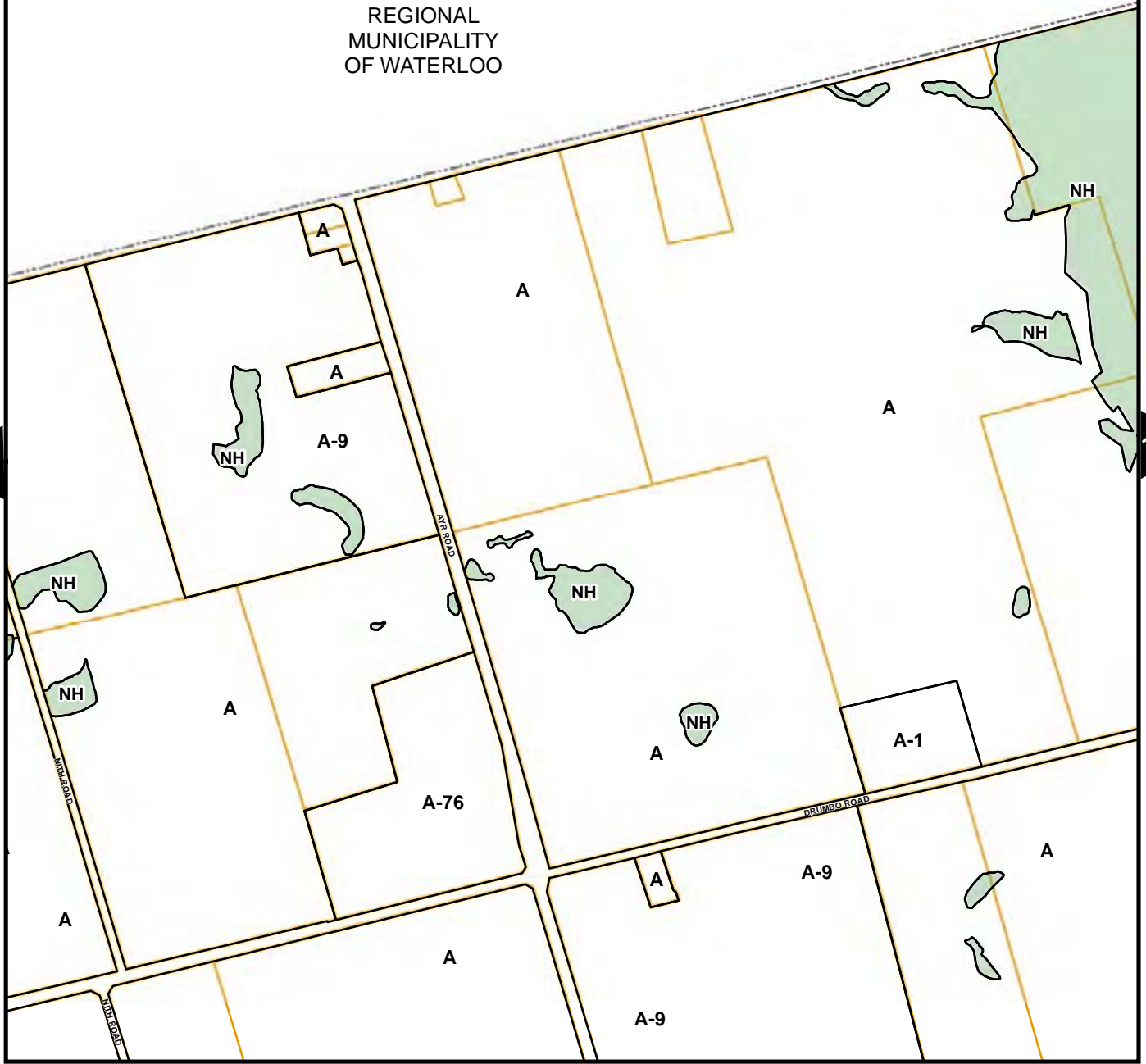

21



- Zoning
- Natural Heritage
- Parcel Fabric

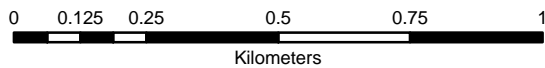

ZONING BY-LAW
SCHEDULE 'A'
Map No. 12

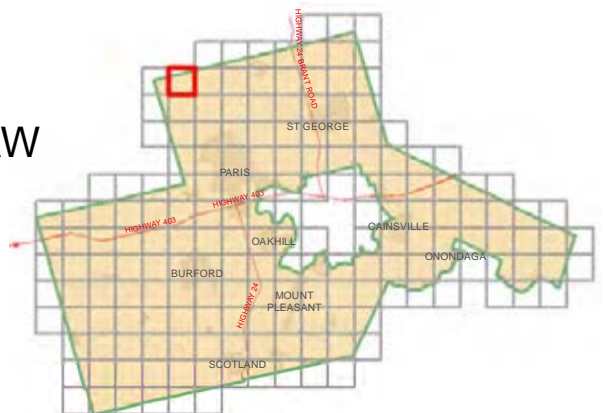

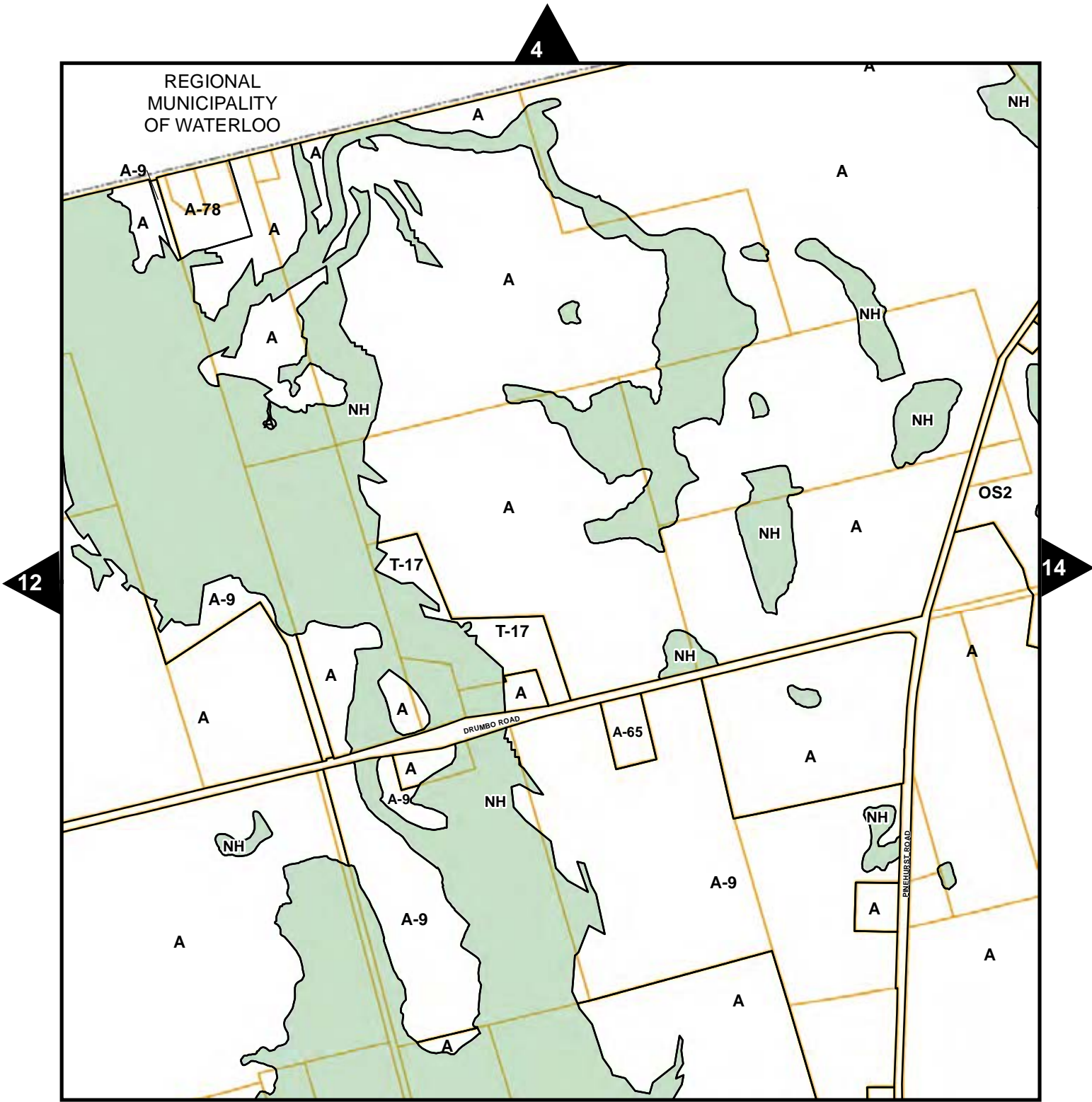

- Zoning
- Natural Heritage
- Parcel Fabric

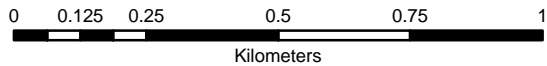

ZONING BY-LAW SCHEDULE 'A' Map No. 13



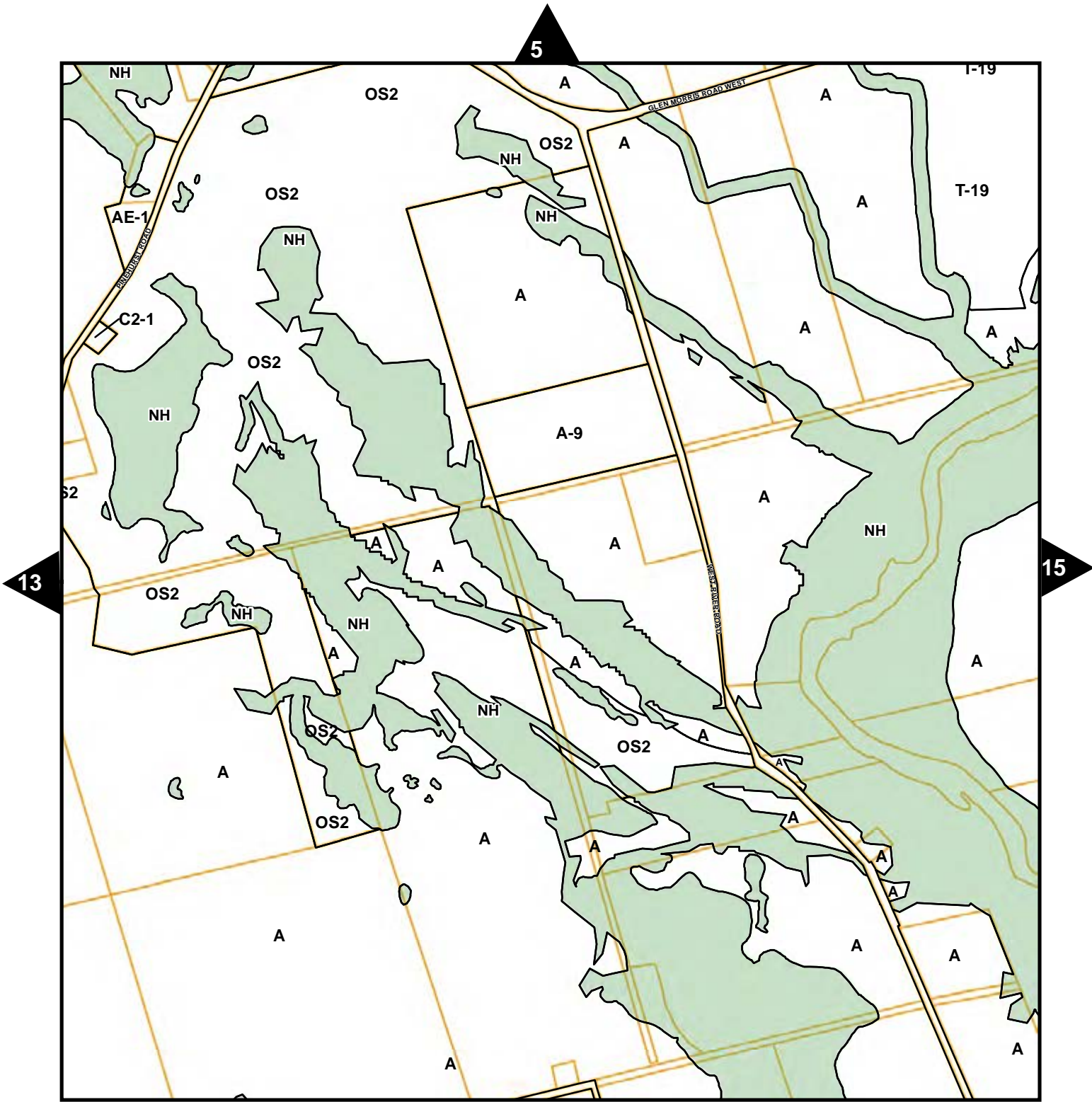





- Zoning
- Natural Heritage
- Parcel Fabric

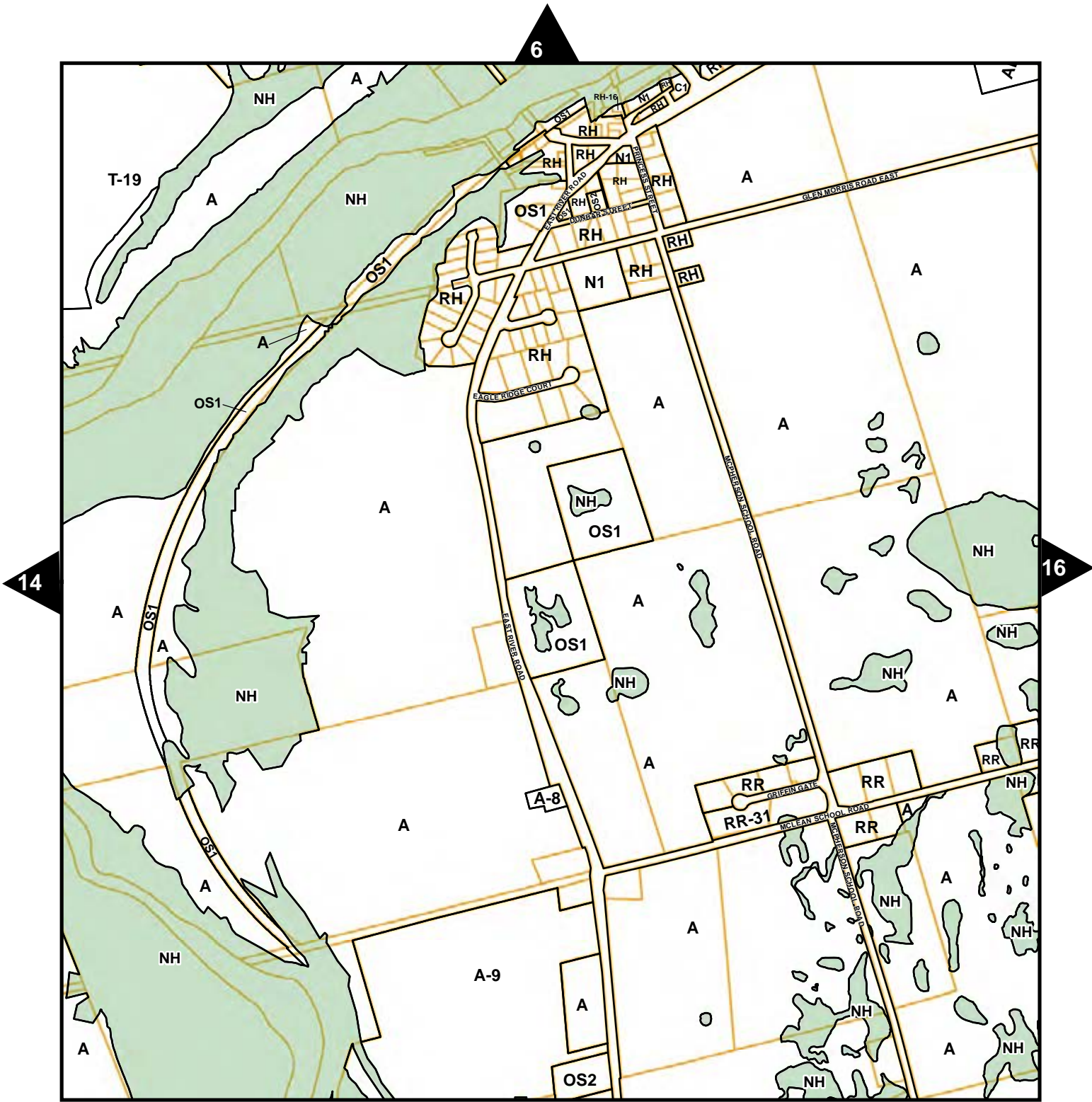

ZONING BY-LAW
SCHEDULE 'A'
Map No. 14





-  Zoning
-  Natural Heritage
-  Parcel Fabric



ZONING BY-LAW SCHEDULE 'A' Map No. 15

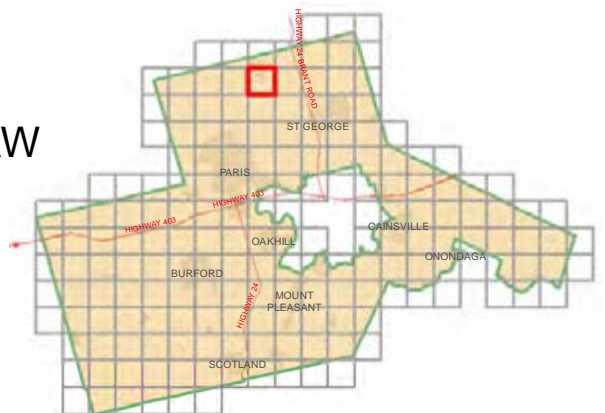

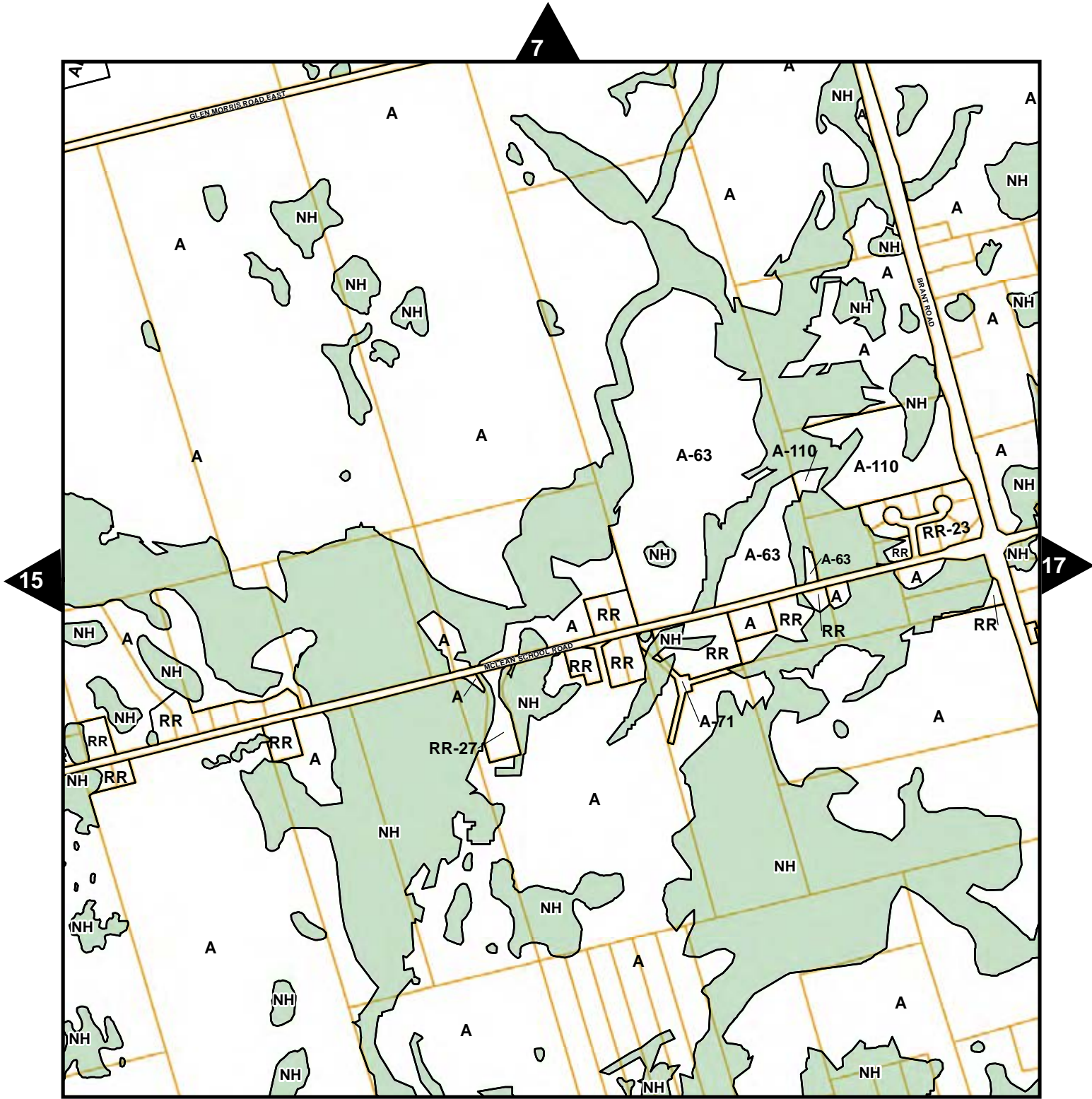

- Zoning
- Natural Heritage
- Parcel Fabric



ZONING BY-LAW SCHEDULE 'A' Map No. 16

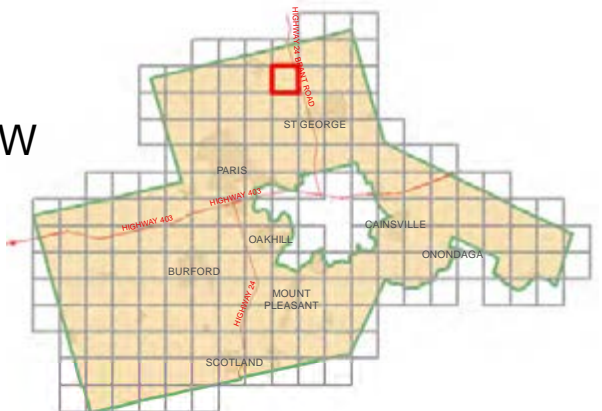

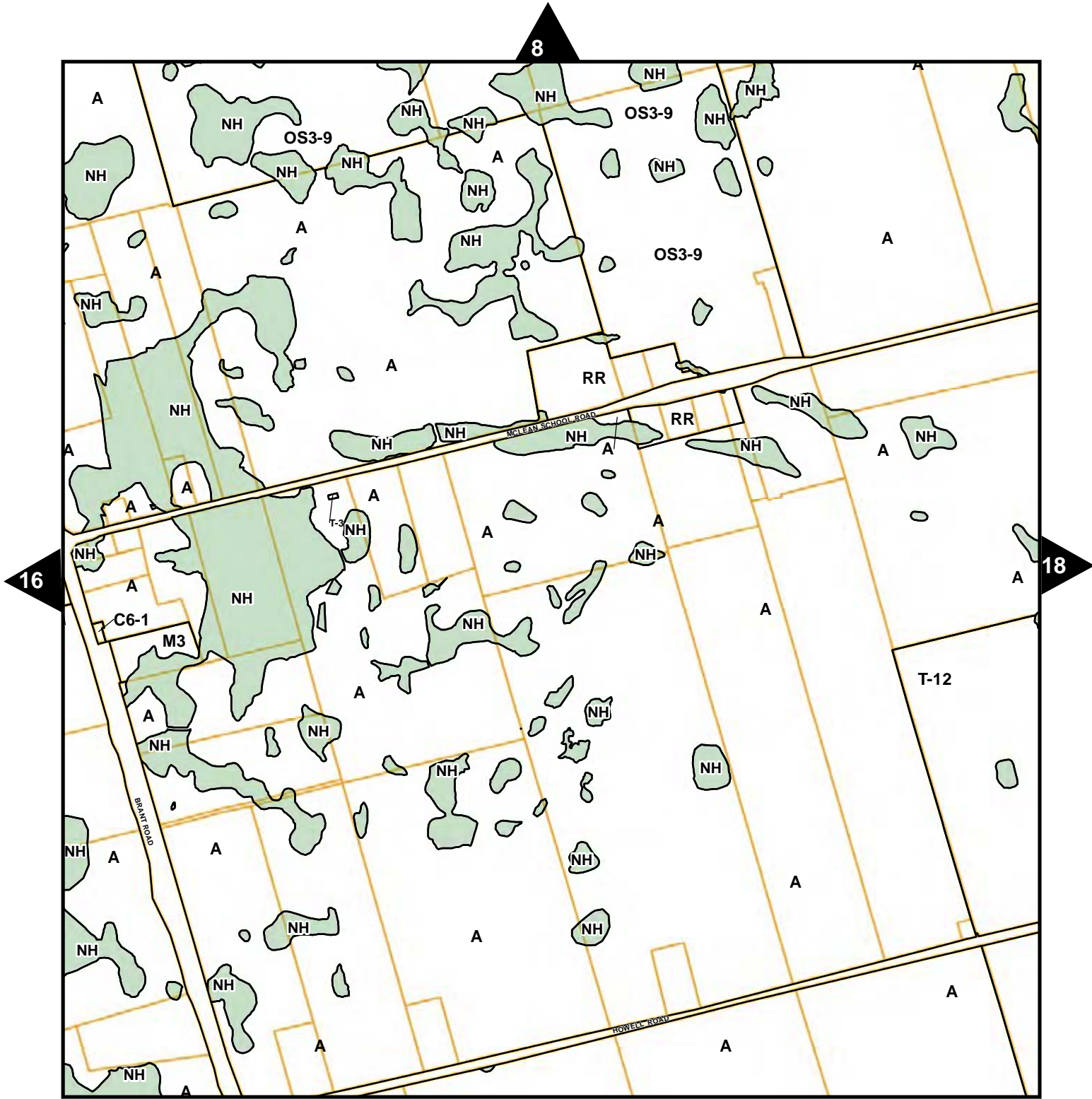

- Zoning
- Natural Heritage
- Parcel Fabric

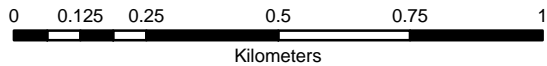

ZONING BY-LAW SCHEDULE 'A' Map No. 17





- Zoning
- Natural Heritage
- Parcel Fabric



ZONING BY-LAW
SCHEDULE 'A'
Map No. 18

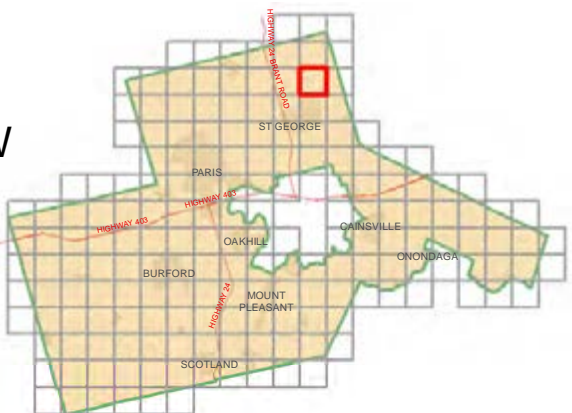

10

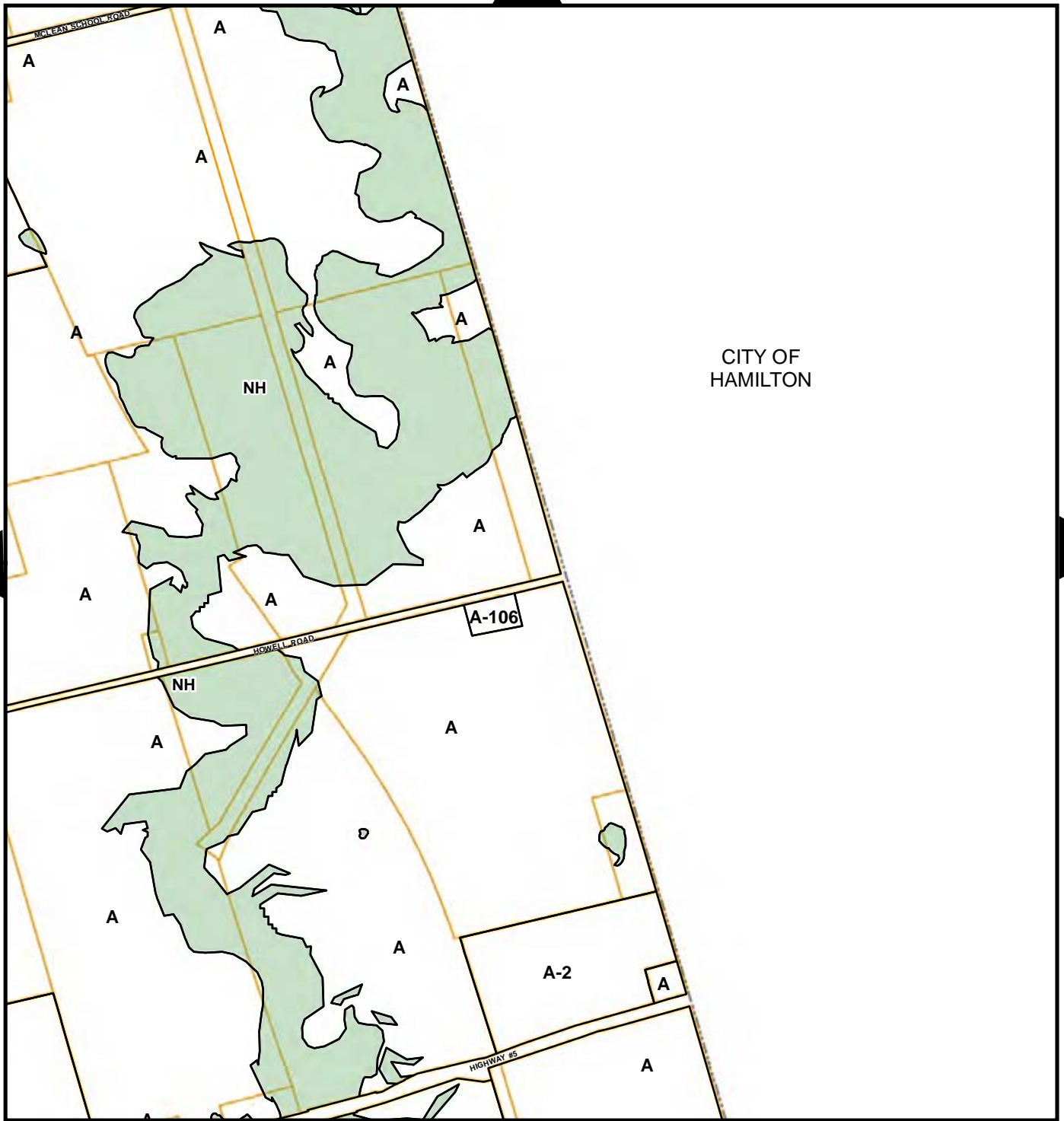



CITY OF HAMILTON

18

28



-  Zoning
-  Natural Heritage
-  Parcel Fabric

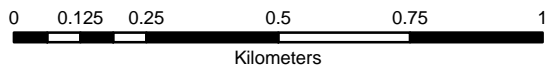

ZONING BY-LAW SCHEDULE 'A' Map No. 19



11

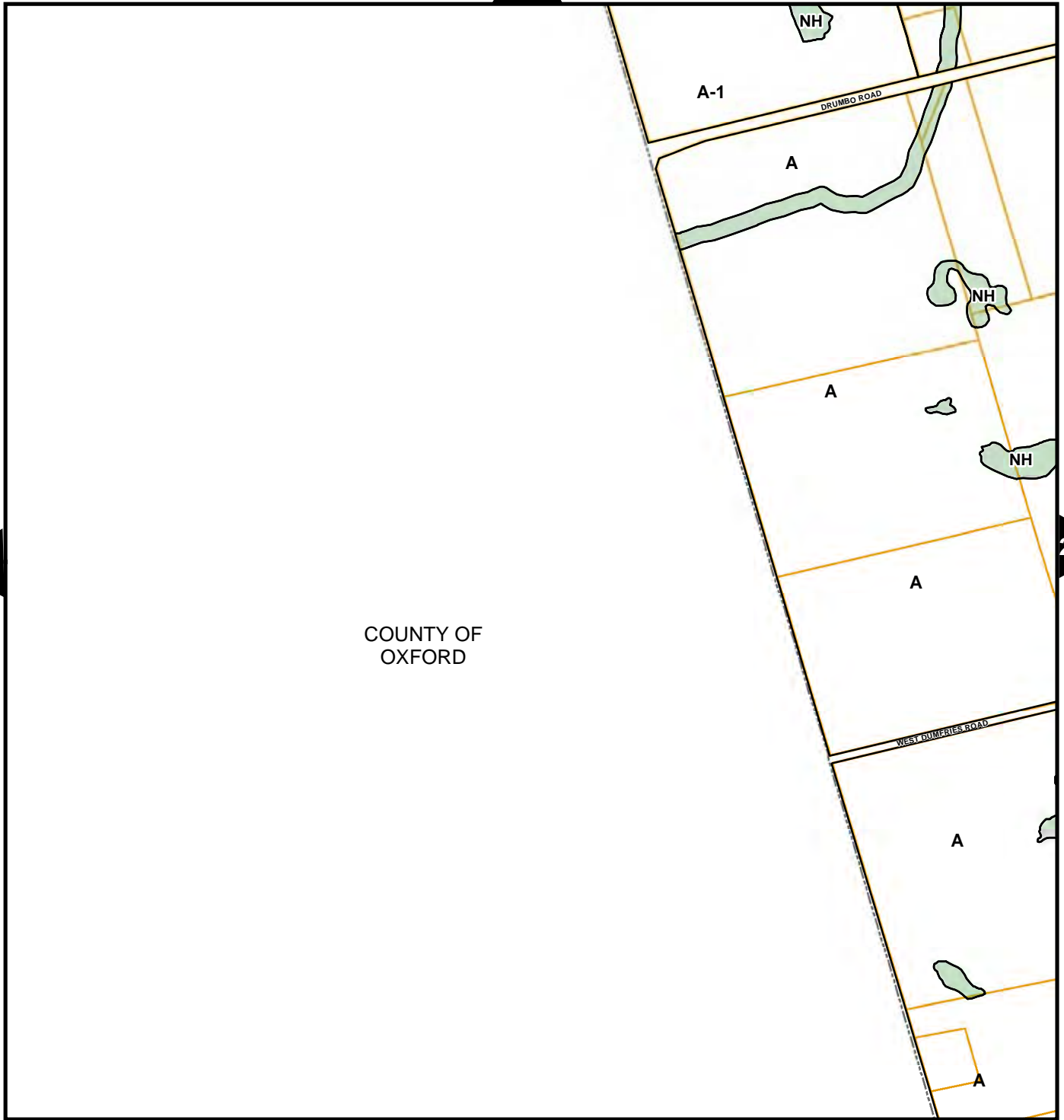



21

COUNTY OF OXFORD



29

ZONING BY-LAW
SCHEDULE 'A'
Map No. 20

-  Zoning
-  Natural Heritage
-  Parcel Fabric

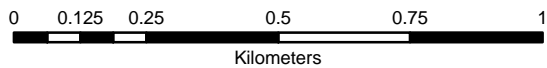

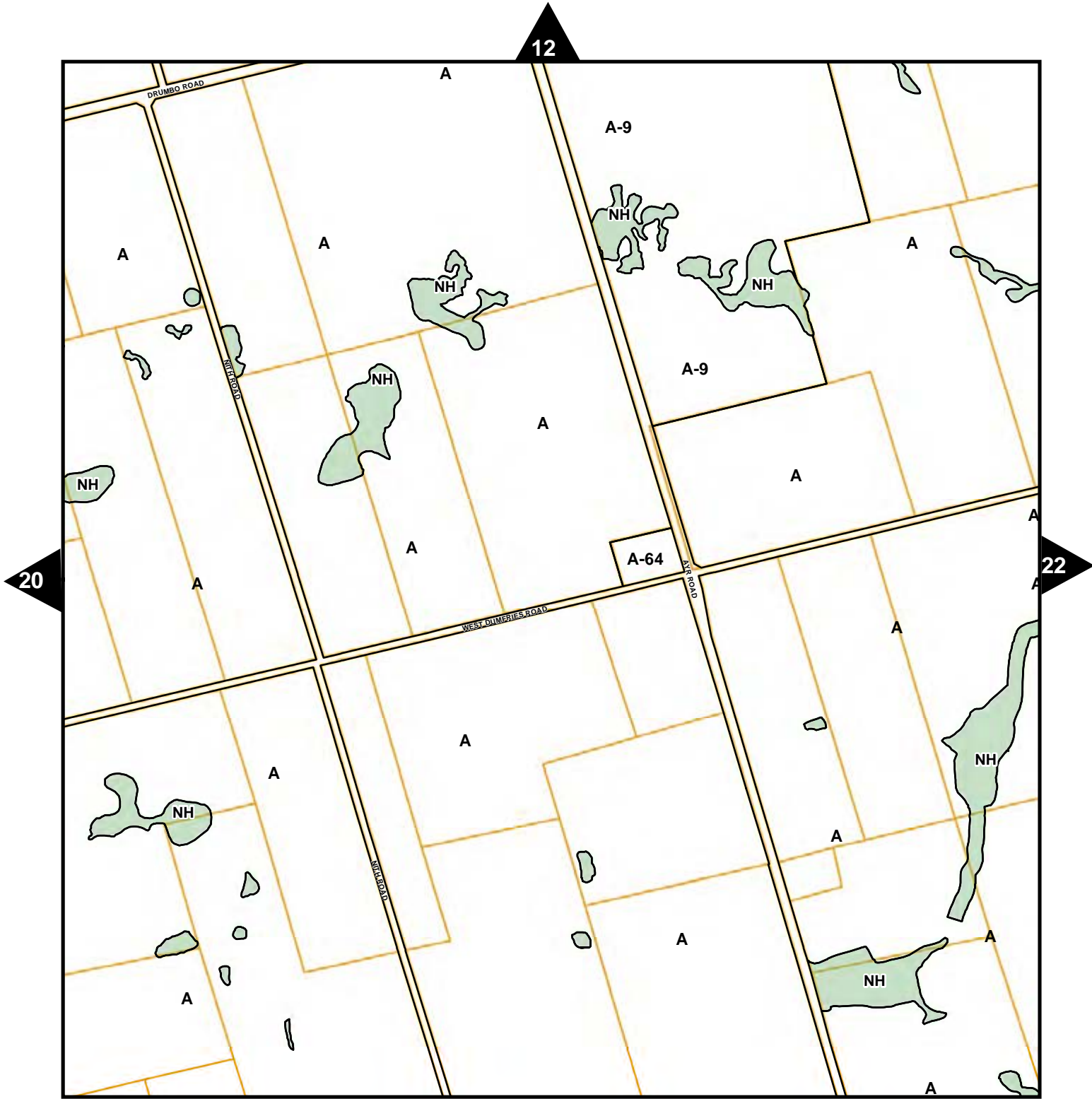





- Zoning
- Natural Heritage
- Parcel Fabric

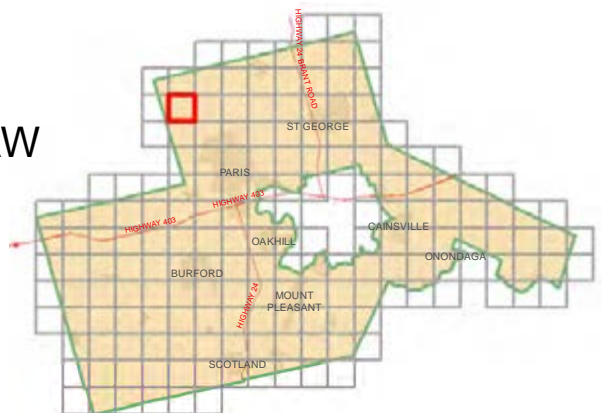

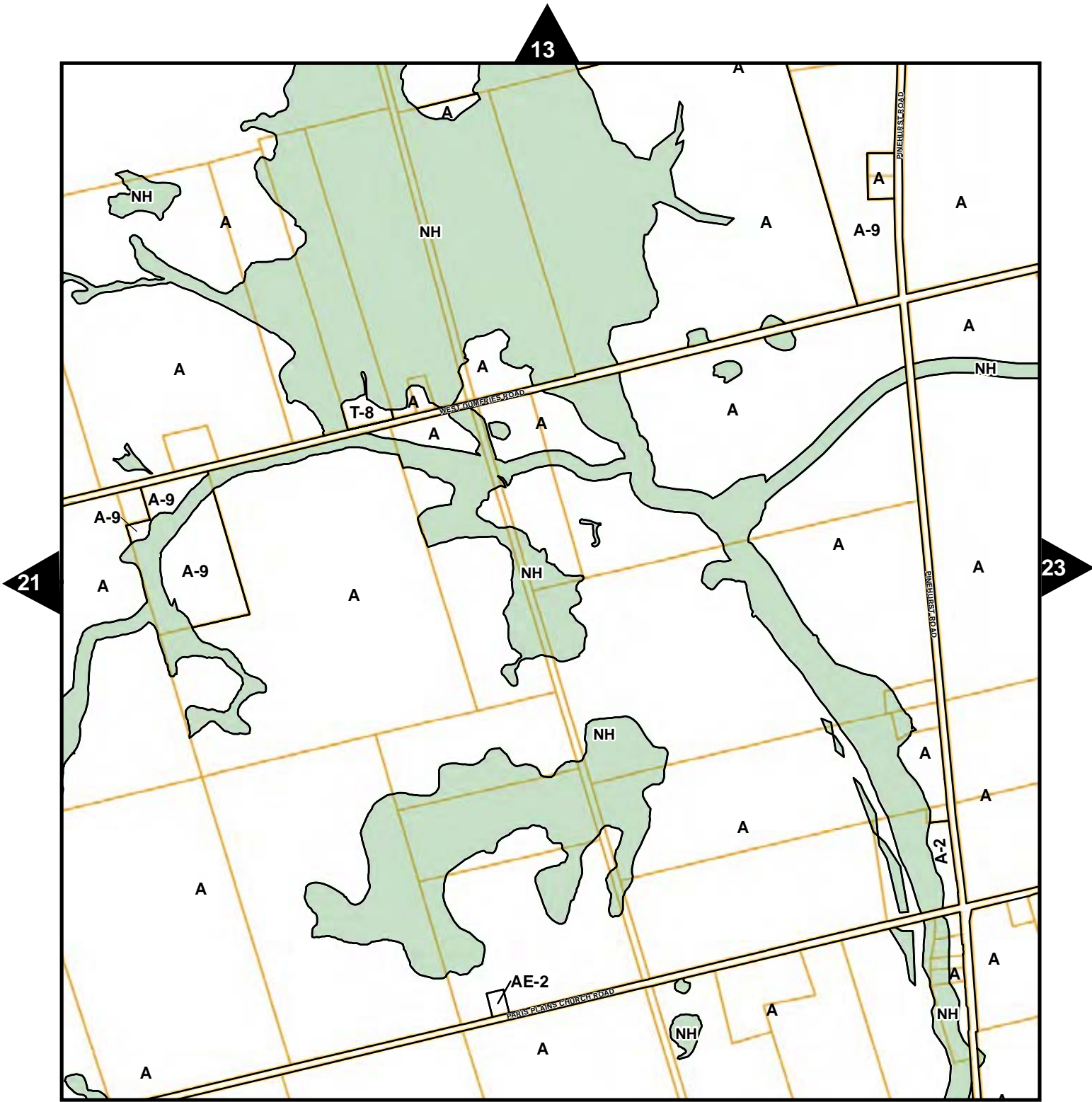
ZONING BY-LAW SCHEDULE 'A' Map No. 21





-  Zoning
-  Natural Heritage
-  Parcel Fabric



ZONING BY-LAW SCHEDULE 'A' Map No. 22

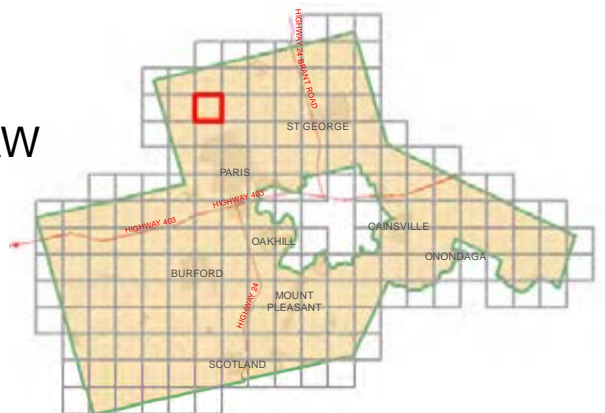

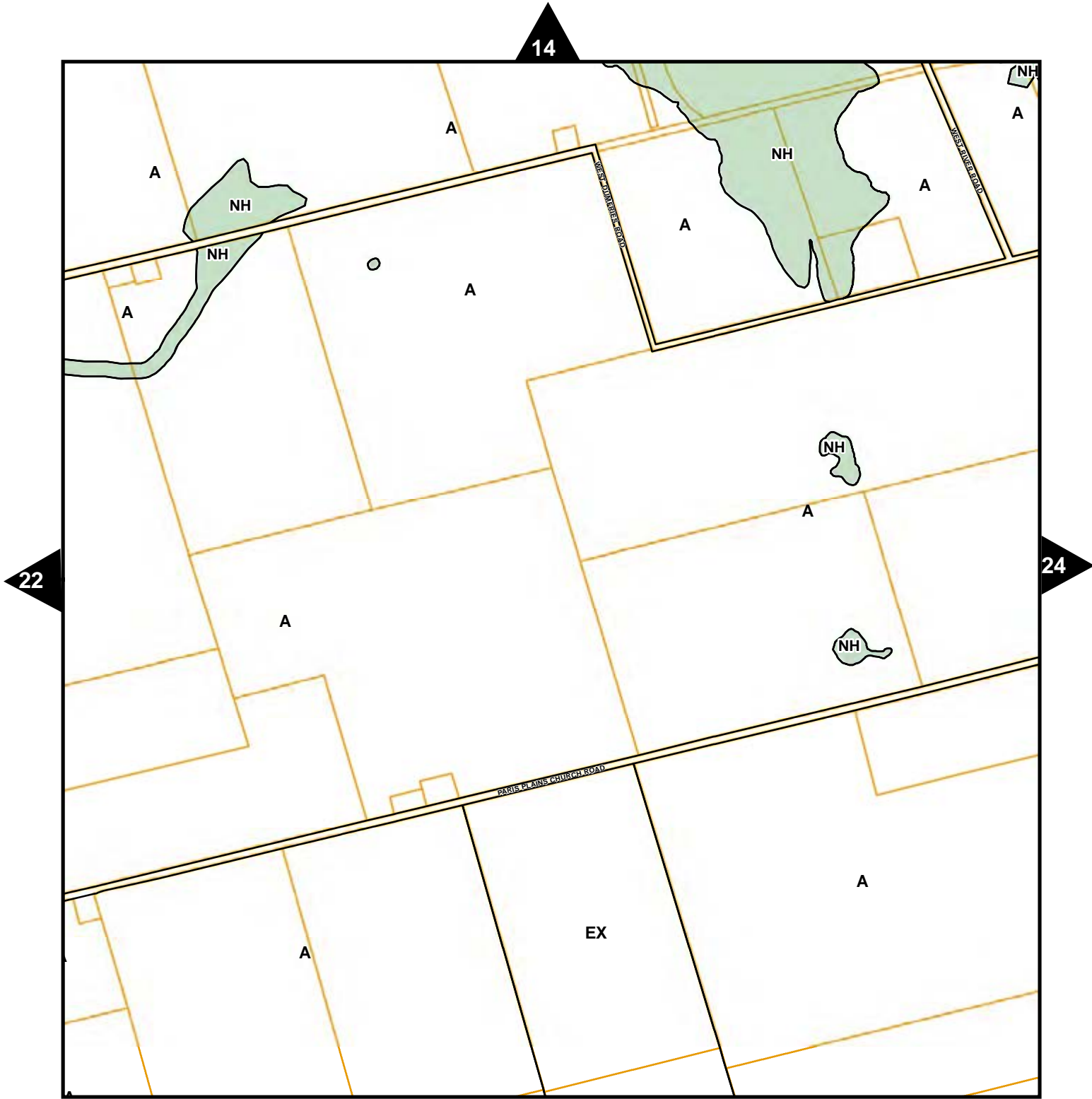

- Zoning
- Natural Heritage
- Parcel Fabric

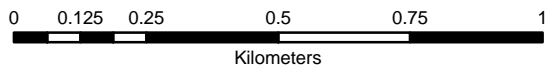

ZONING BY-LAW SCHEDULE 'A' Map No. 23

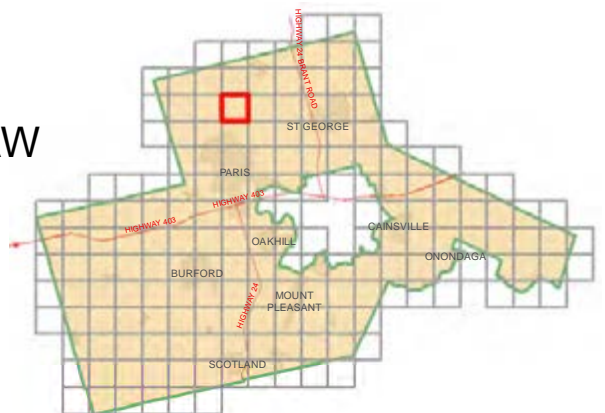

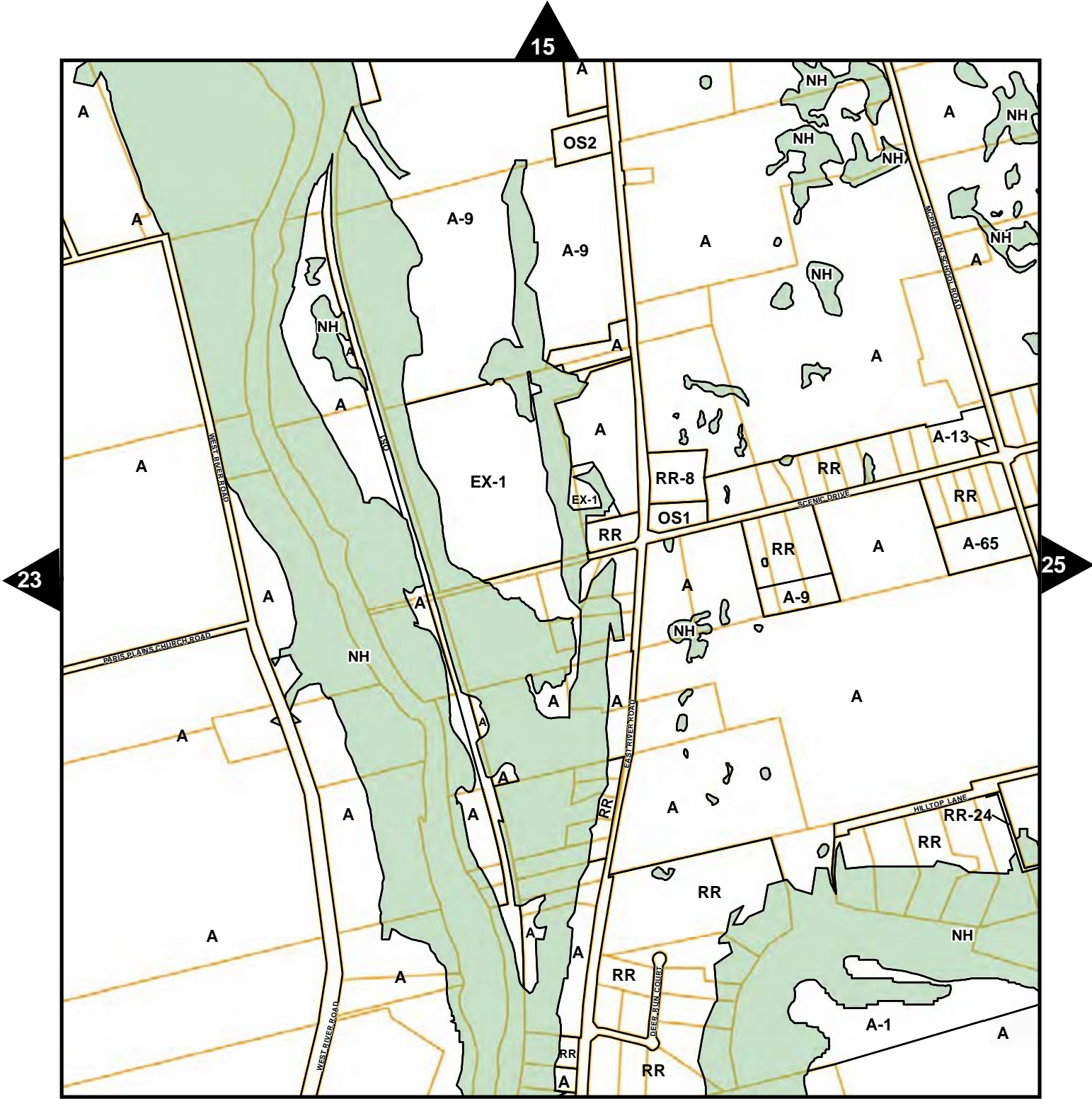

- Zoning
- Natural Heritage
- Parcel Fabric

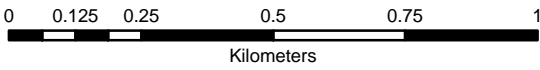

ZONING BY-LAW SCHEDULE 'A' Map No. 24



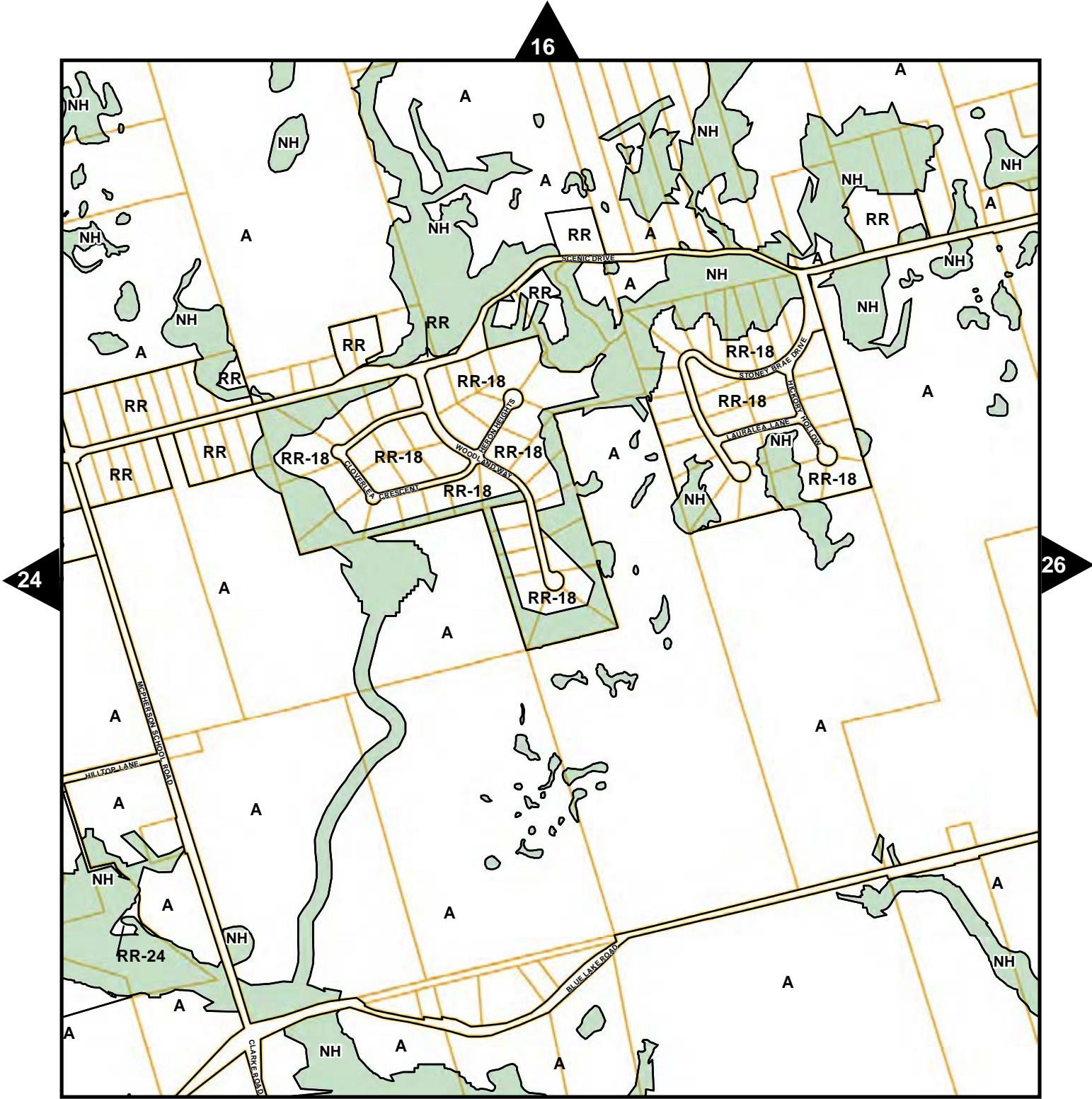

- Zoning
- Natural Heritage
- Parcel Fabric

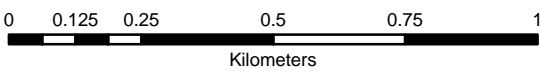

ZONING BY-LAW SCHEDULE 'A' Map No. 25



17

25

27

35

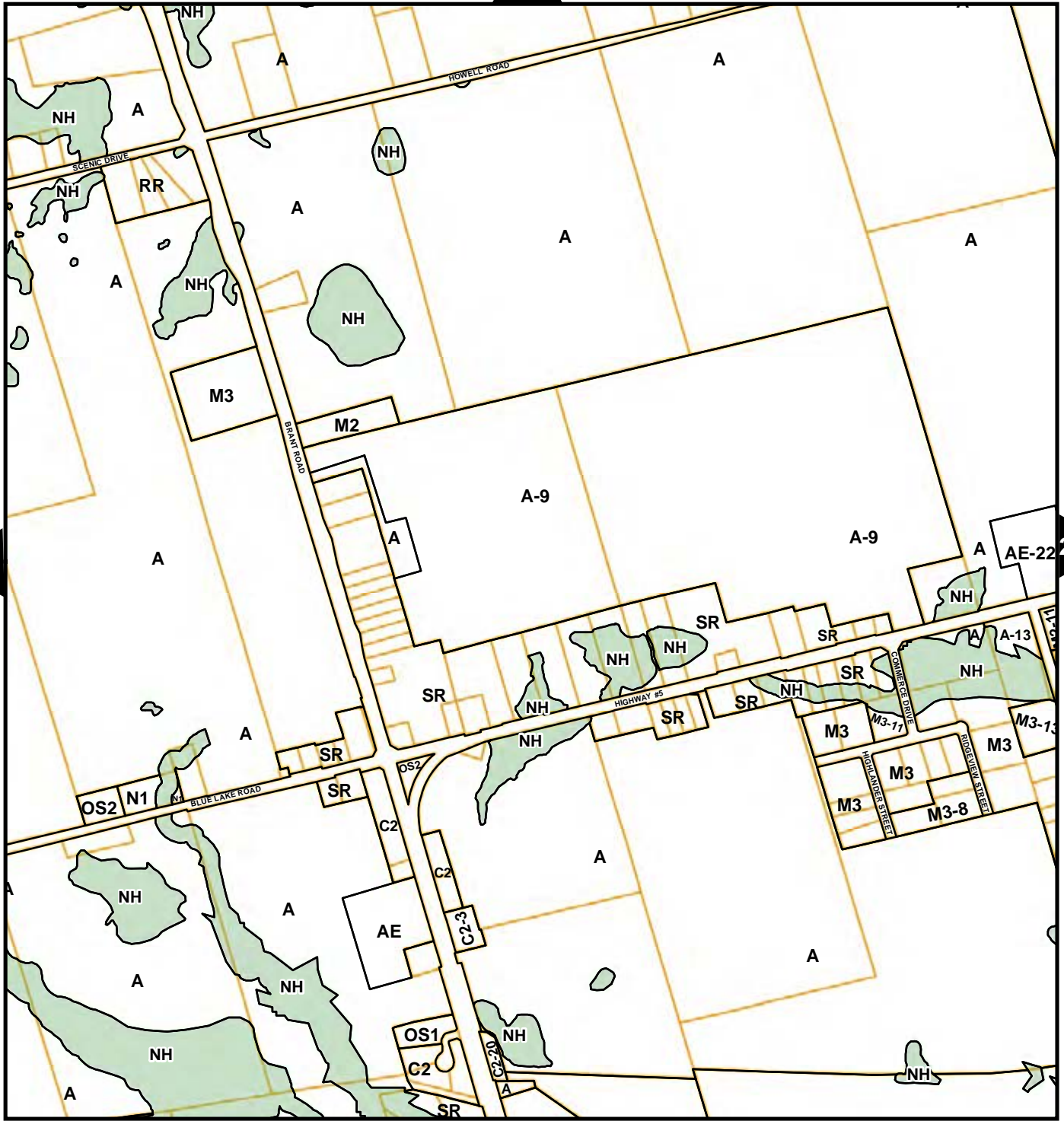

- Zoning
- Natural Heritage
- Parcel Fabric

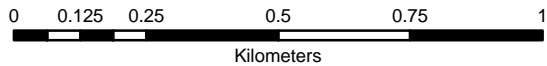

ZONING BY-LAW
SCHEDULE 'A'
Map No. 26



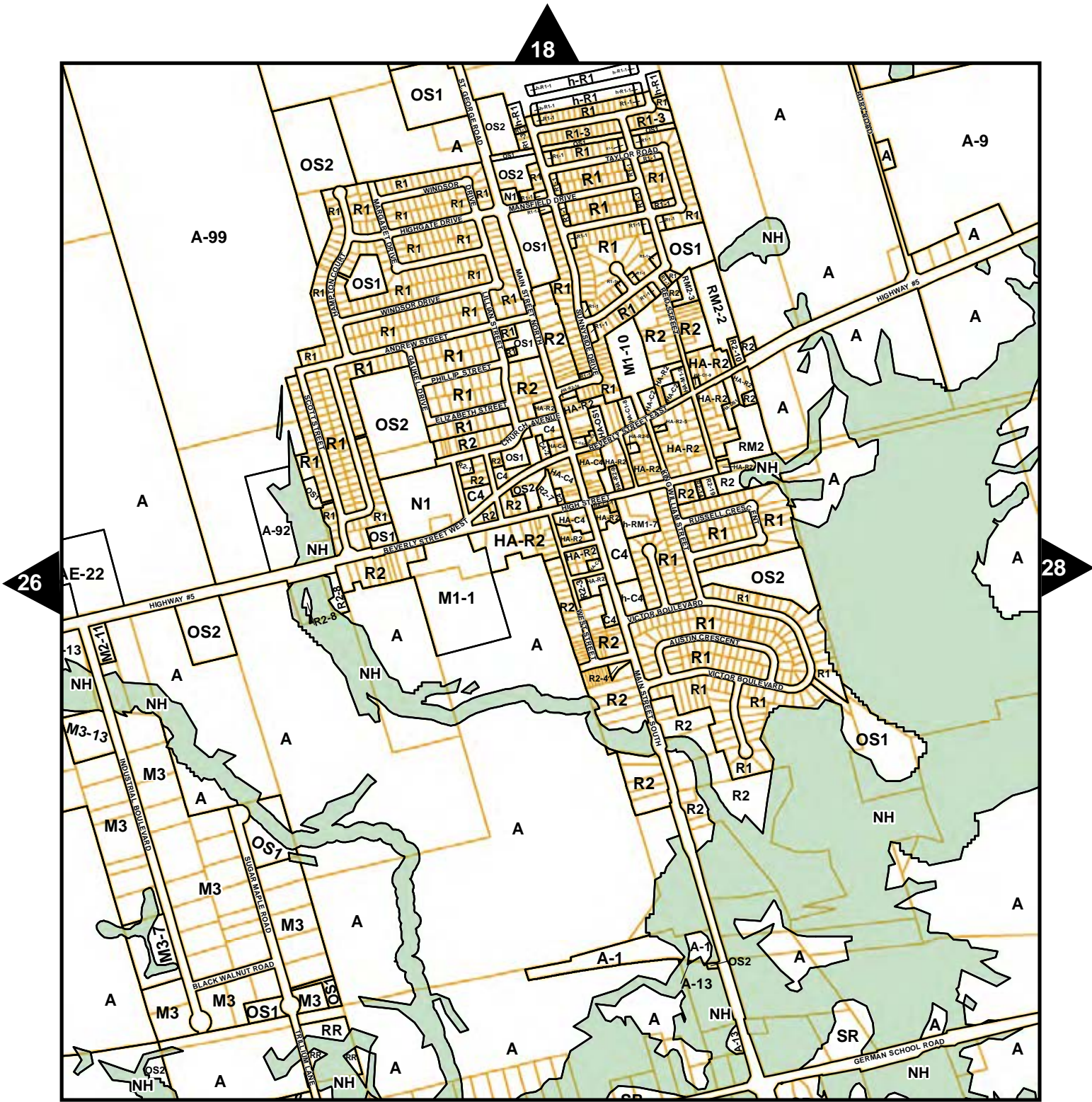

- Zoning
- Natural Heritage
- Parcel Fabric

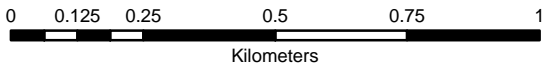

ZONING BY-LAW SCHEDULE 'A' Map No. 27



18

26

28

36

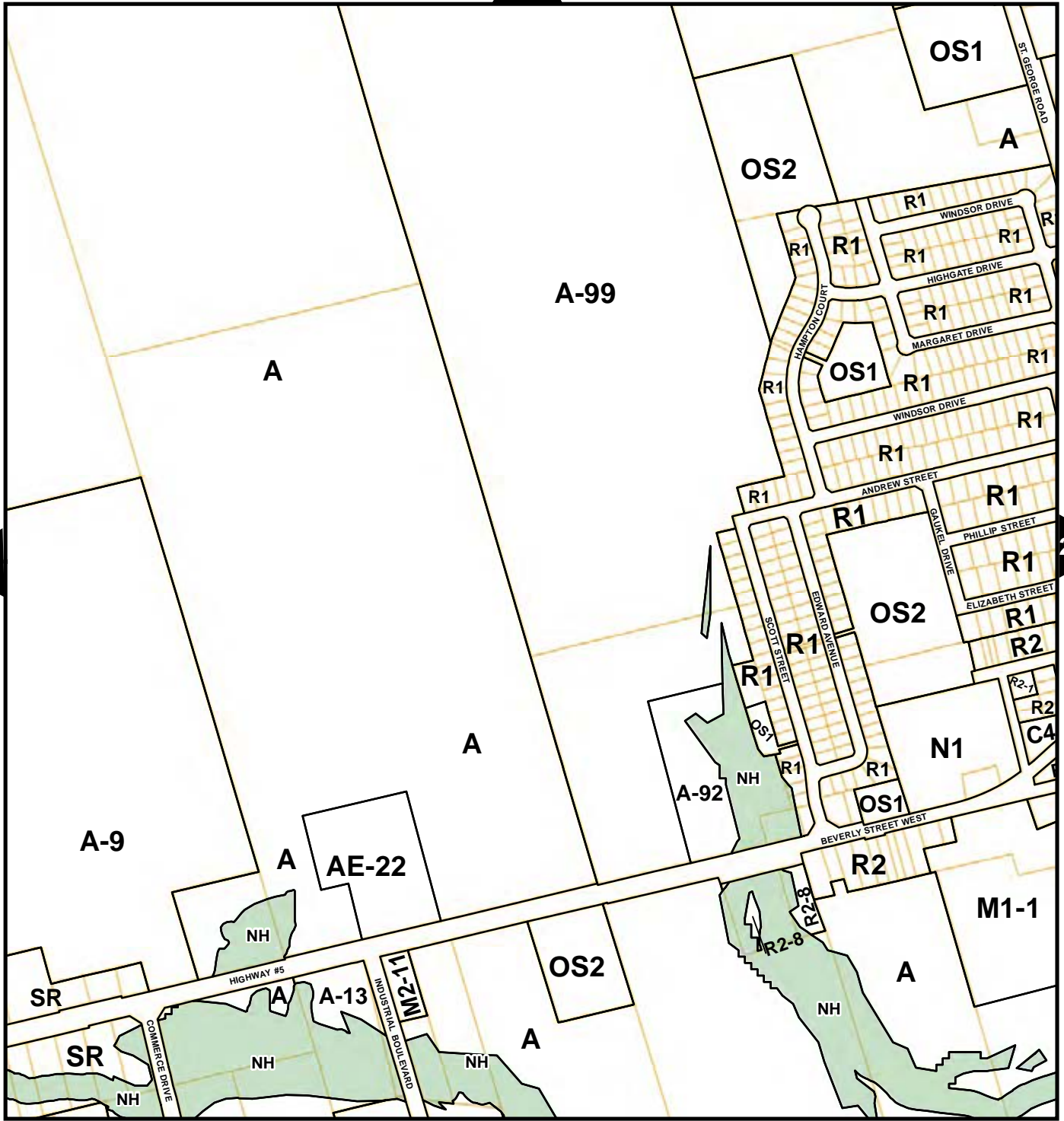

ZONING BY-LAW
SCHEDULE 'A'
Map No.27A

- Zoning
- Natural Hazard
- Parcel Fabric

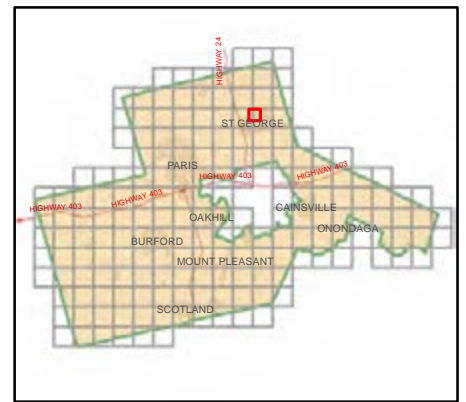
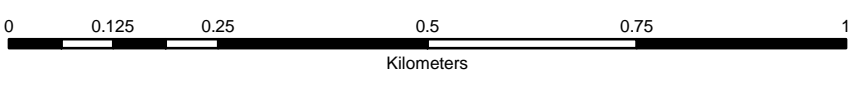



- Zoning
- Natural Hazard
- Parcel Fabric

ZONING BY-LAW
SCHEDULE 'A'
Map No.27C

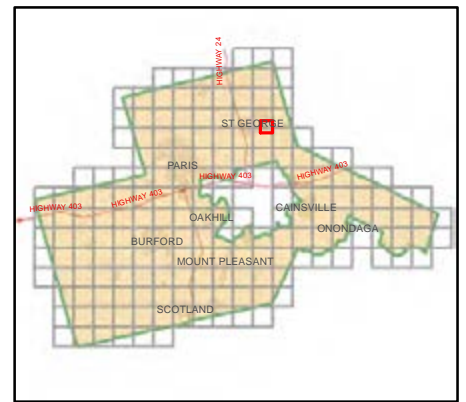
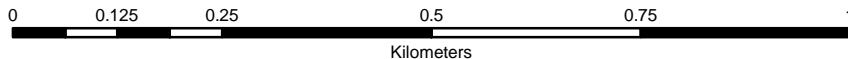

18

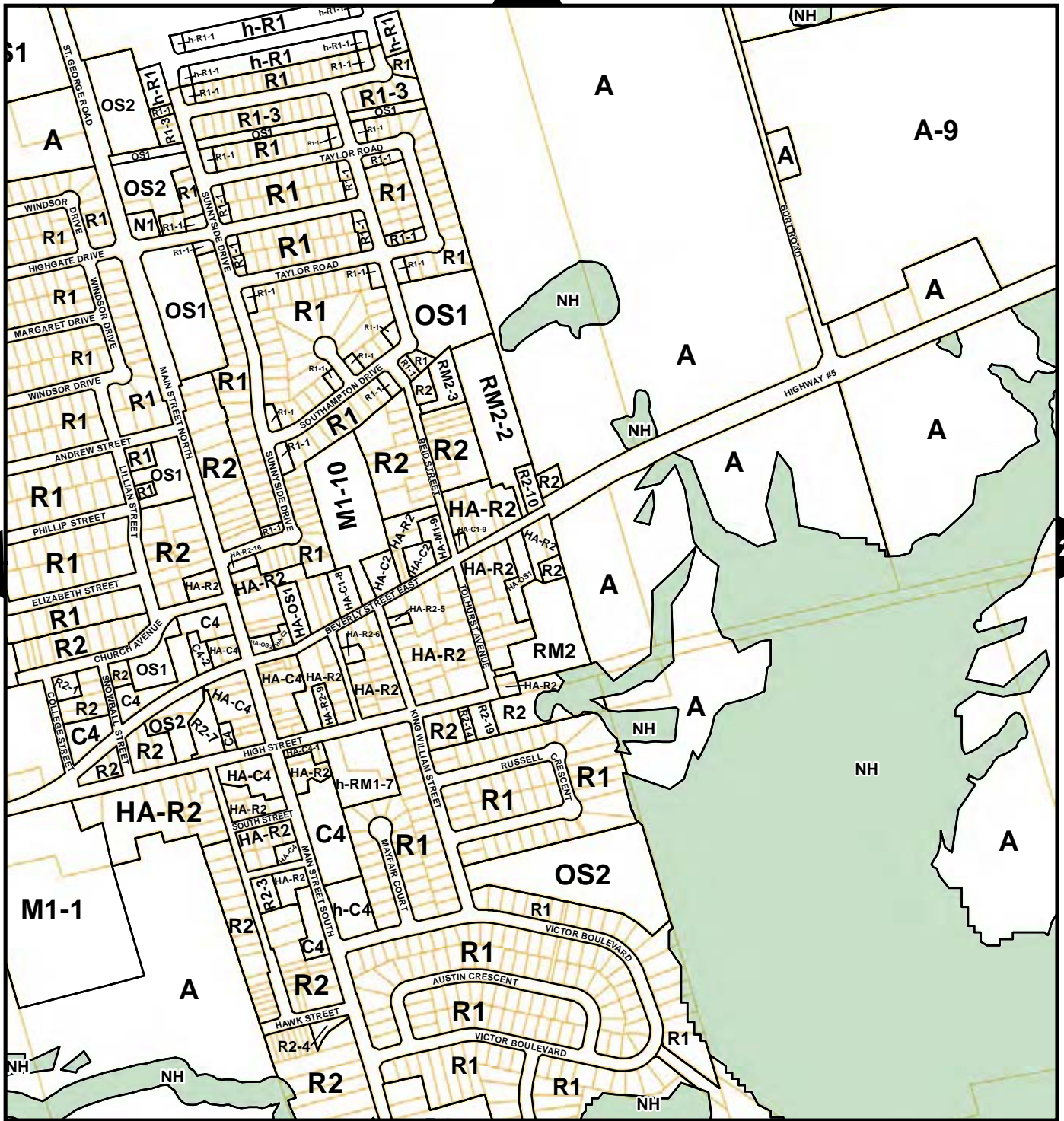

26

28

36



ZONING BY-LAW
SCHEDULE 'A'
Map No.27B

- Zoning
- Natural Hazard
- Parcel Fabric

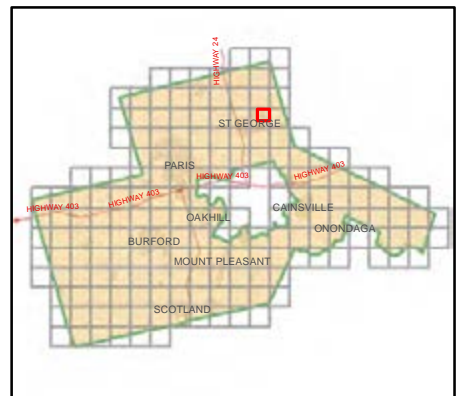
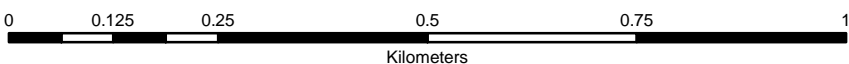

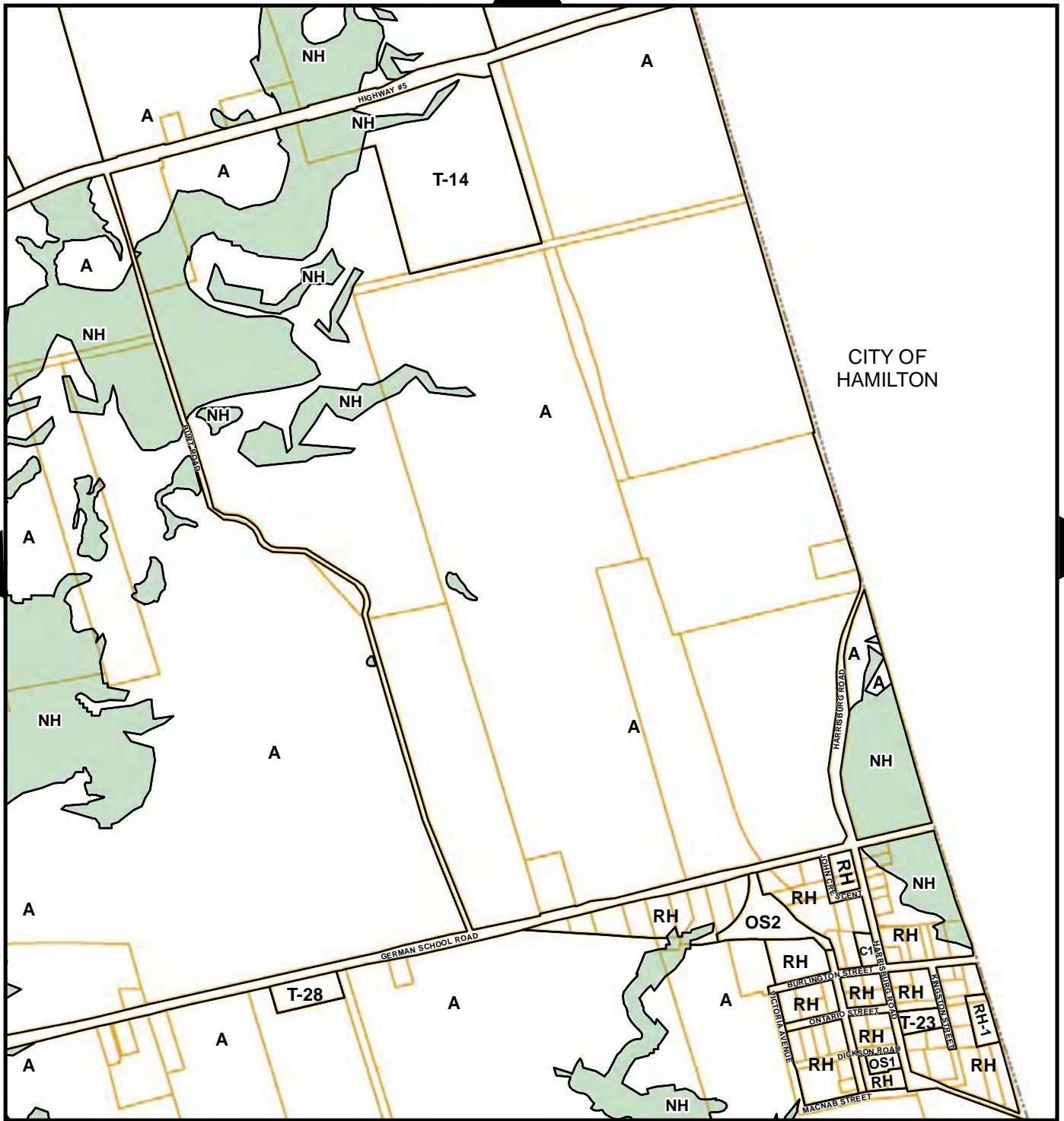

19



37



ZONING BY-LAW
SCHEDULE 'A'
Map No. 28

-  Zoning
-  Natural Heritage
-  Parcel Fabric

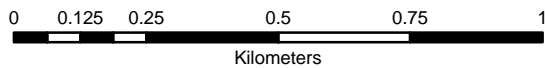



20

30

COUNTY OF OXFORD





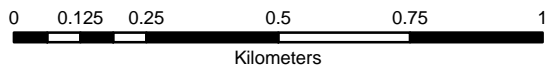

-  Zoning
-  Natural Heritage
-  Parcel Fabric

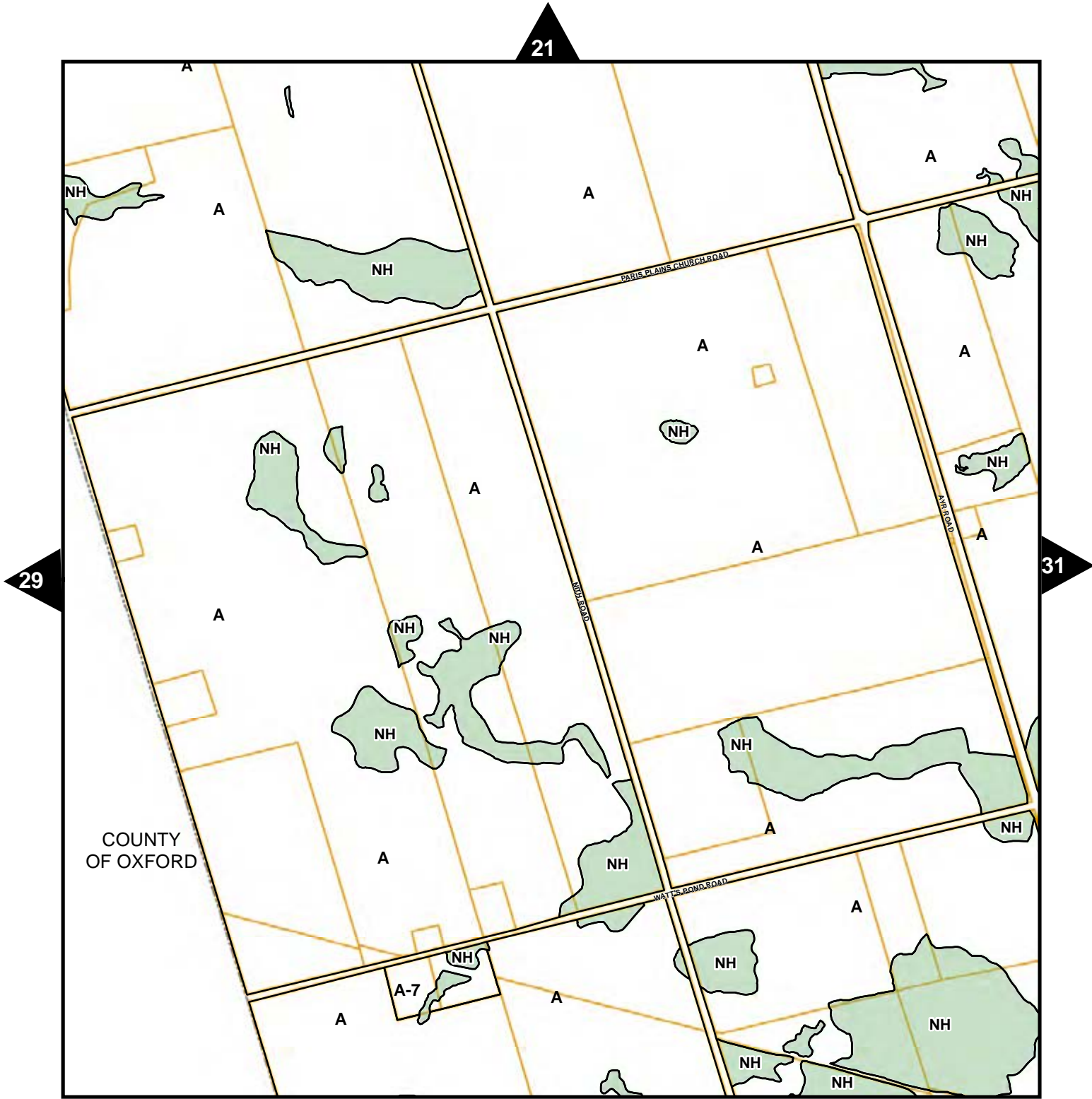

ZONING BY-LAW
SCHEDULE 'A'
Map No. 29





-  Zoning
-  Natural Heritage
-  Parcel Fabric

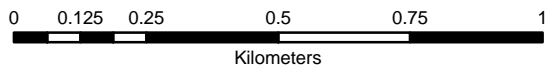

ZONING BY-LAW SCHEDULE 'A' Map No. 30



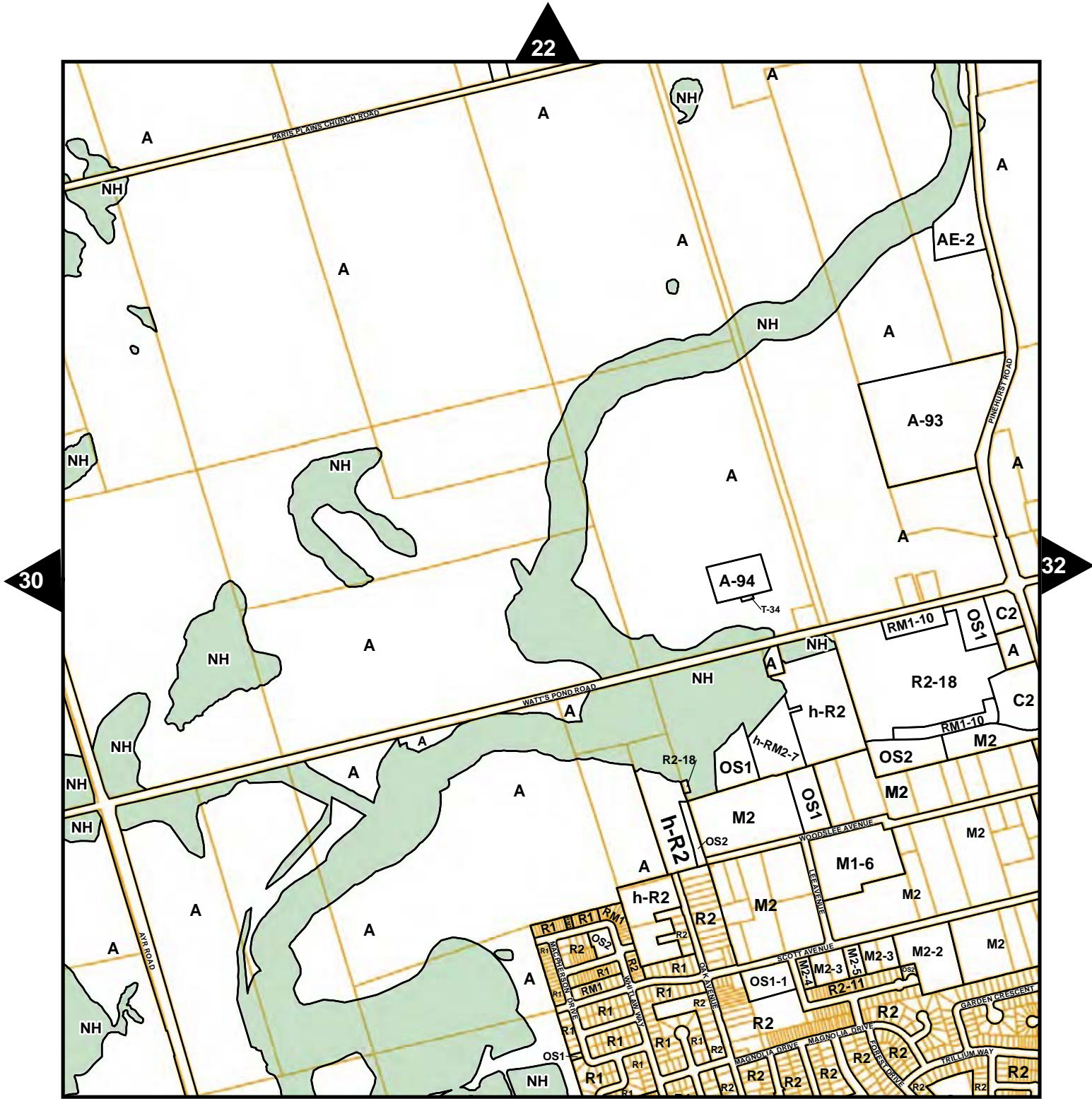

- Zoning
- Natural Heritage
- Parcel Fabric



ZONING BY-LAW
SCHEDULE 'A'
Map No. 31



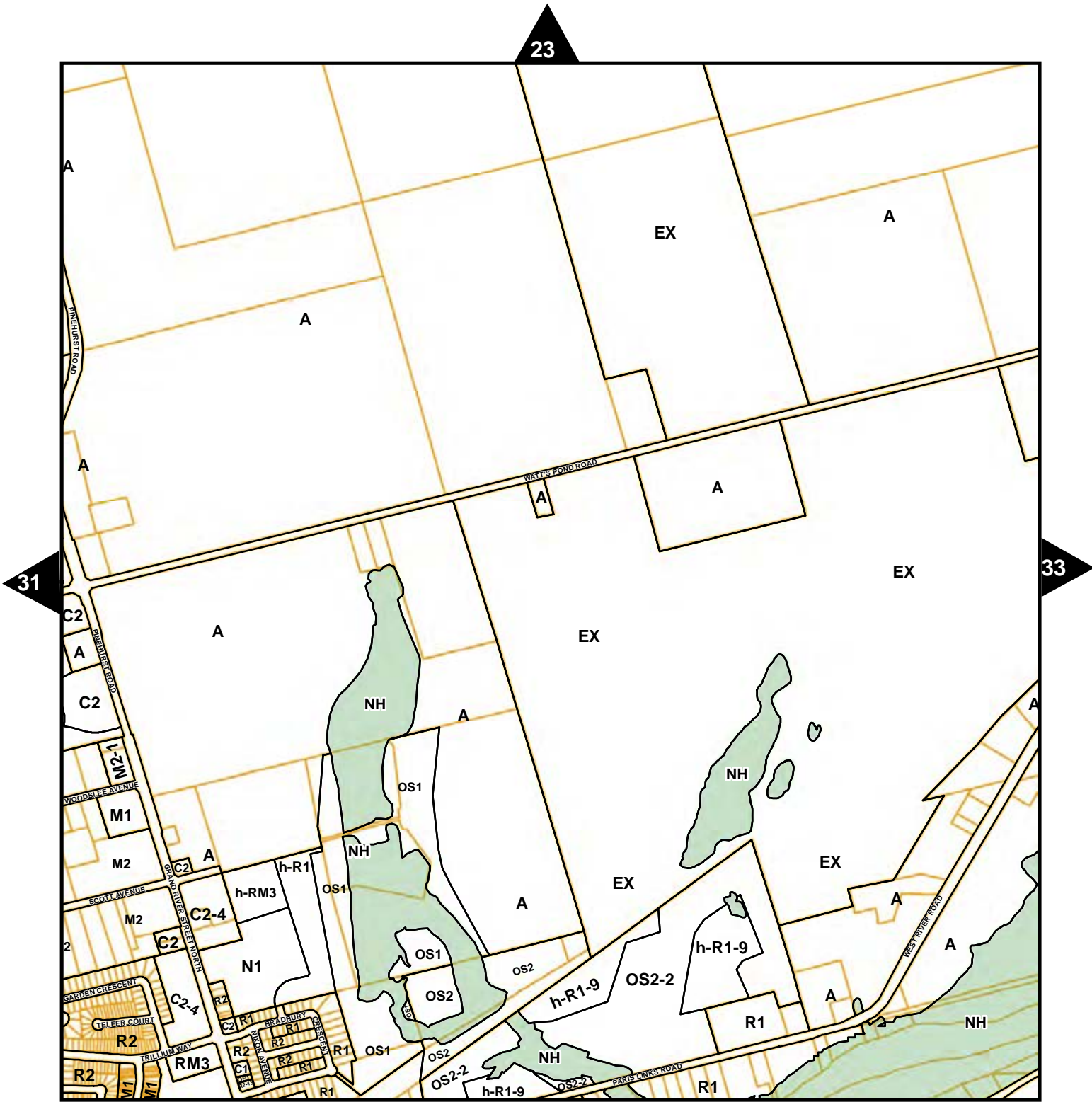

- Zoning
- Natural Heritage
- Parcel Fabric

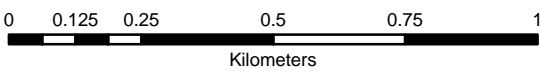

ZONING BY-LAW
SCHEDULE 'A'
Map No. 32



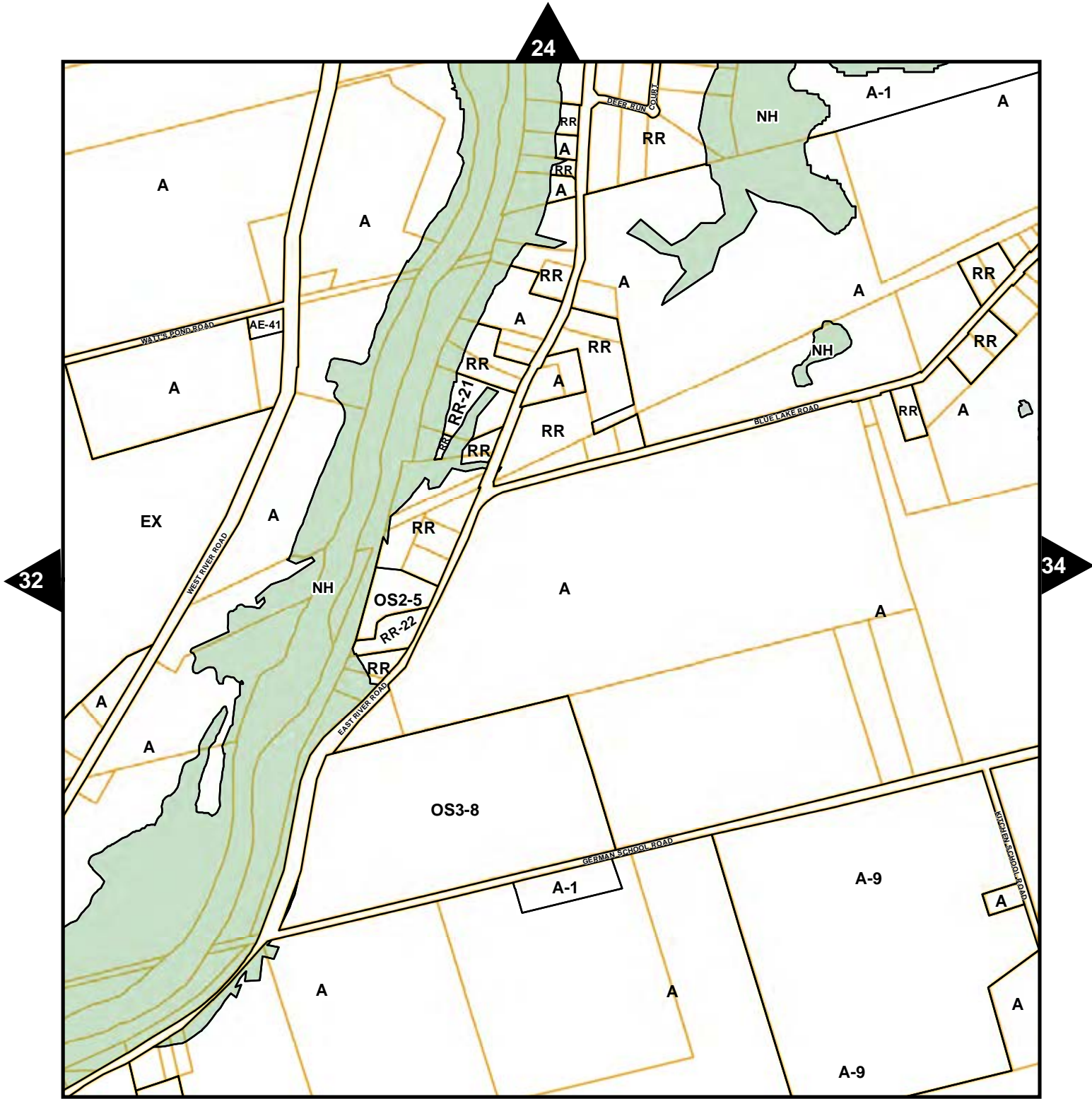



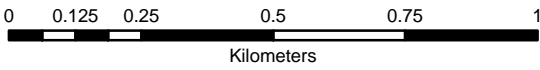

- Zoning
- Natural Heritage
- Parcel Fabric

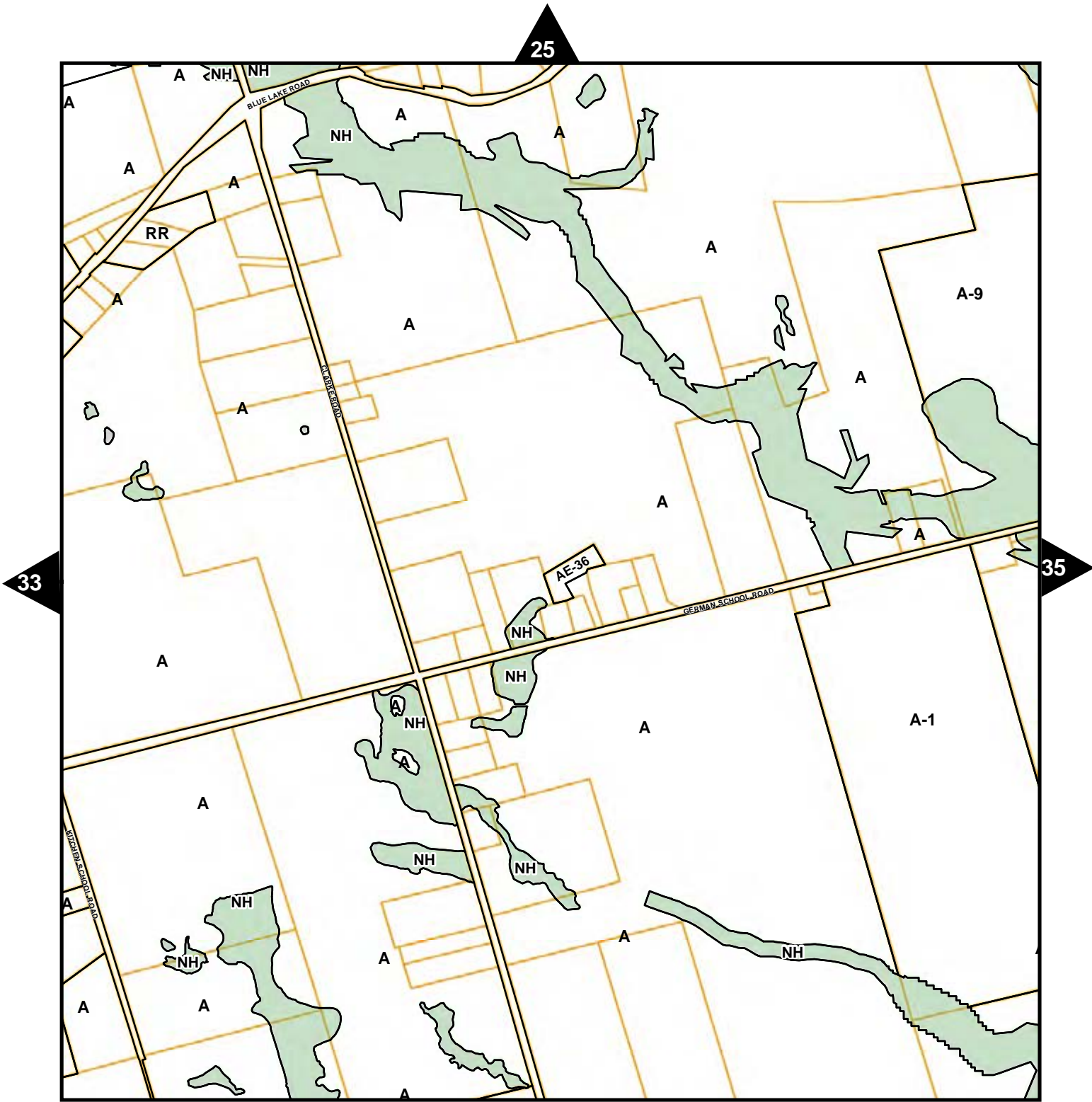

ZONING BY-LAW
SCHEDULE 'A'
Map No. 33





-  Zoning
-  Natural Heritage
-  Parcel Fabric

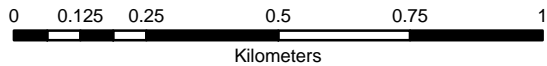

ZONING BY-LAW SCHEDULE 'A' Map No. 34



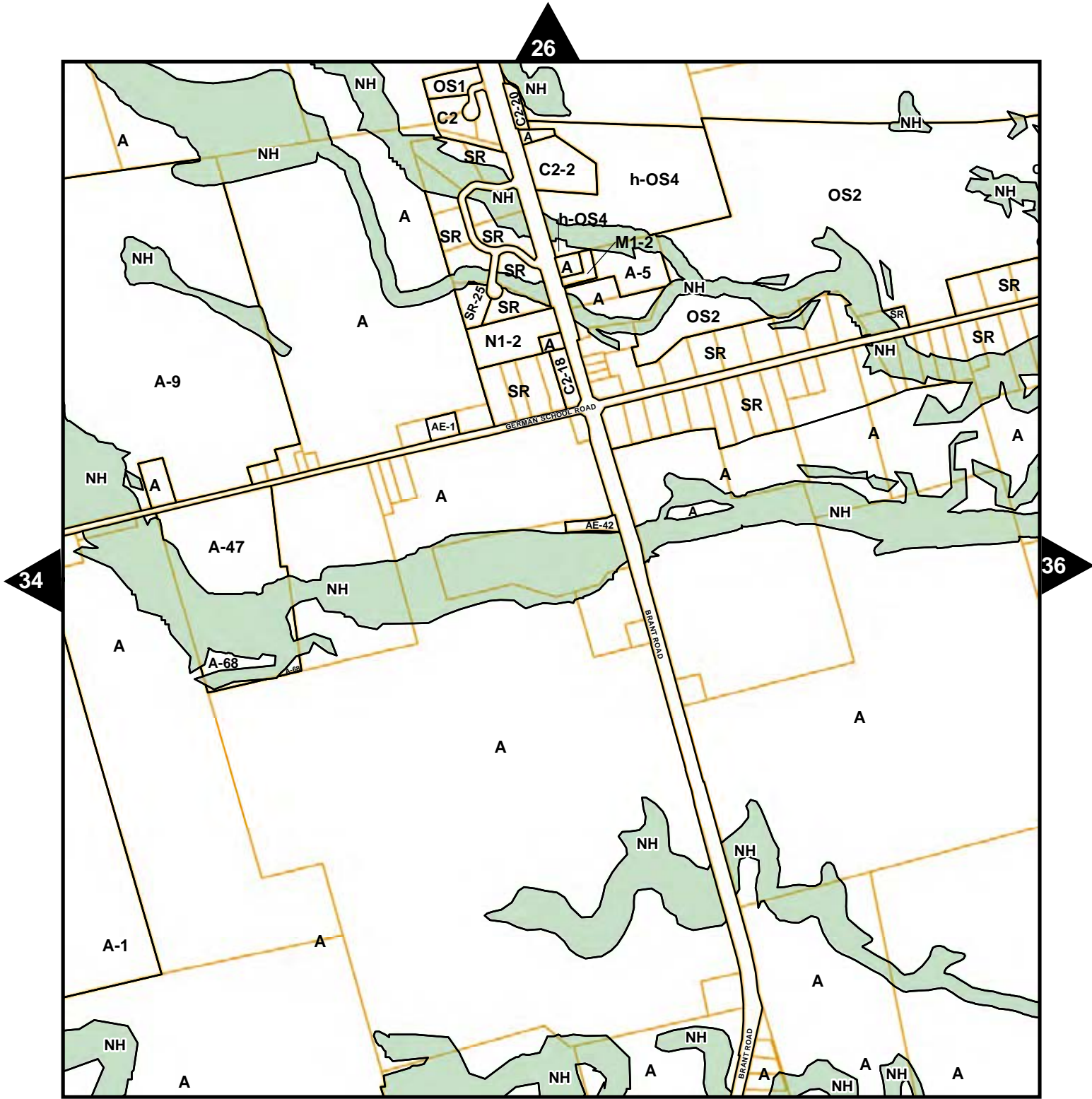

- Zoning
- Natural Heritage
- Parcel Fabric



ZONING BY-LAW SCHEDULE 'A' Map No. 35



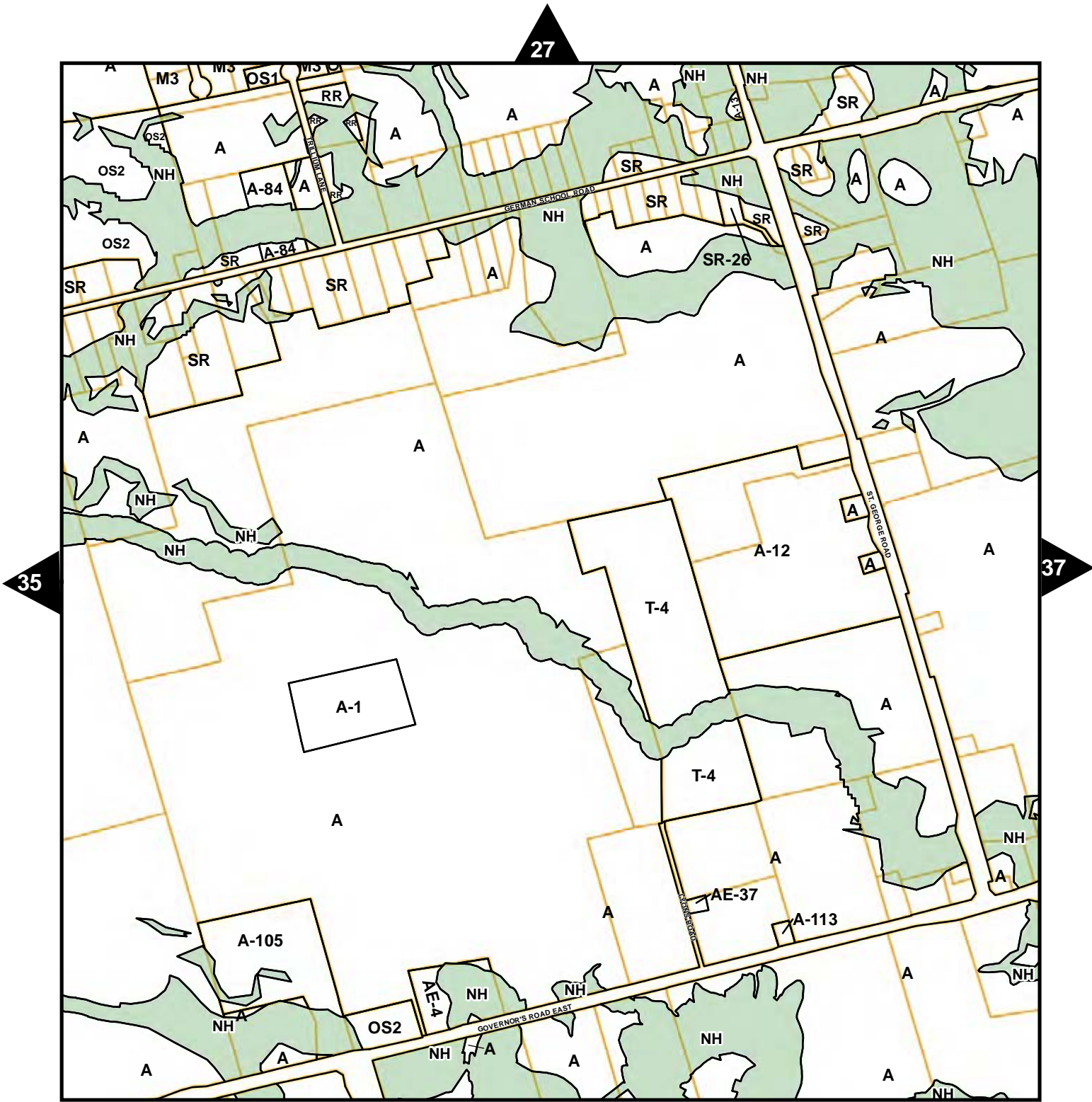



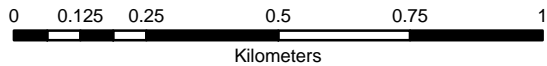

- Zoning
- Natural Heritage
- Parcel Fabric

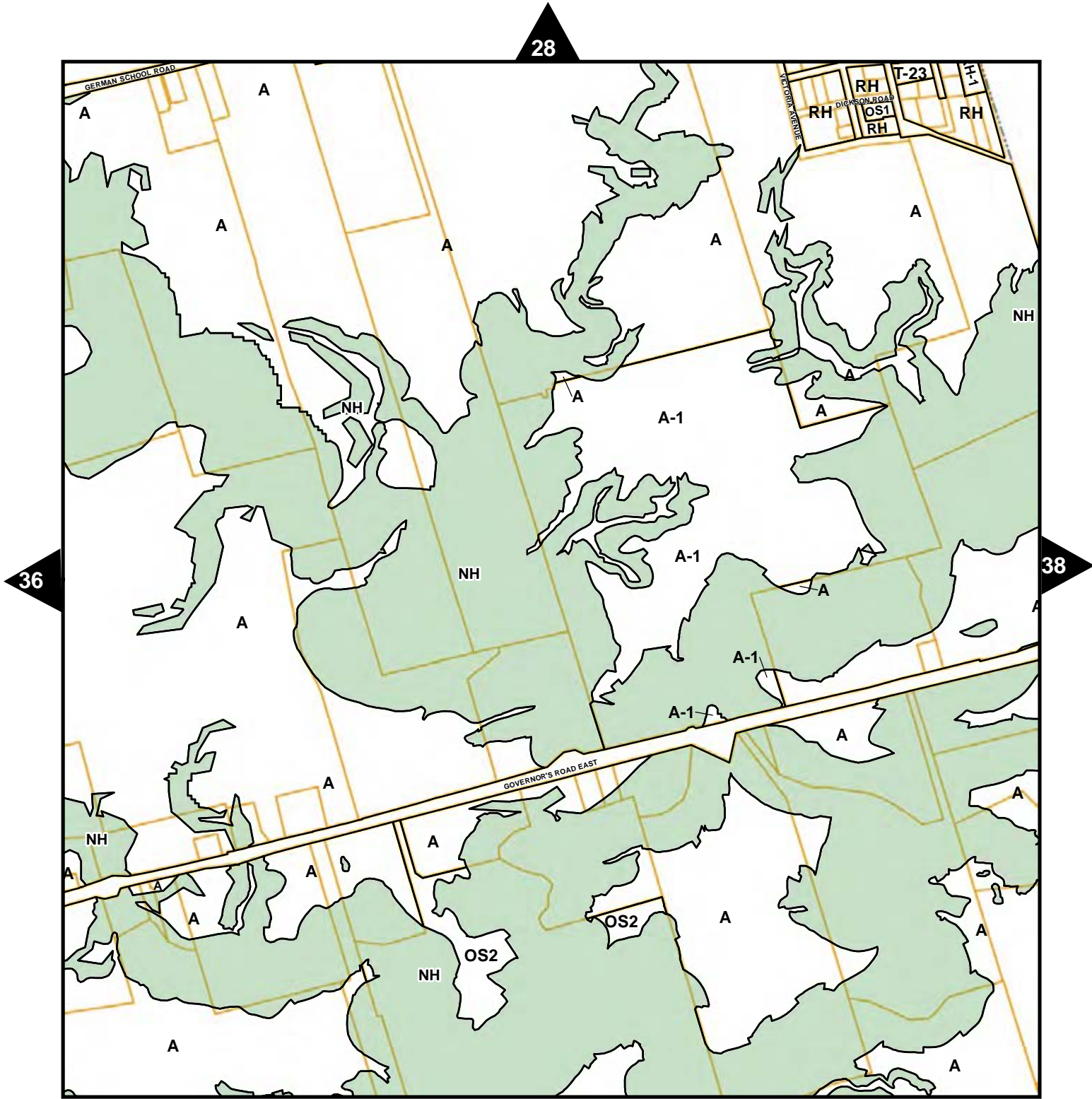

ZONING BY-LAW SCHEDULE 'A' Map No. 36





-  Zoning
-  Natural Heritage
-  Parcel Fabric



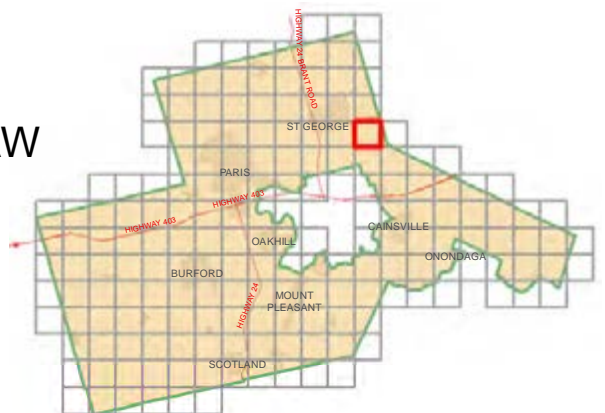

ZONING BY-LAW SCHEDULE 'A' Map No. 37

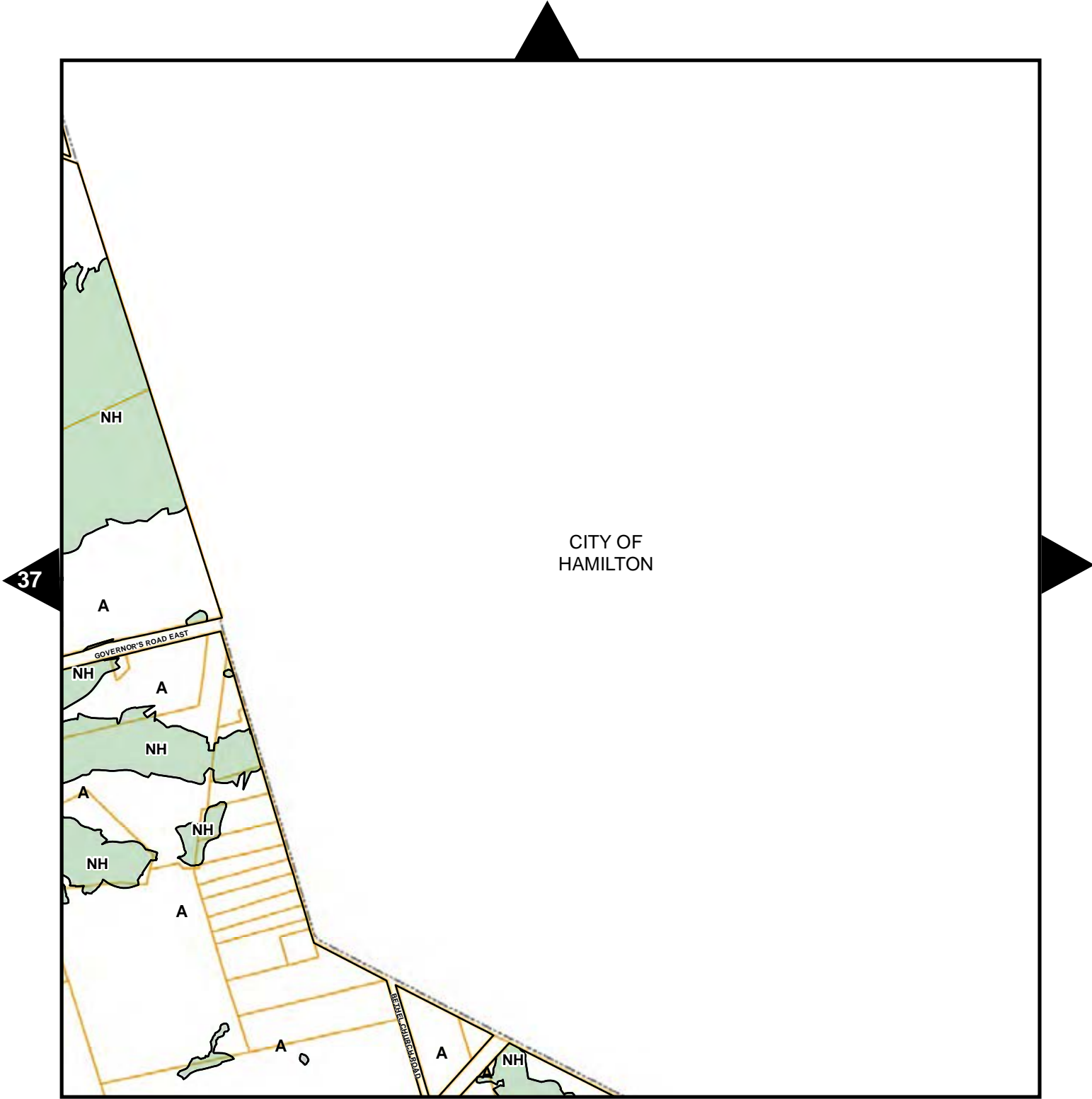



CITY OF HAMILTON



-  Zoning
-  Natural Heritage
-  Parcel Fabric

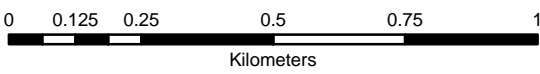

ZONING BY-LAW
SCHEDULE 'A'
Map No. 38



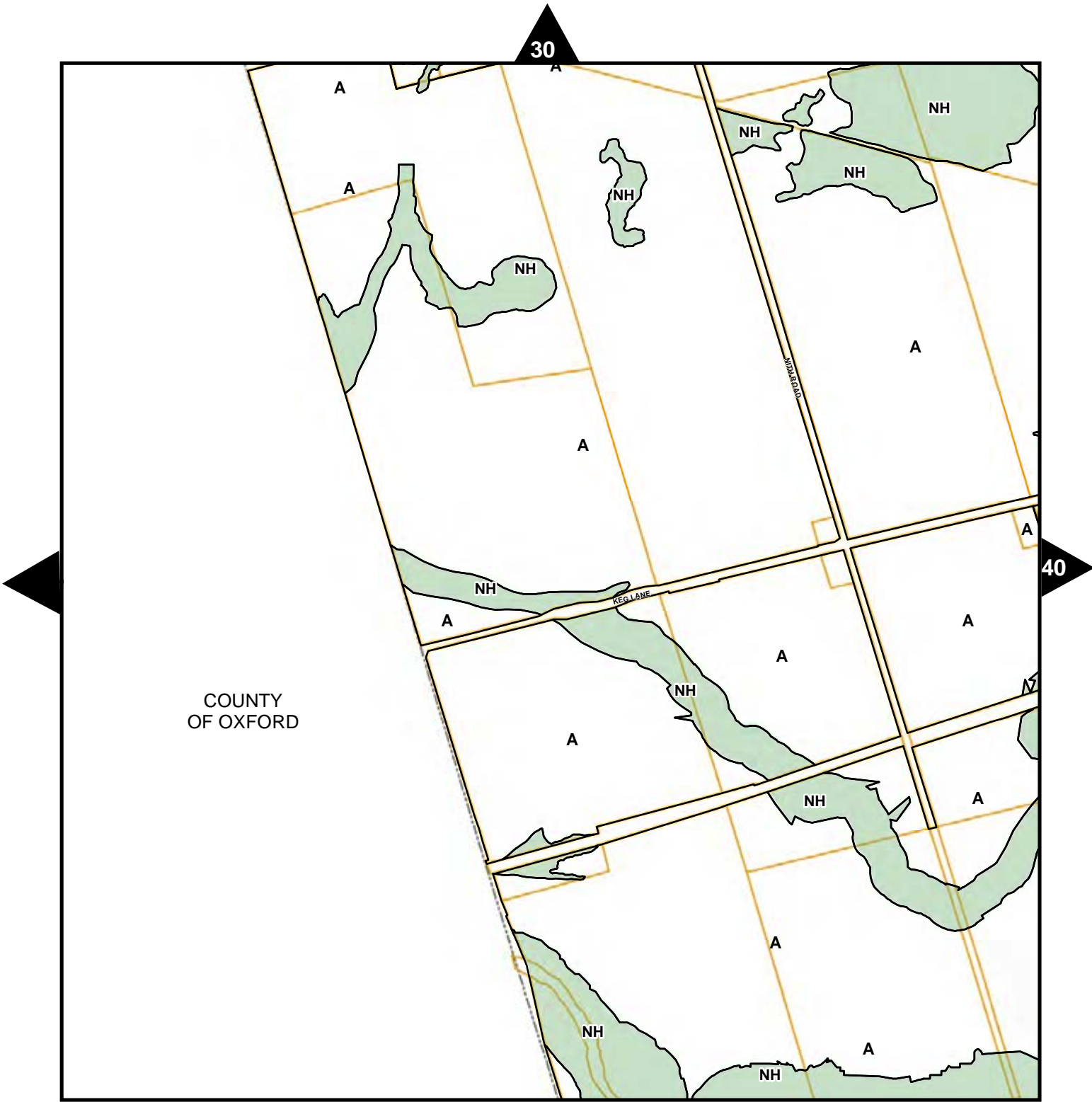

- Zoning
- Natural Heritage
- Parcel Fabric



ZONING BY-LAW
SCHEDULE 'A'
Map No. 39

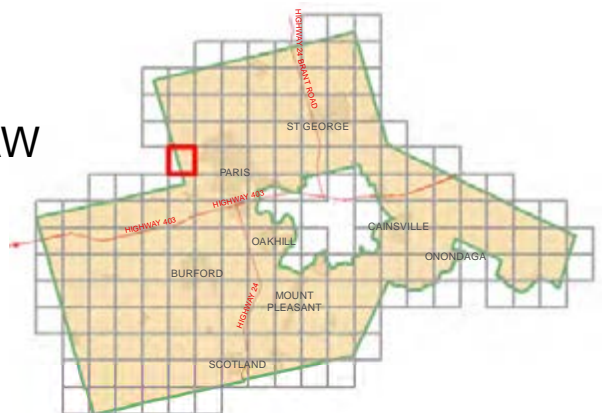

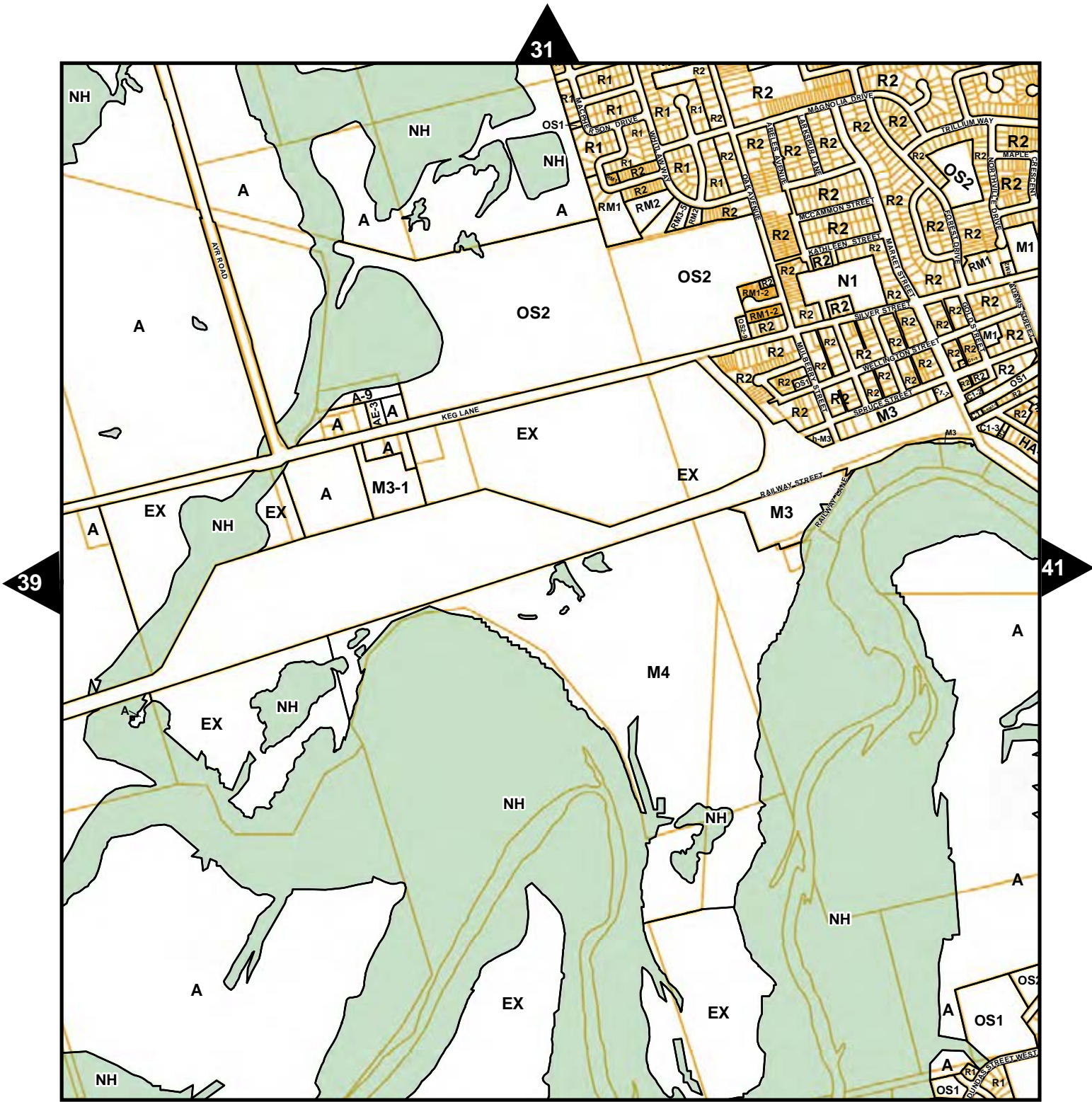

- Zoning
- Natural Heritage
- Parcel Fabric

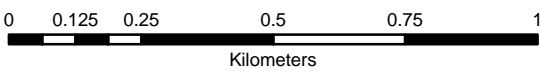

ZONING BY-LAW
SCHEDULE 'A'
Map No. 40



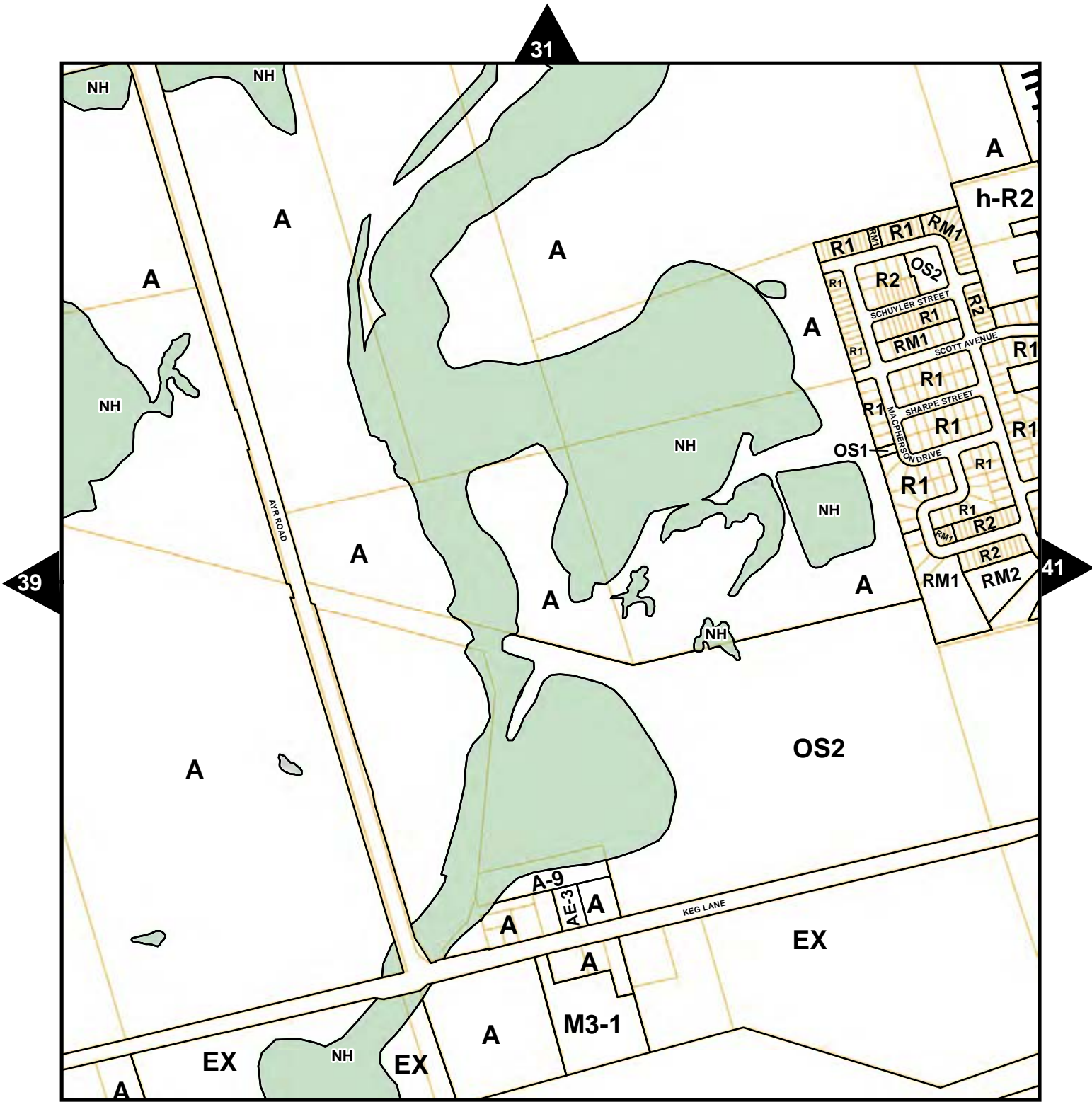

- Zoning
- Natural Hazard
- Parcel Fabric

ZONING BY-LAW
SCHEDULE 'A'
Map No.40A

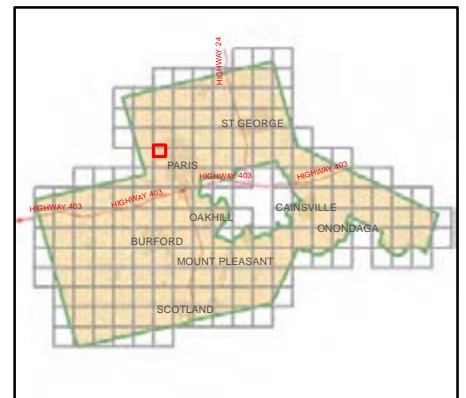
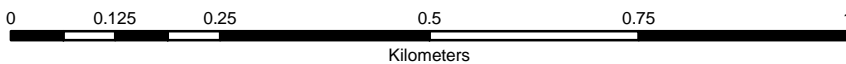

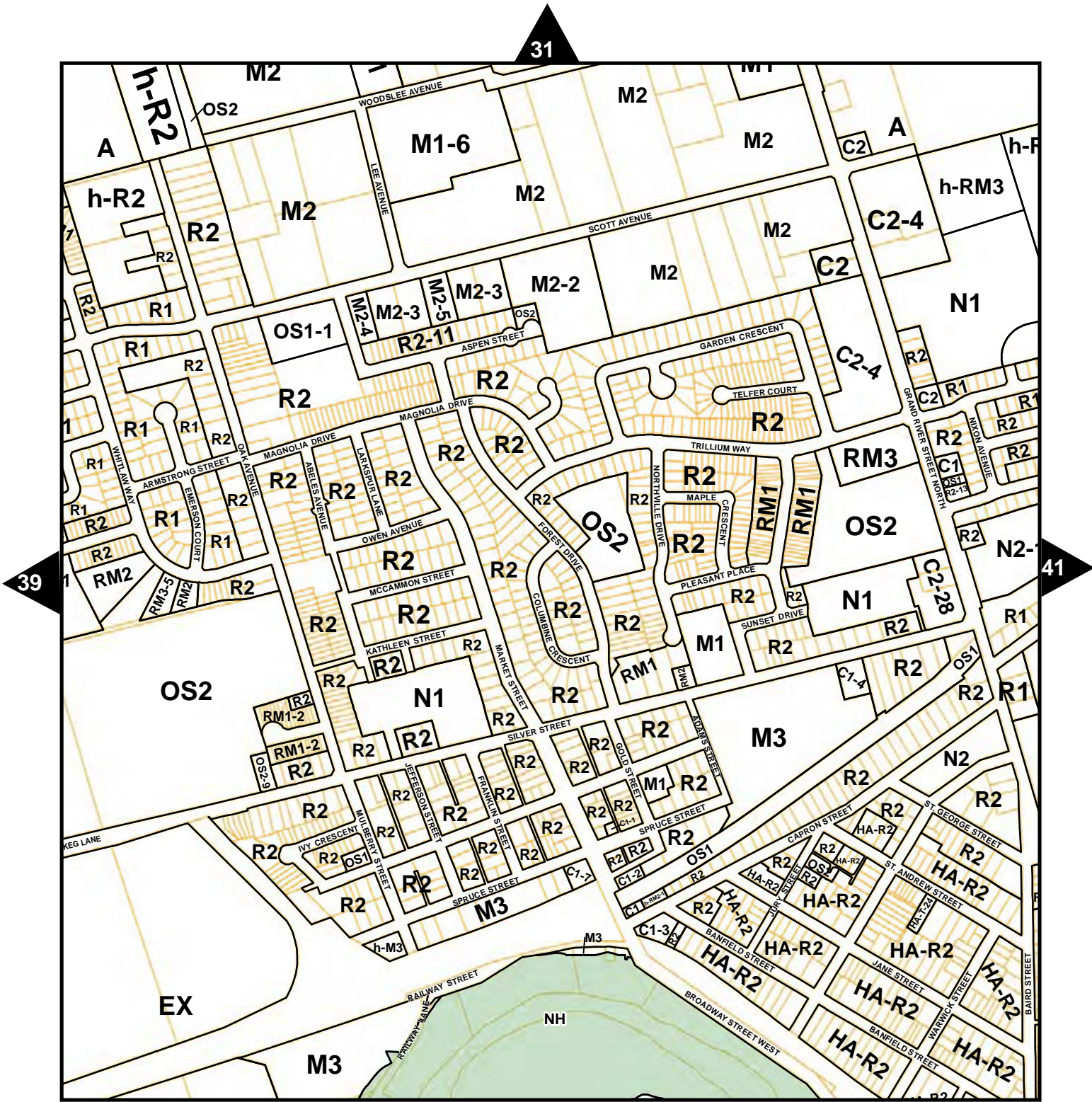

- Zoning
- Natural Hazard
- Parcel Fabric

ZONING BY-LAW
 SCHEDULE 'A'
Map No.40B

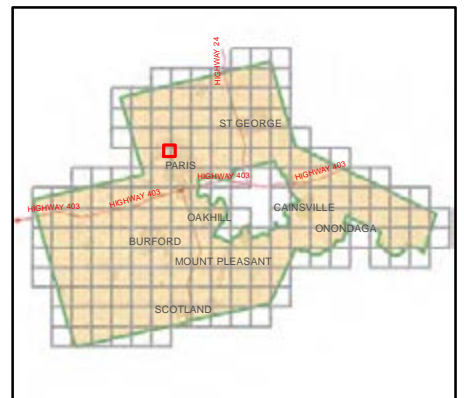
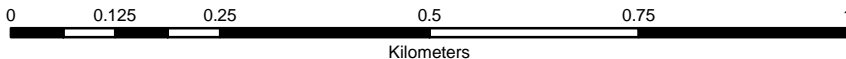

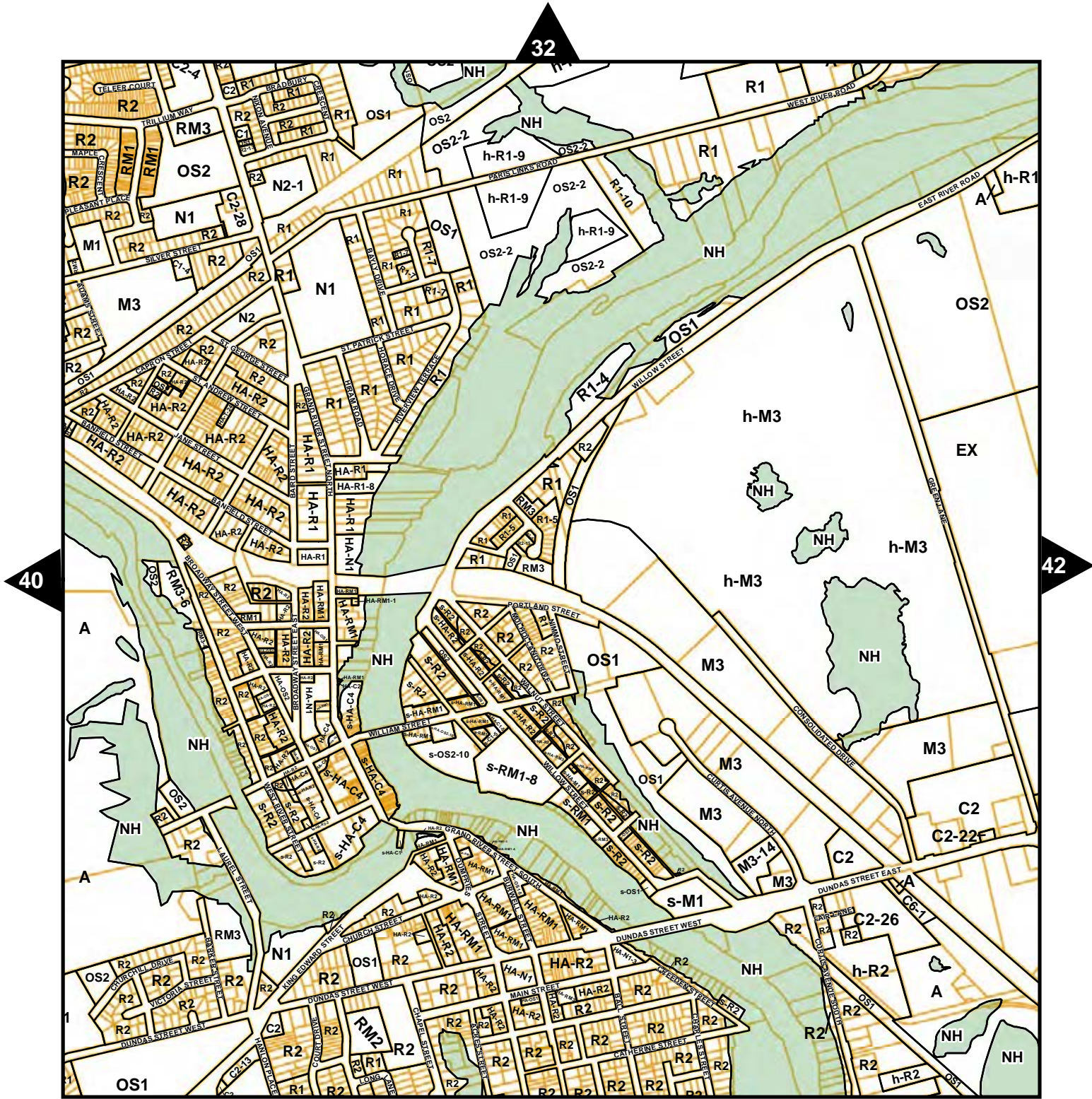

- Zoning
- Natural Heritage
- Parcel Fabric



ZONING BY-LAW
SCHEDULE 'A'
Map No. 41



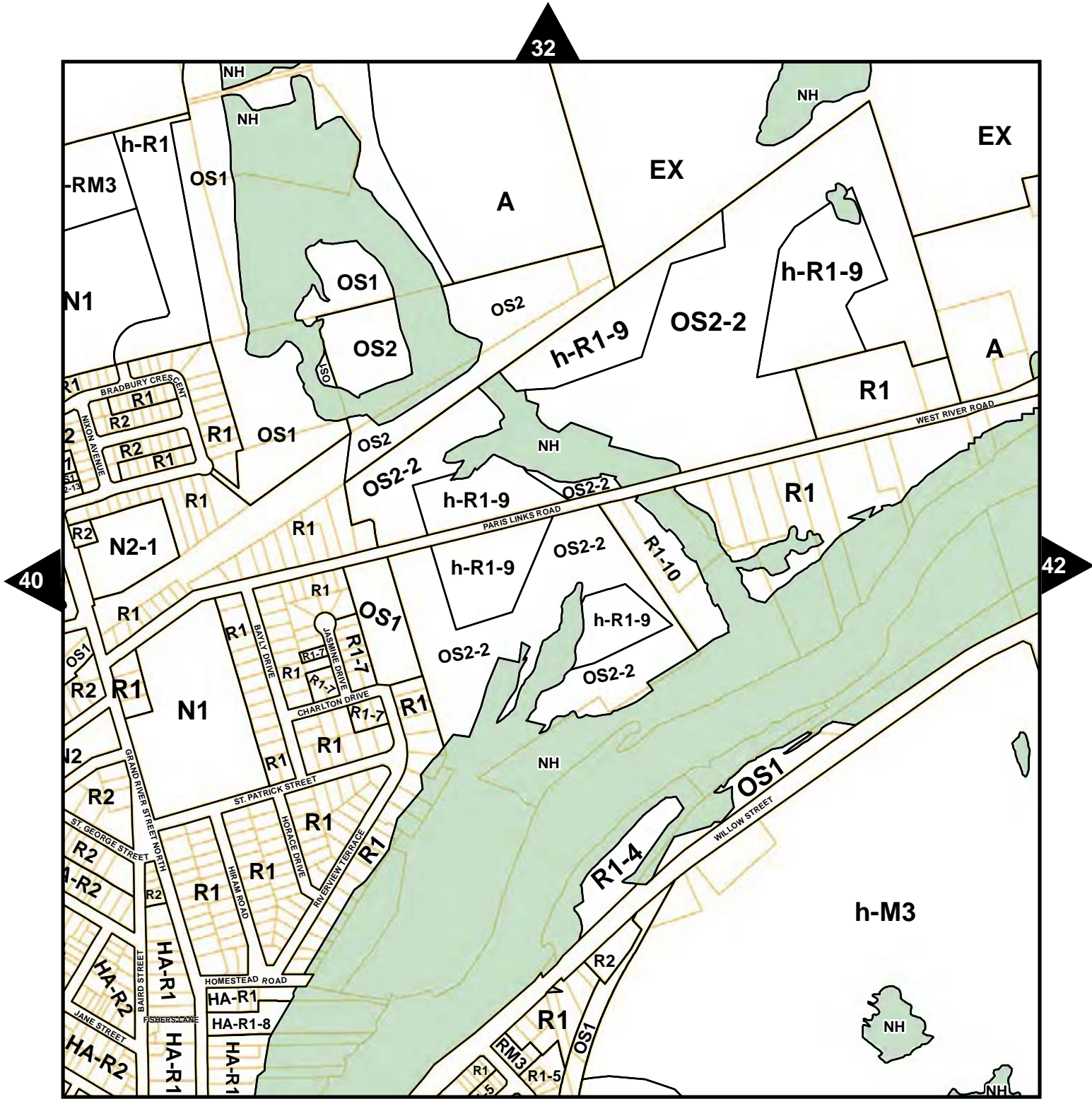

- Zoning
- Natural Hazard
- Parcel Fabric

ZONING BY-LAW
SCHEDULE 'A'
Map No.41A

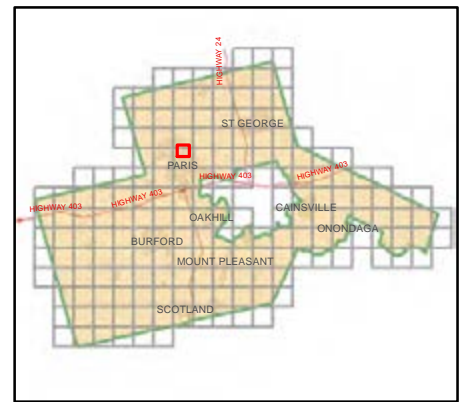
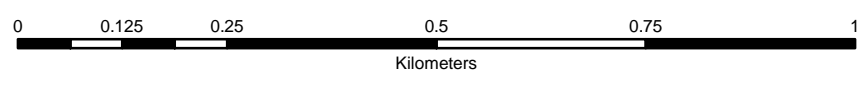

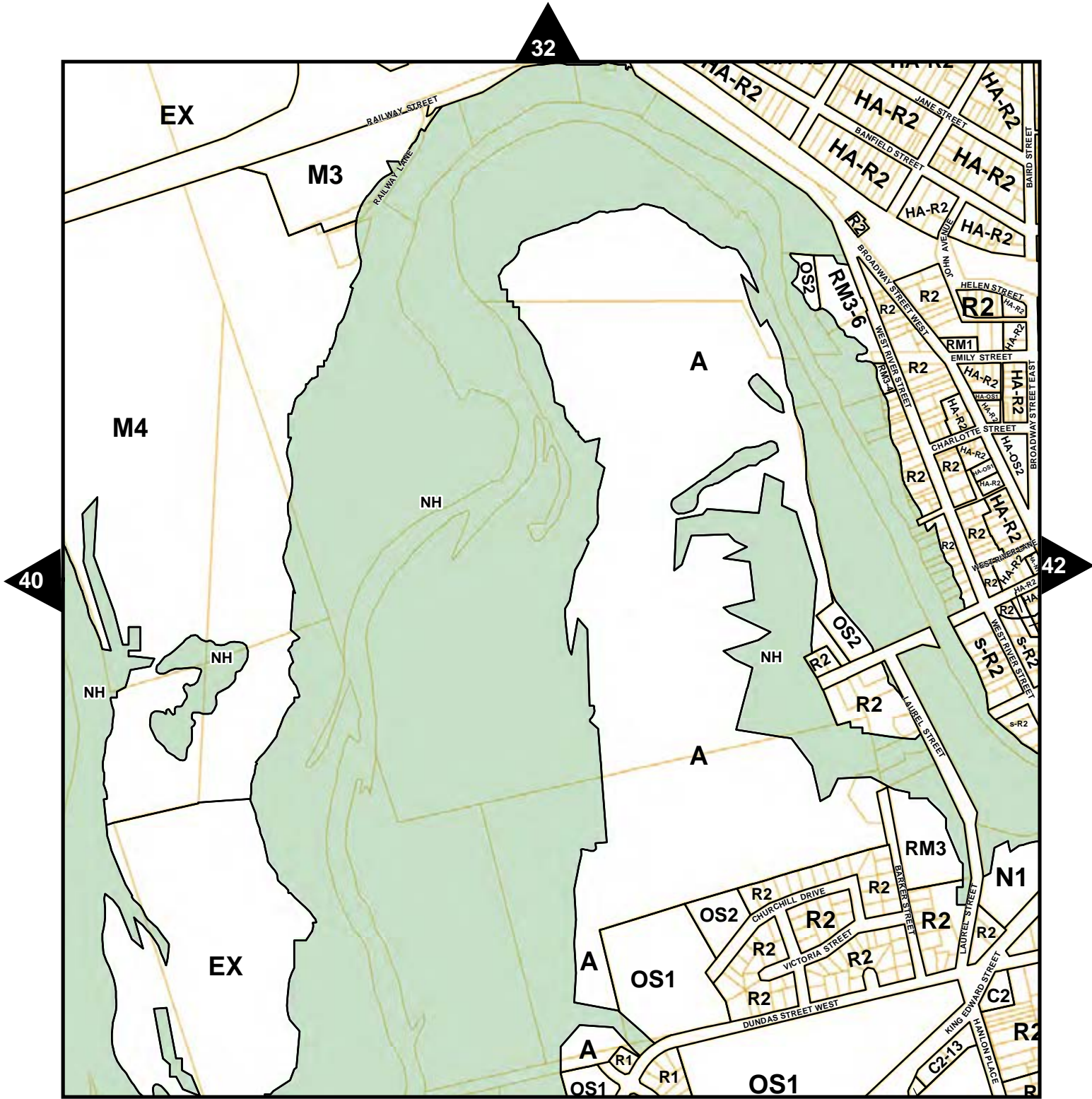

- Zoning
- Natural Hazard
- Parcel Fabric

ZONING BY-LAW
SCHEDULE 'A'
Map No.41B

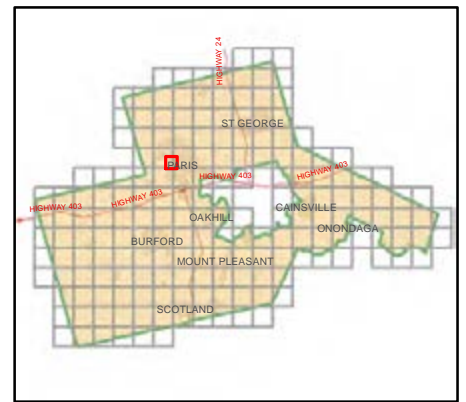
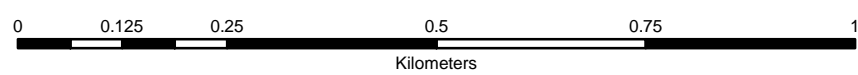

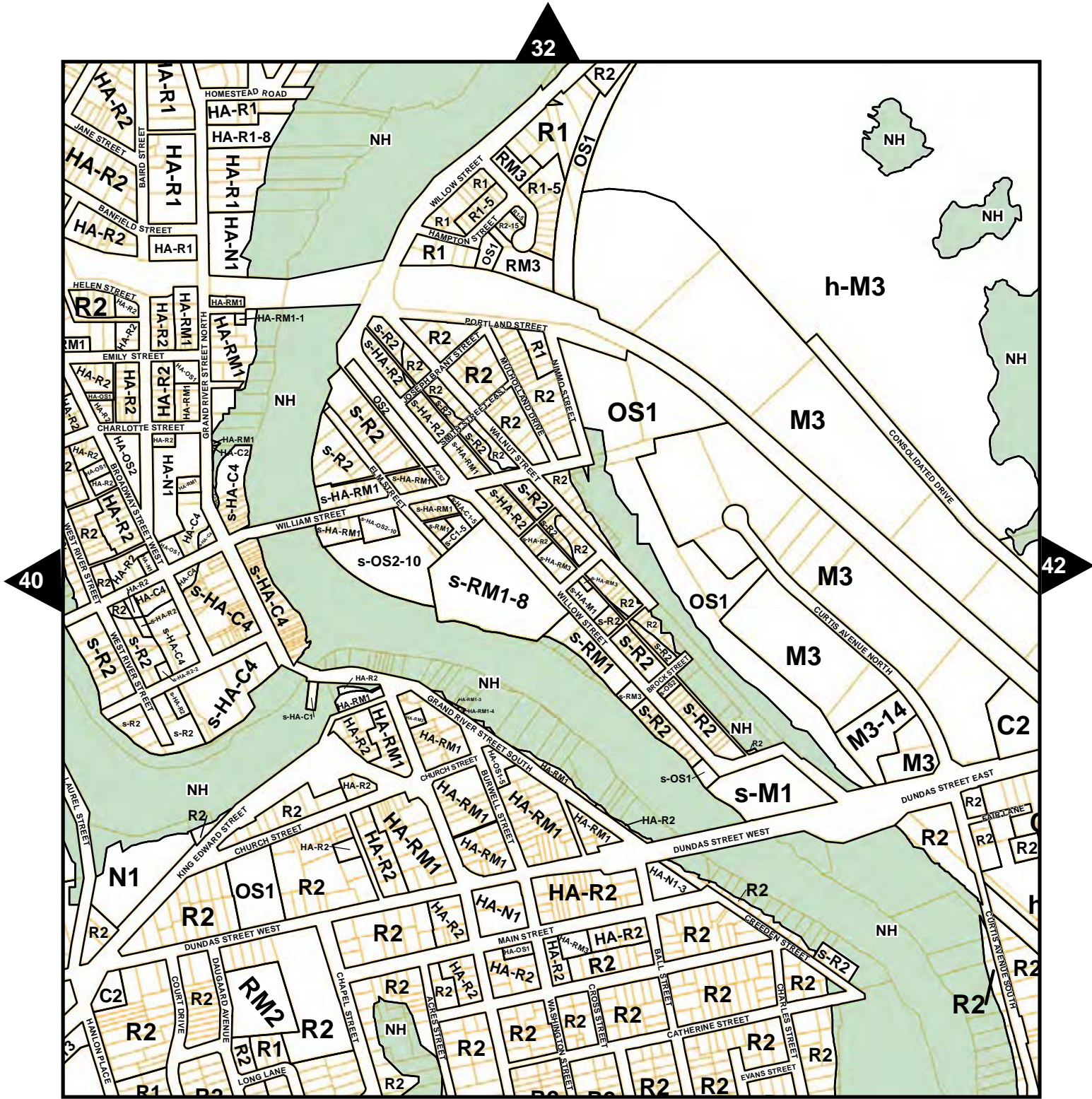

ZONING BY-LAW
SCHEDULE 'A'
Map No.41C

- Zoning
- Natural Hazard
- Parcel Fabric

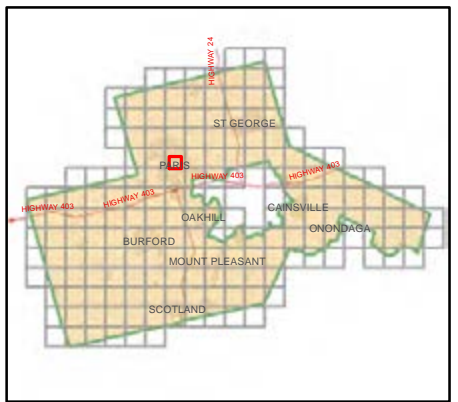
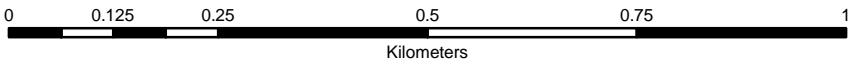

33

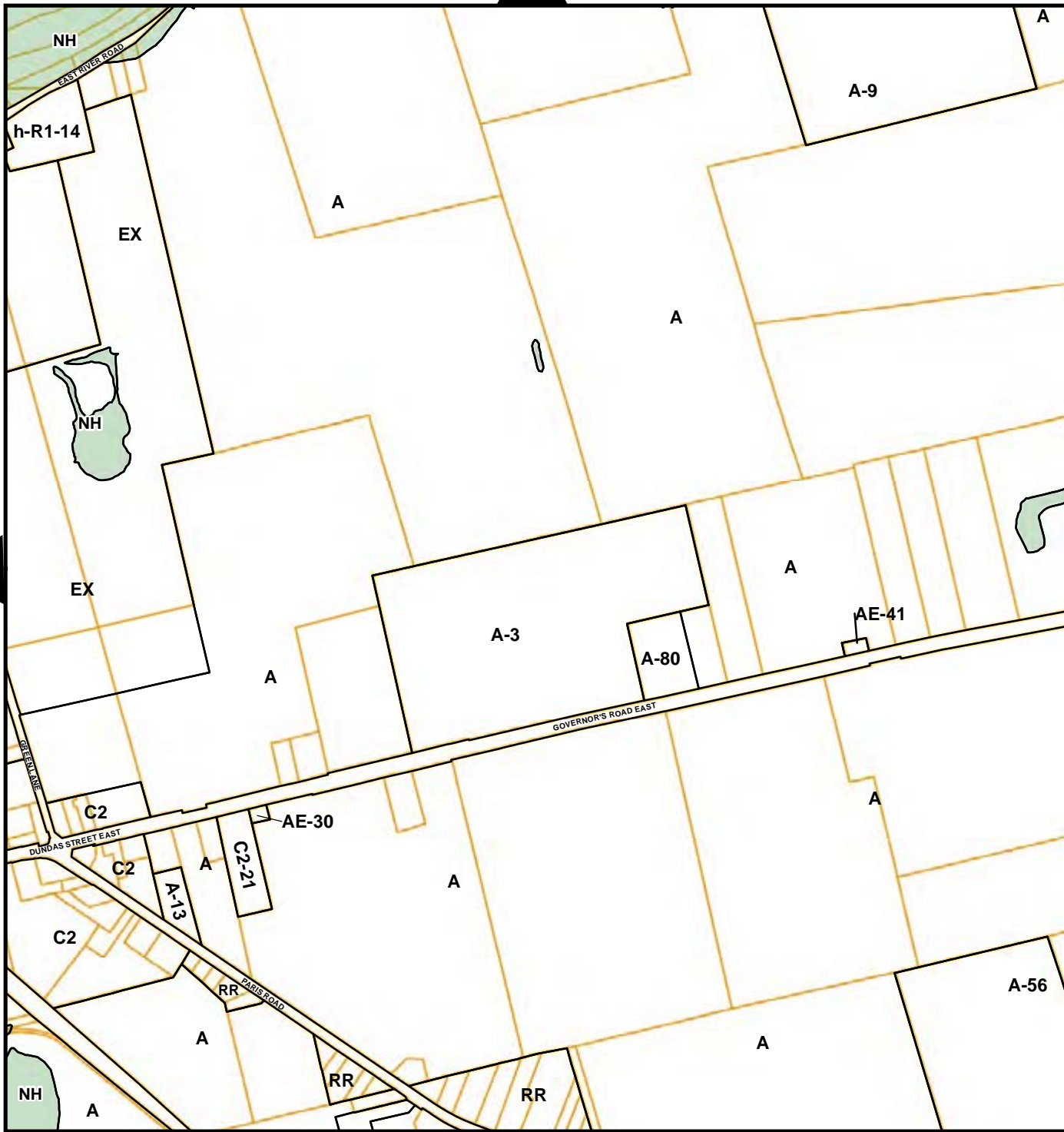

41

43

56



- Zoning
- Natural Heritage
- Parcel Fabric

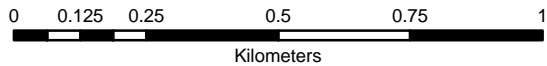

ZONING BY-LAW SCHEDULE 'A' Map No. 42



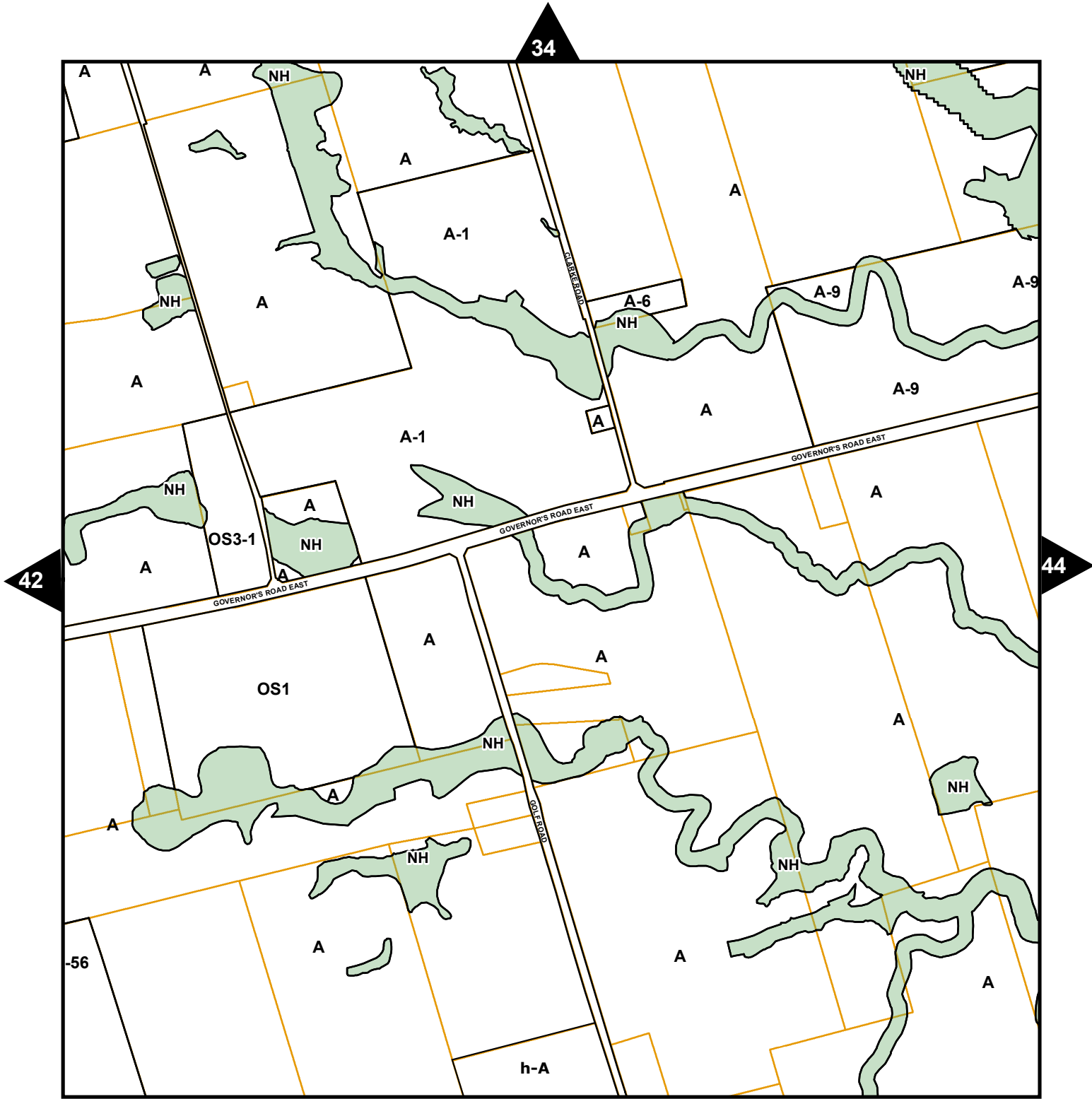

- Zoning
- Natural Heritage
- Parcel Fabric

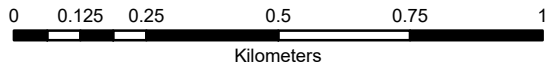

ZONING BY-LAW SCHEDULE 'A' Map No. 43

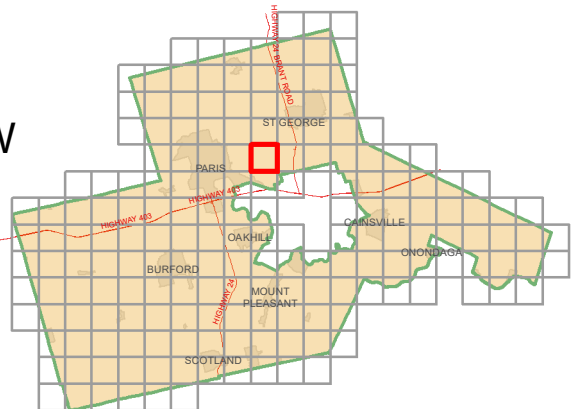

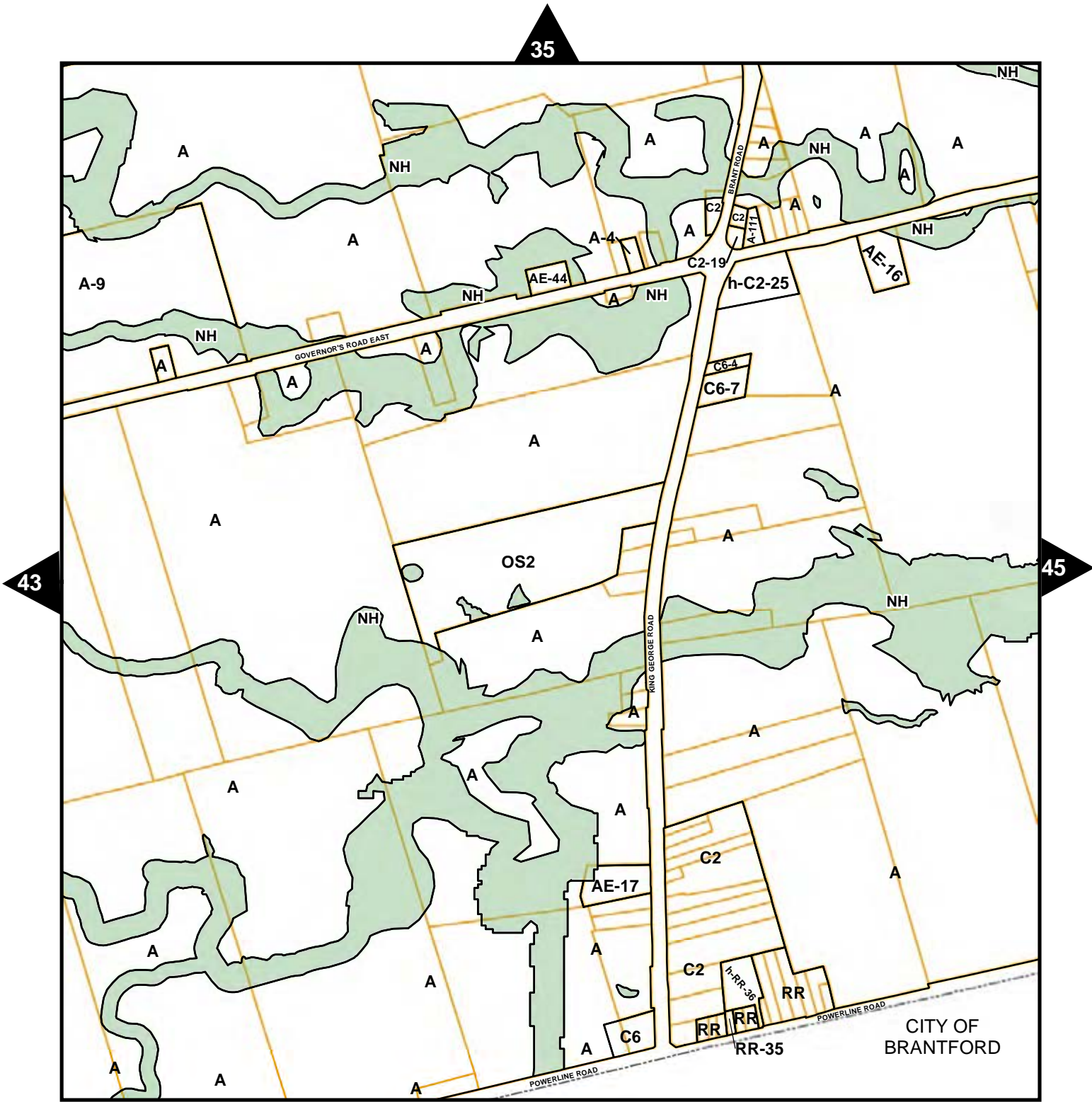

- Zoning
- Natural Heritage
- Parcel Fabric

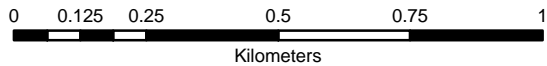

ZONING BY-LAW SCHEDULE 'A' Map No. 44



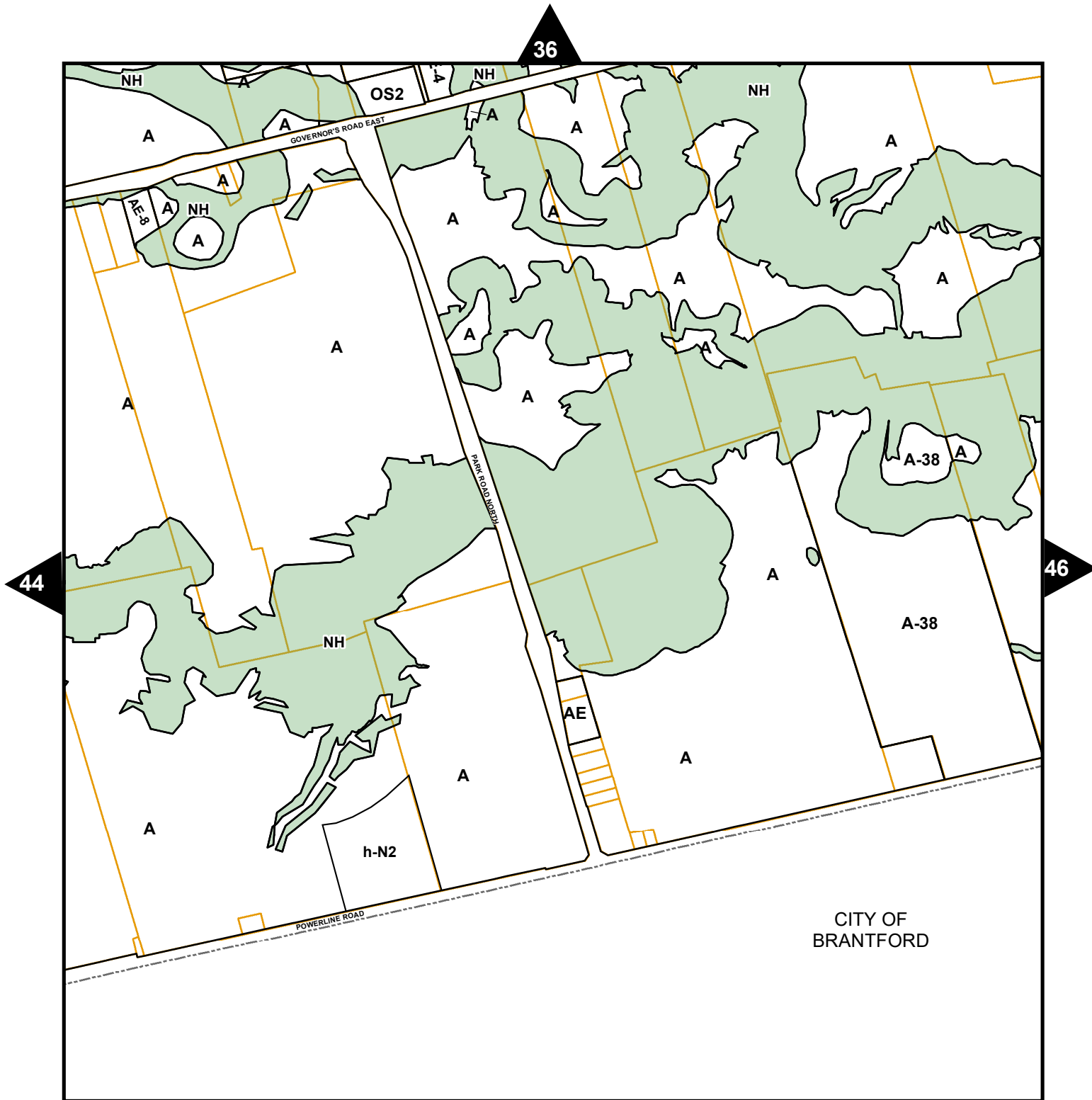

CITY OF BRANTFORD



- Zoning
- Natural Heritage
- Parcel Fabric

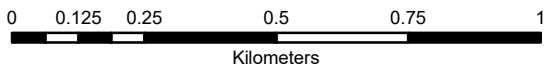

ZONING BY-LAW SCHEDULE 'A' Map No. 45

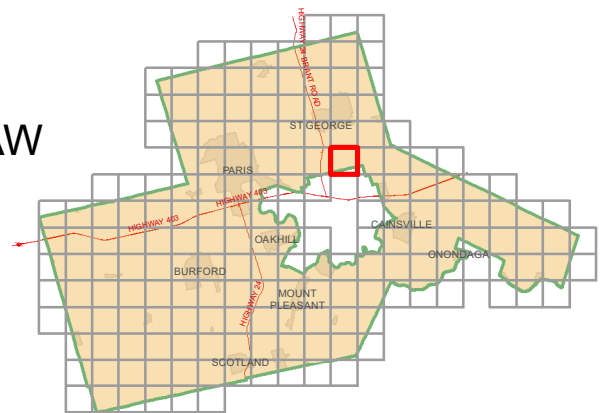

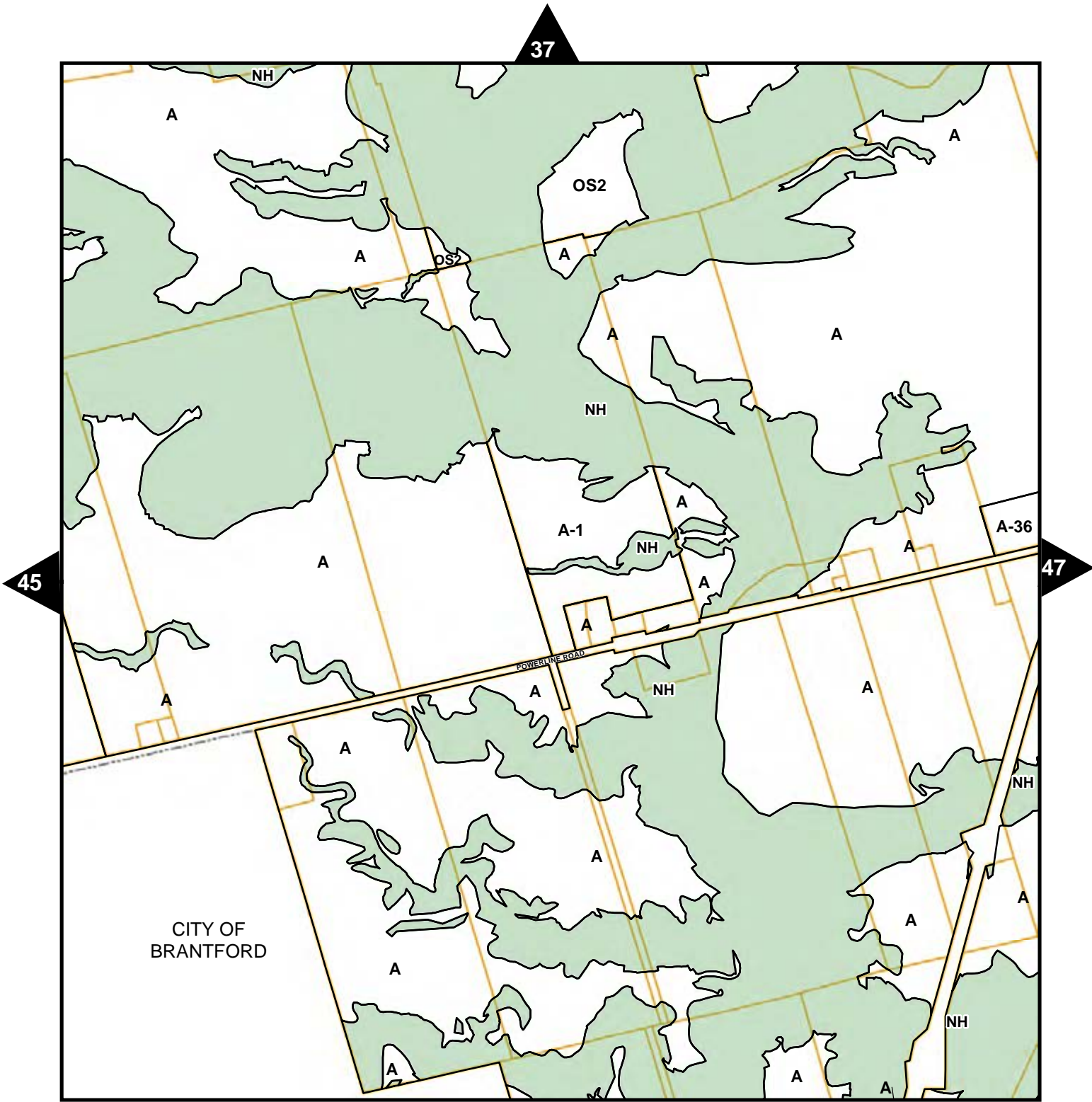

- Zoning
- Natural Heritage
- Parcel Fabric

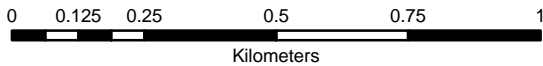

ZONING BY-LAW
SCHEDULE 'A'
Map No. 46

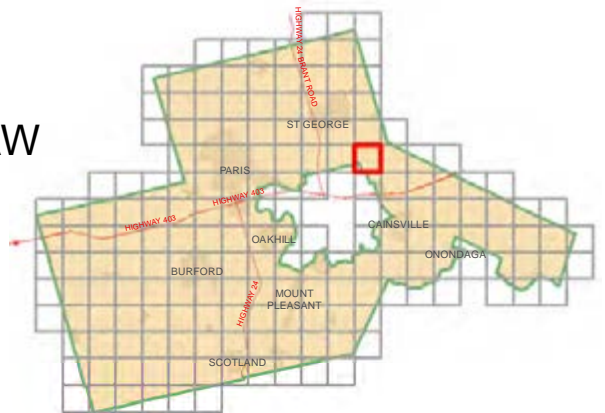

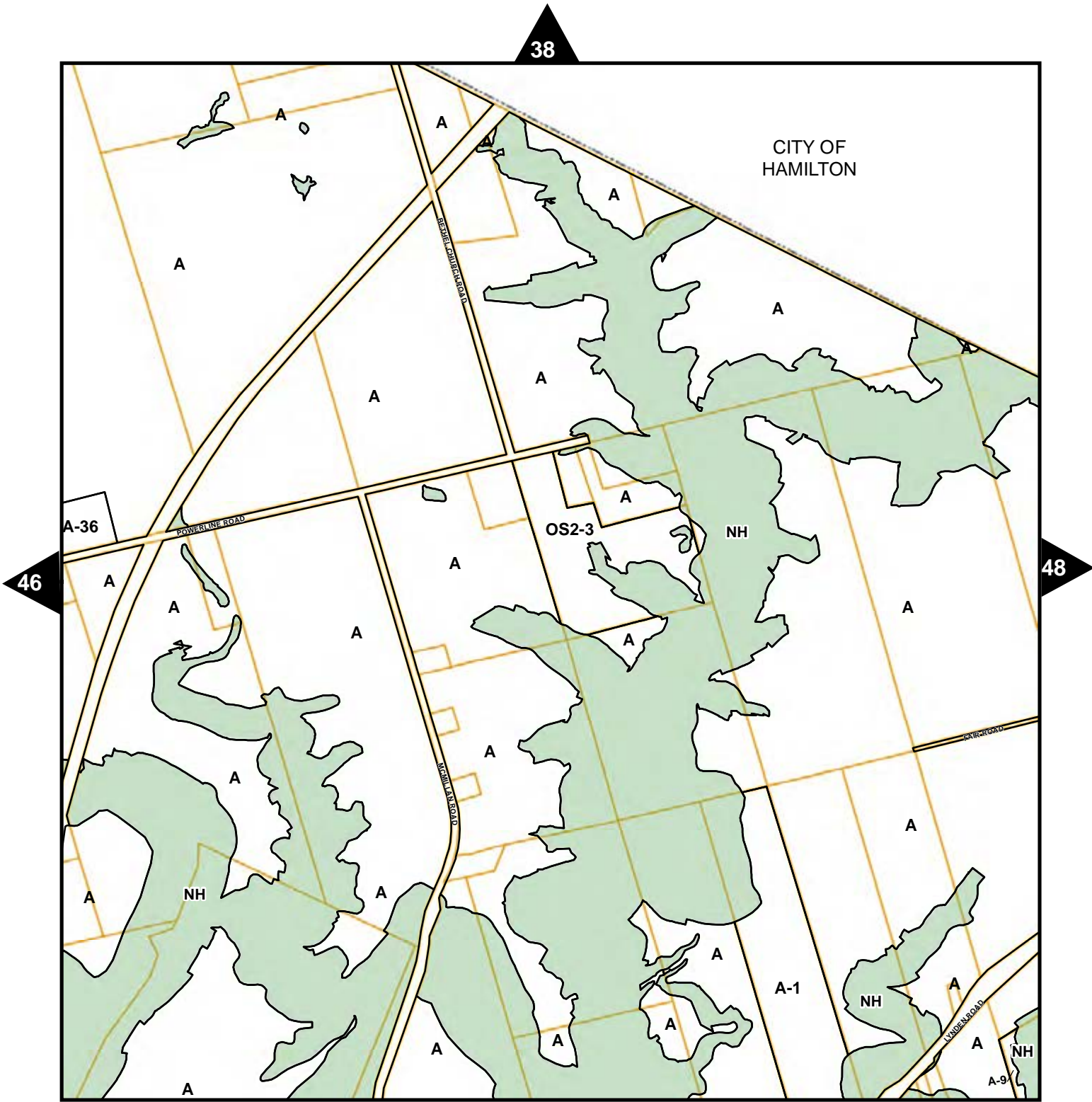

- Zoning
- Natural Heritage
- Parcel Fabric

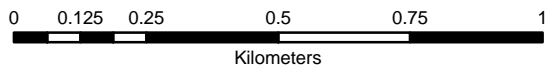

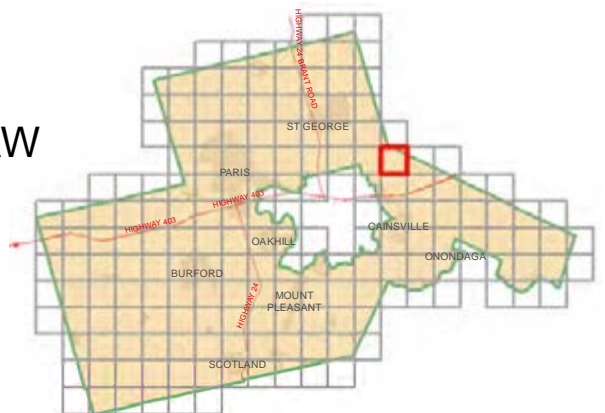

ZONING BY-LAW SCHEDULE 'A' Map No. 47

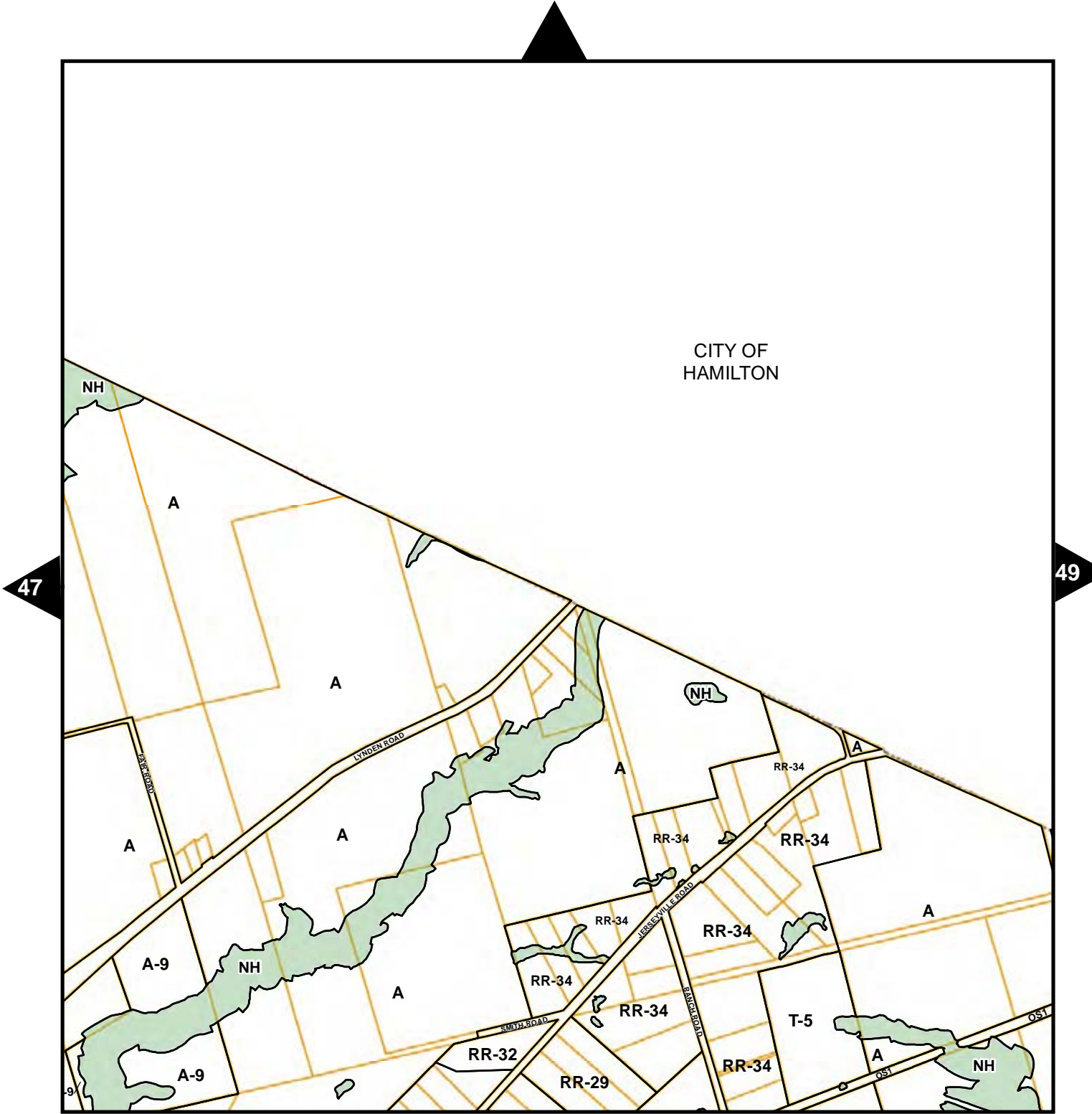



CITY OF
HAMILTON



-  Zoning
-  Natural Heritage
-  Parcel Fabric

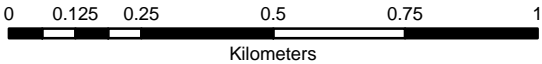

ZONING BY-LAW
SCHEDULE 'A'
Map No. 48





CITY OF
HAMILTON

48

62



-  Zoning
-  Natural Heritage
-  Parcel Fabric

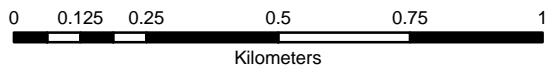

ZONING BY-LAW
SCHEDULE 'A'
Map No. 49





COUNTY OF
OXFORD

51

67



-  Zoning
-  Natural Heritage
-  Parcel Fabric

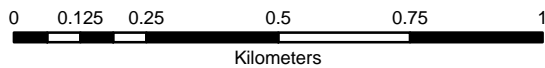

ZONING BY-LAW SCHEDULE 'A' Map No. 50



COUNTY OF
OXFORD

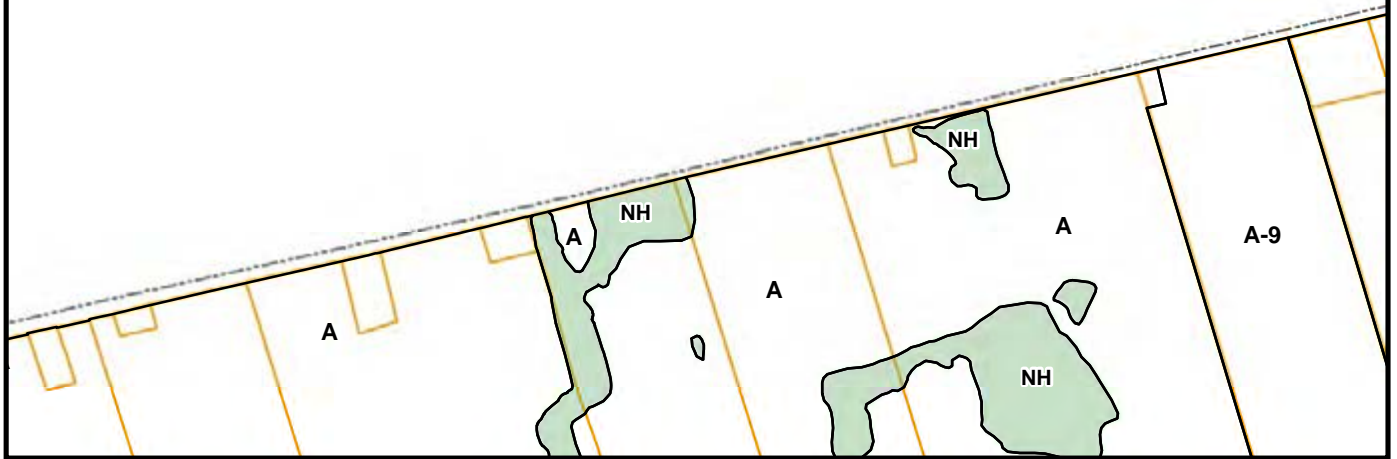

50

52



68



-  Zoning
-  Natural Heritage
-  Parcel Fabric

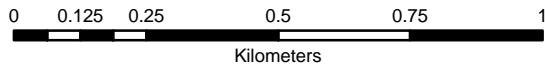

ZONING BY-LAW
SCHEDULE 'A'
Map No. 51



COUNTY OF OXFORD

51

53

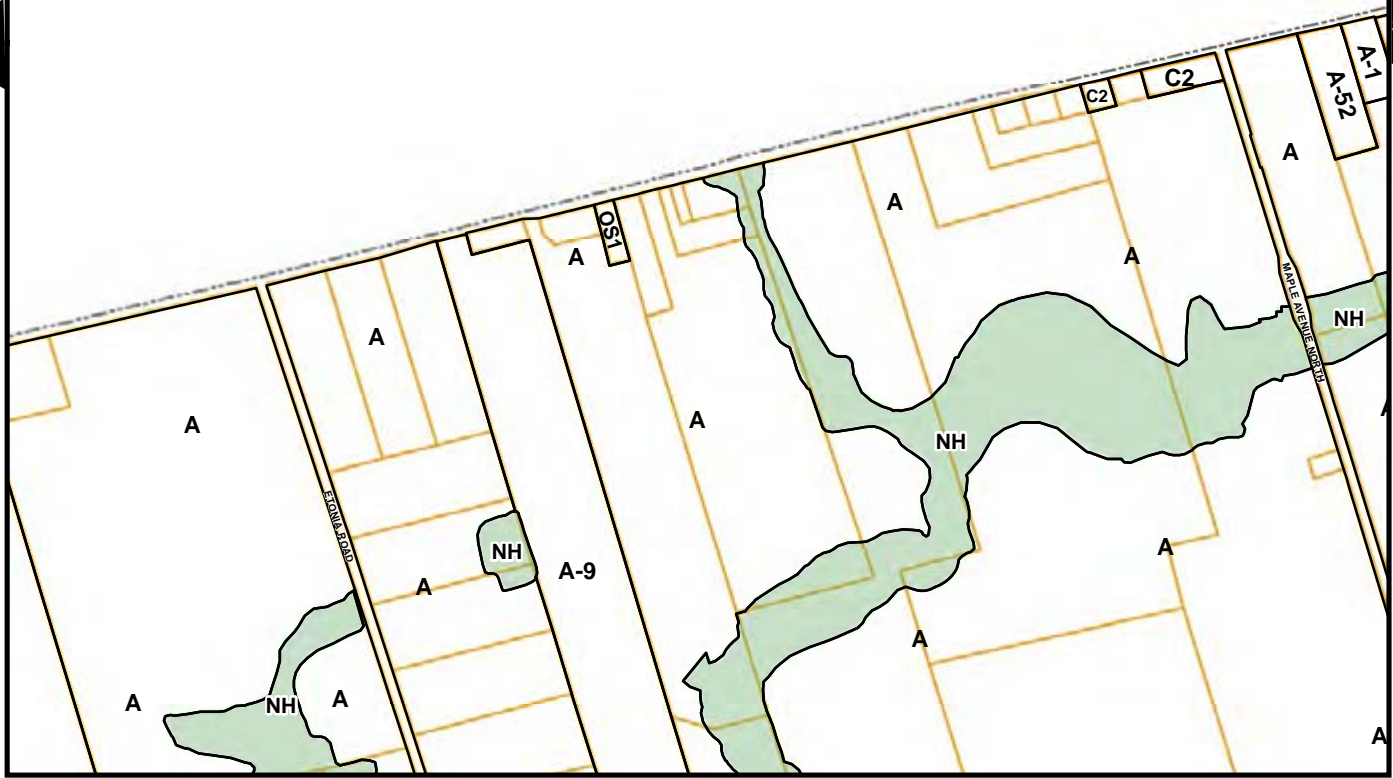



69



ZONING BY-LAW

SCHEDULE 'A'

Map No. 52

-  Zoning
-  Natural Heritage
-  Parcel Fabric

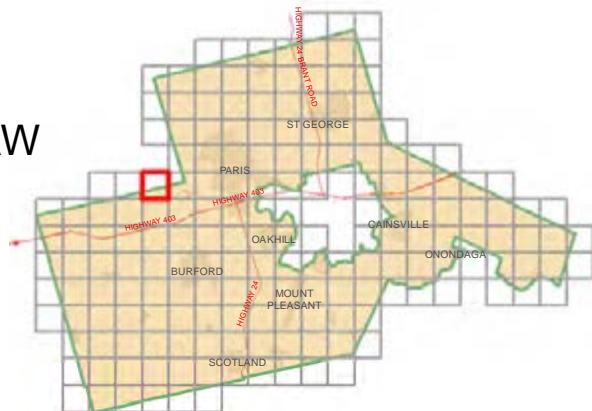
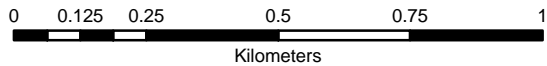

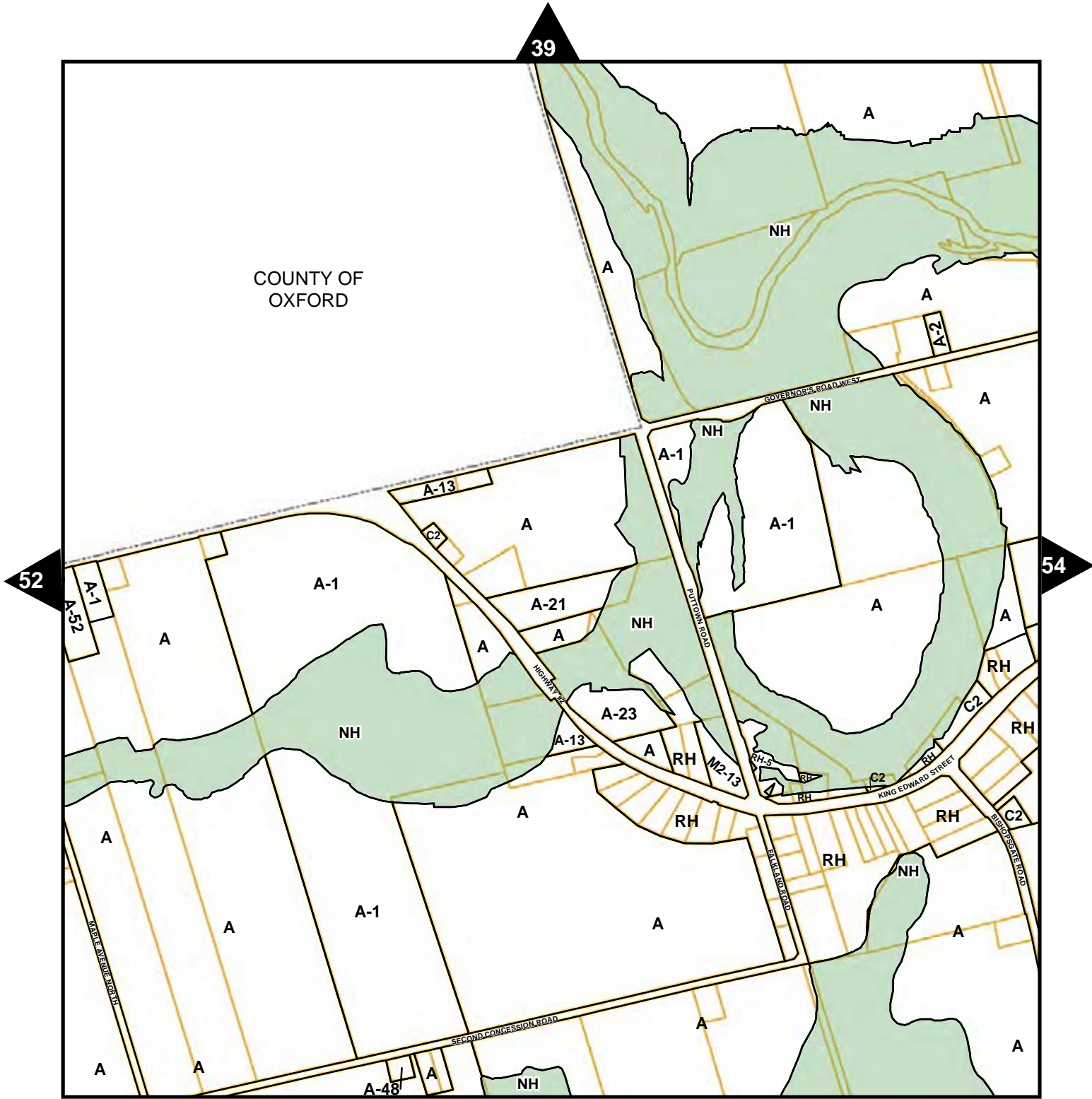

- Zoning
- Natural Heritage
- Parcel Fabric

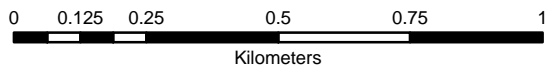

ZONING BY-LAW SCHEDULE 'A' Map No. 53

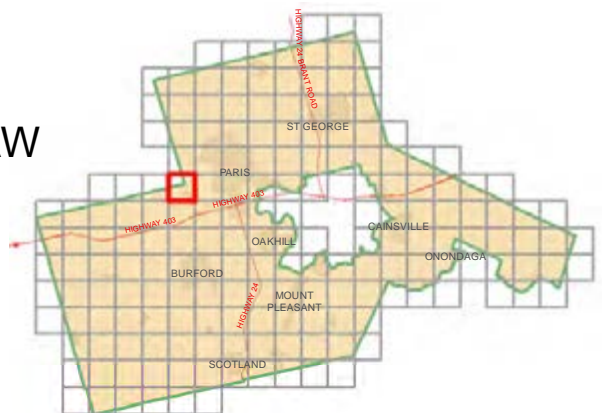

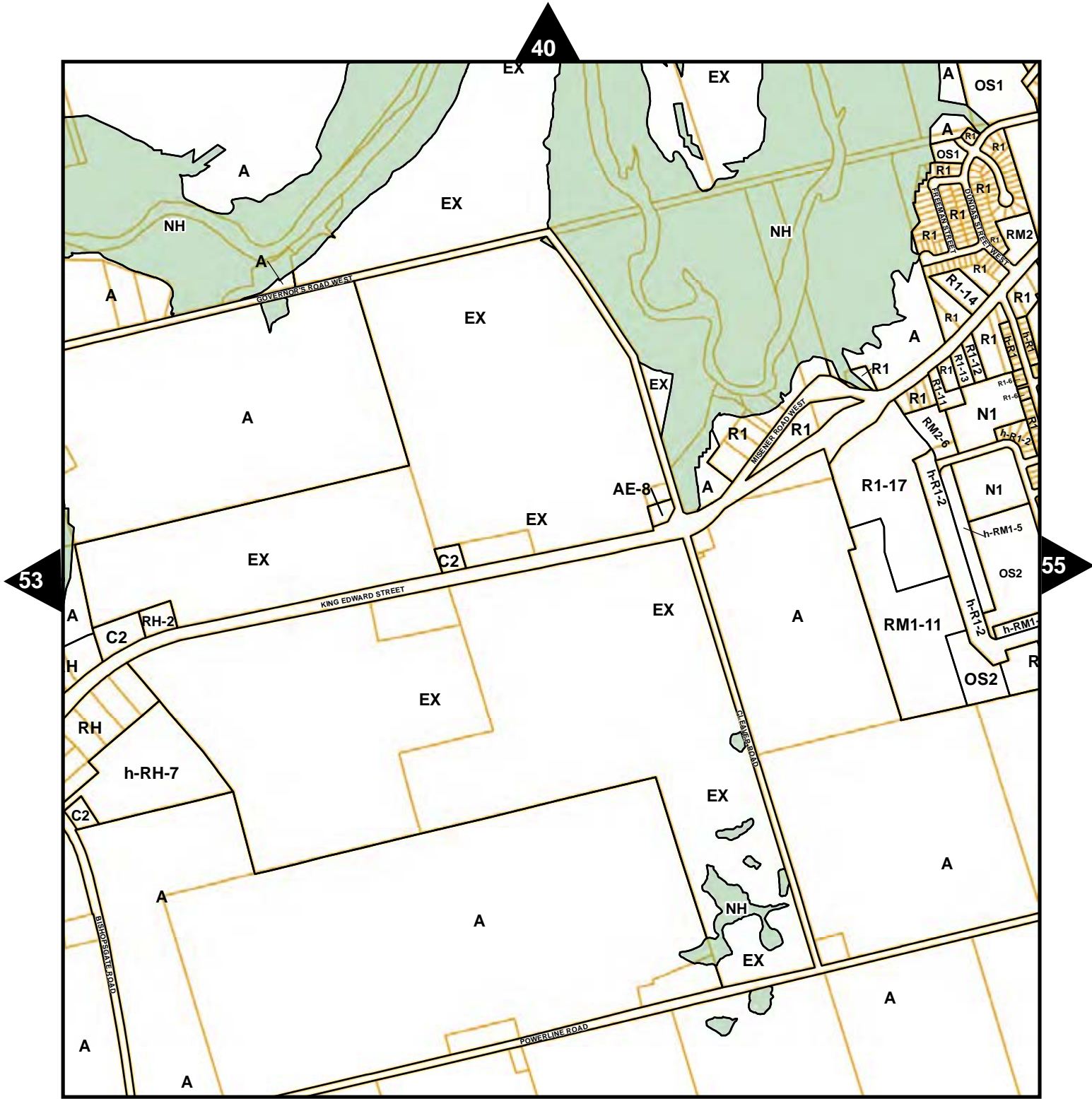

- Zoning
- Natural Heritage
- Parcel Fabric



ZONING BY-LAW
SCHEDULE 'A'
Map No. 54



71

40

53

55

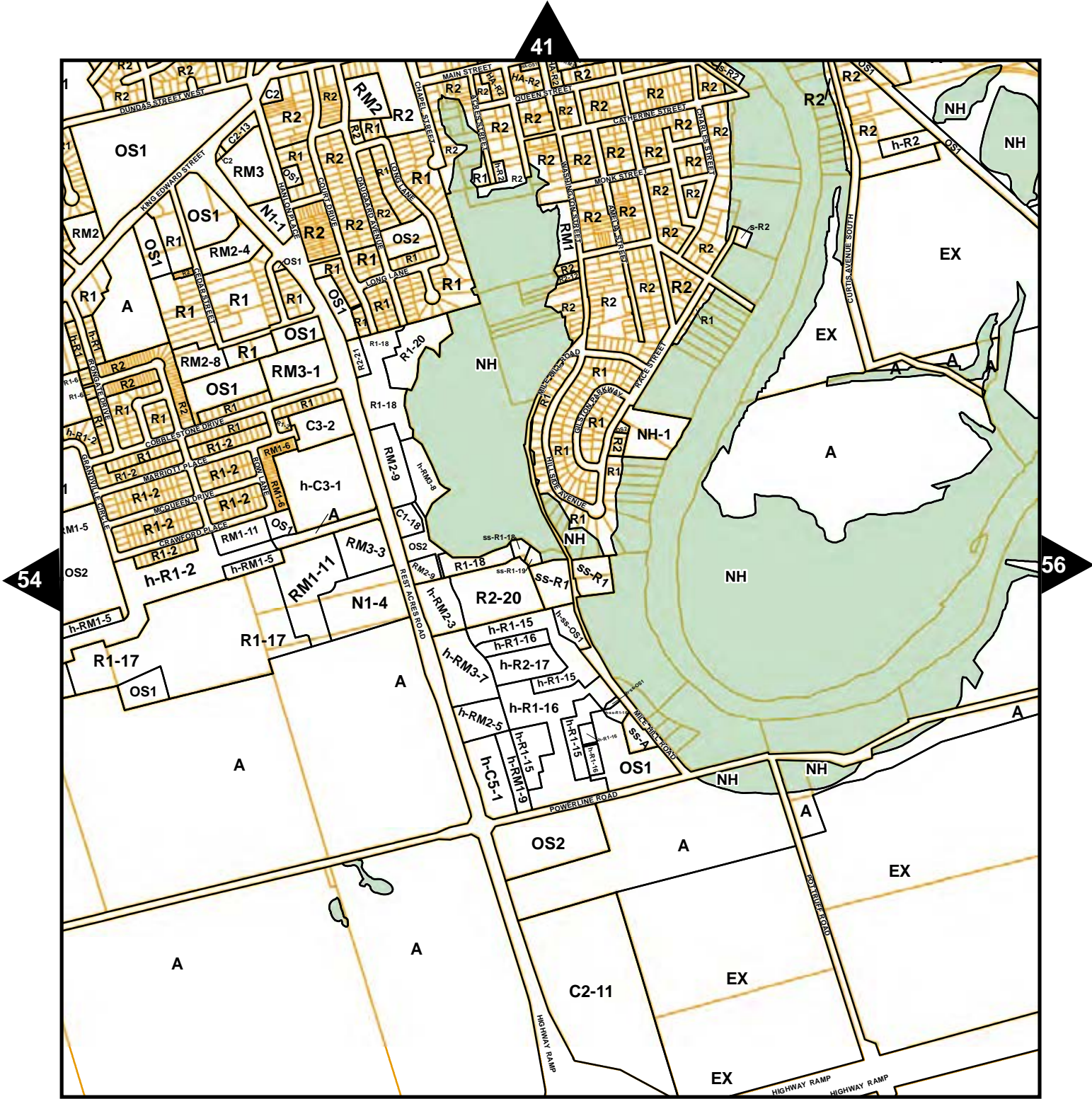

- Zoning
- Natural Heritage
- Parcel Fabric



ZONING BY-LAW

SCHEDULE 'A'

Map No. 55



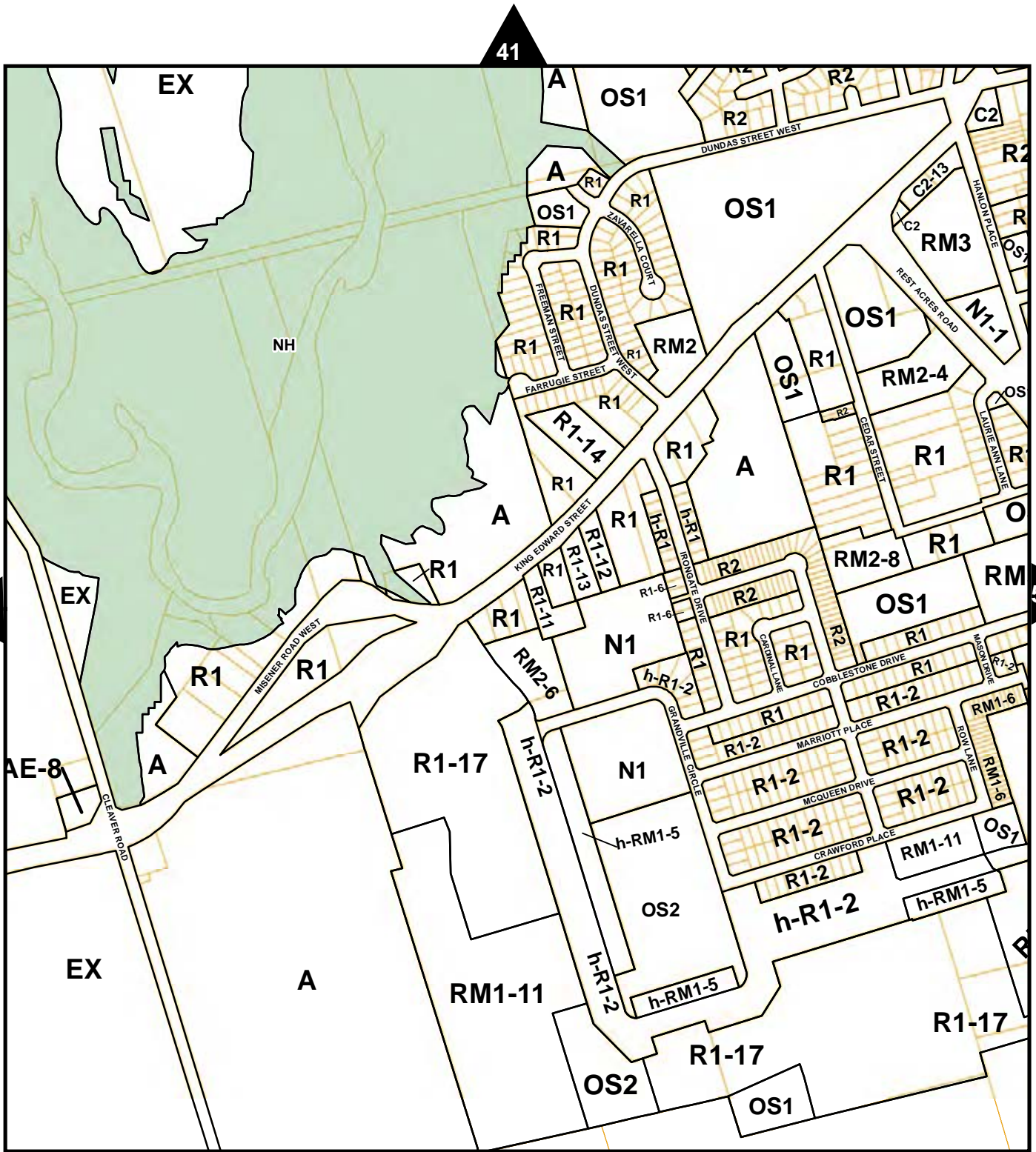

- Zoning
- Natural Hazard
- Parcel Fabric

ZONING BY-LAW
SCHEDULE 'A'
Map No.55A

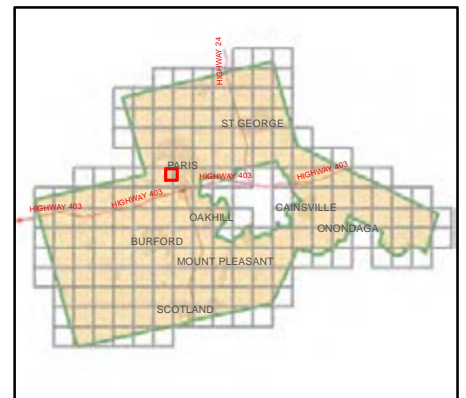
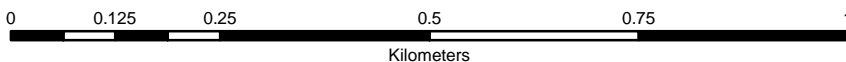

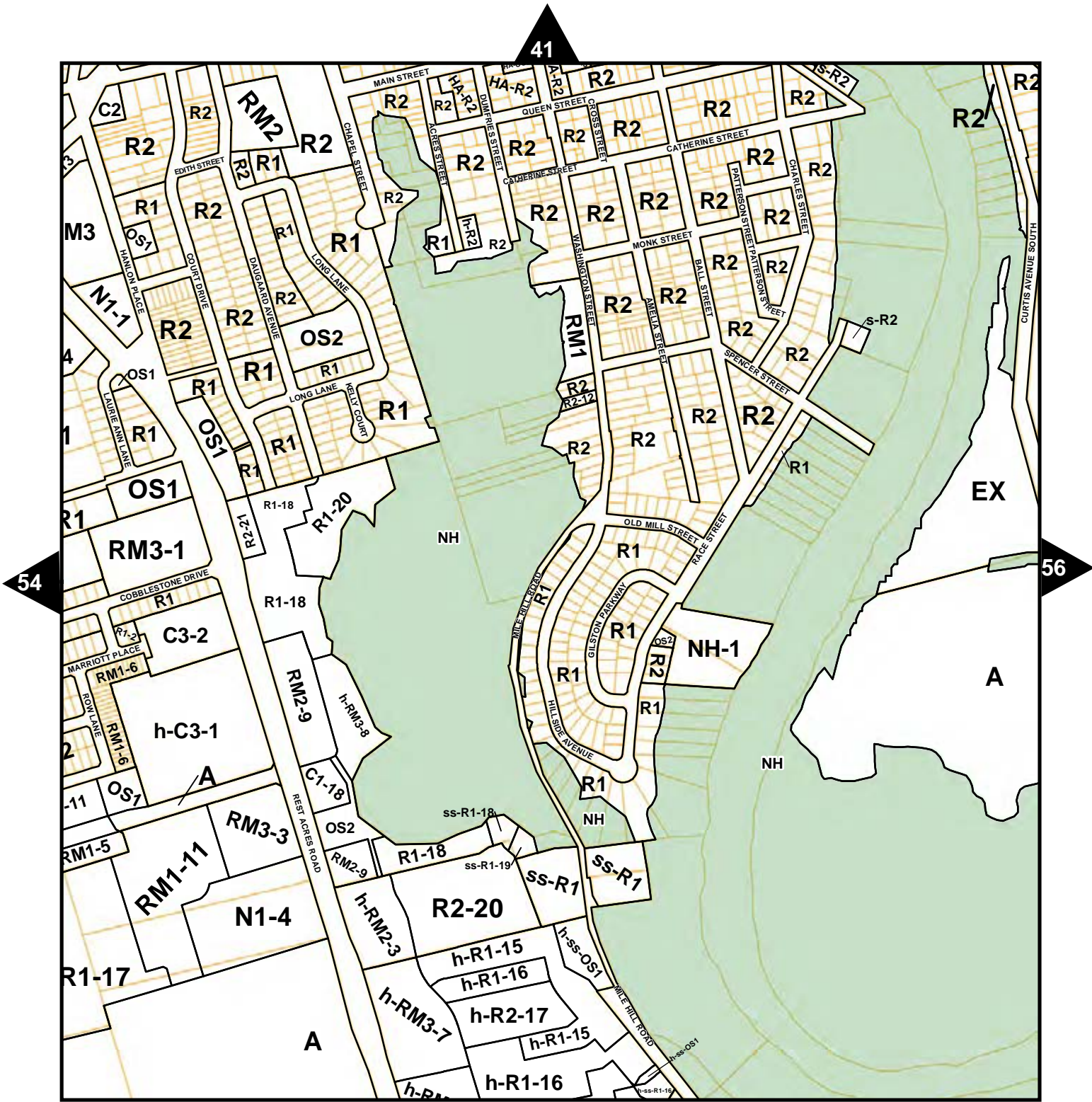

- Zoning
- Natural Hazard
- Parcel Fabric

ZONING BY-LAW
SCHEDULE 'A'
Map No. 10

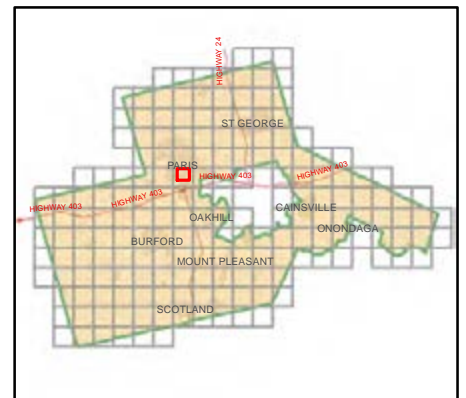
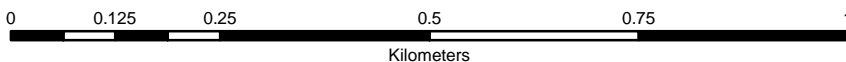

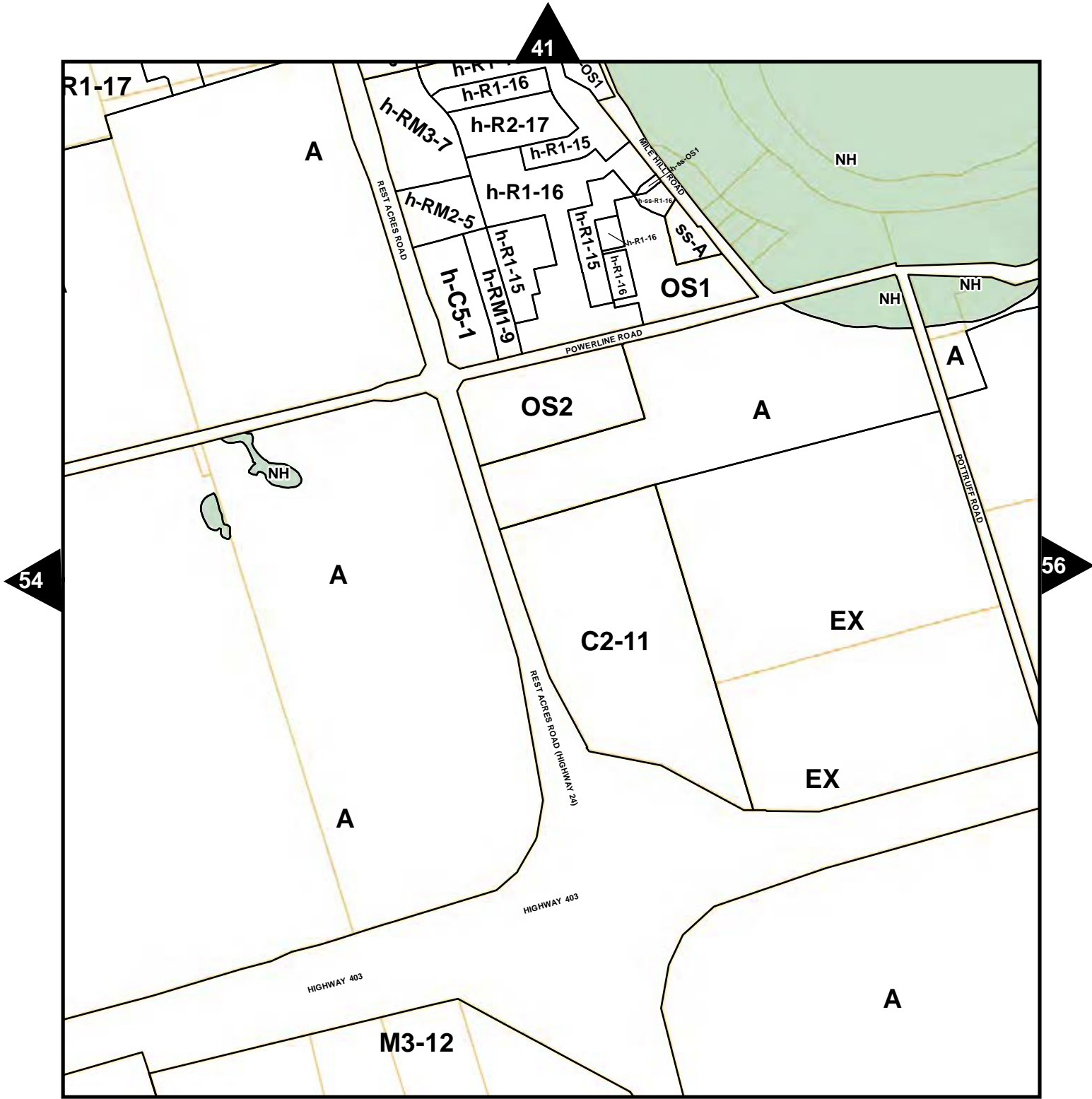

- Zoning
- Natural Hazard
- Parcel Fabric

ZONING BY-LAW
SCHEDULE 'A'
Map No.55C

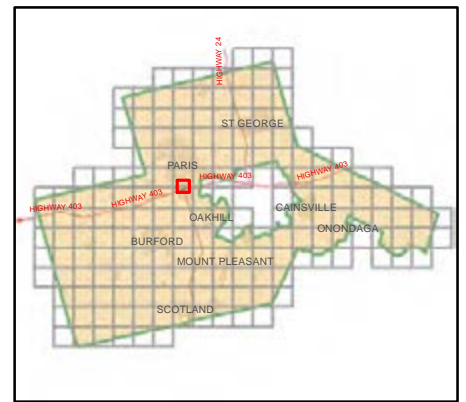
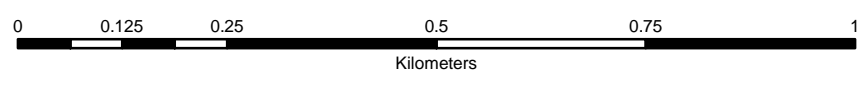

42

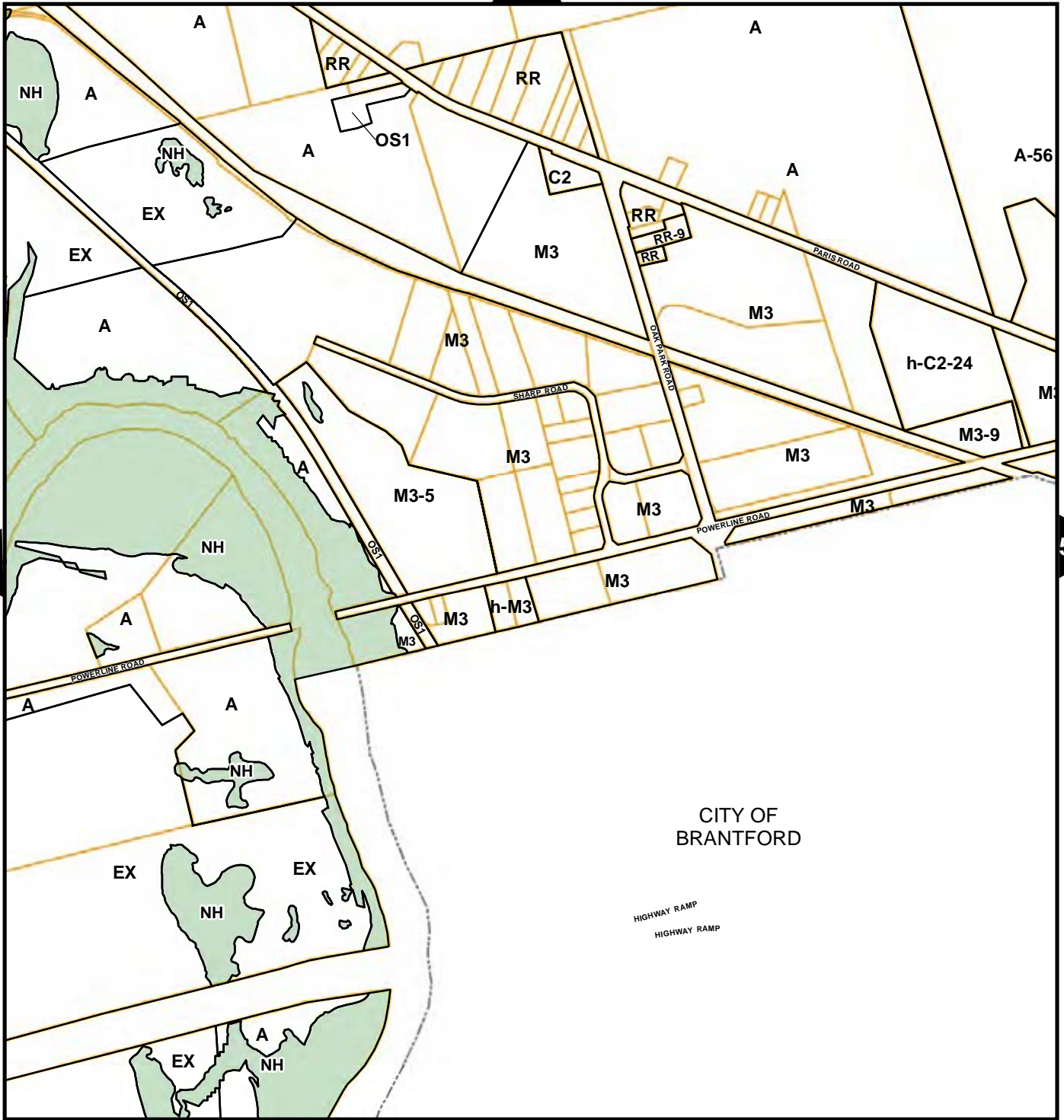



CITY OF BRANTFORD

HIGHWAY RAMP
HIGHWAY RAMP

73



ZONING BY-LAW
SCHEDULE 'A'
Map No. 56

-  Zoning
-  Natural Heritage
-  Parcel Fabric

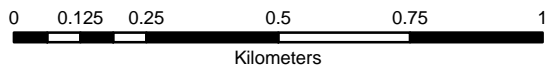

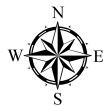
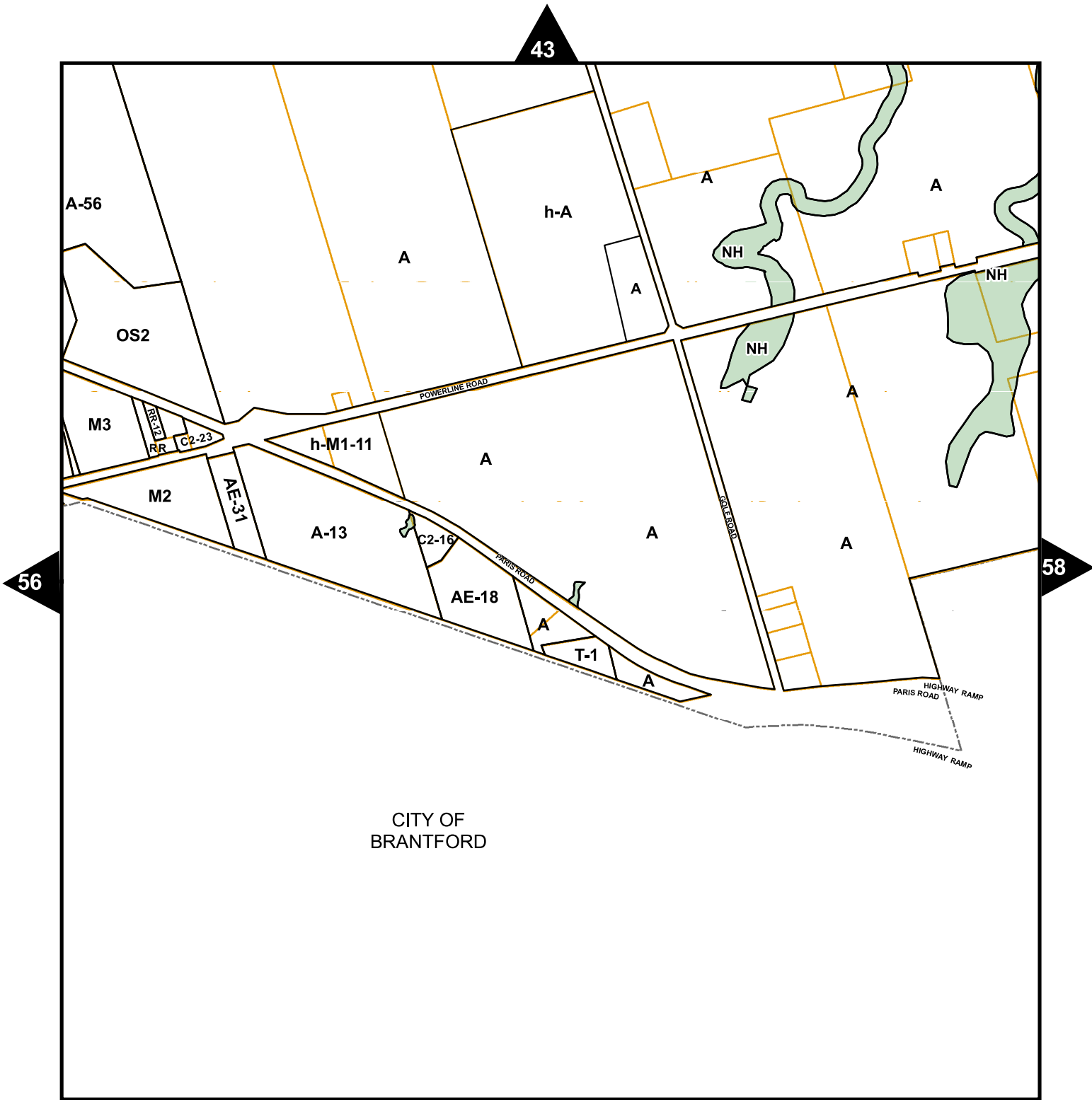

- Zoning
- Natural Heritage
- Parcel Fabric

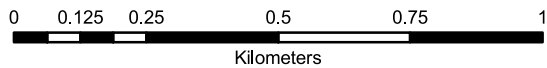

ZONING BY-LAW SCHEDULE 'A' Map No. 57

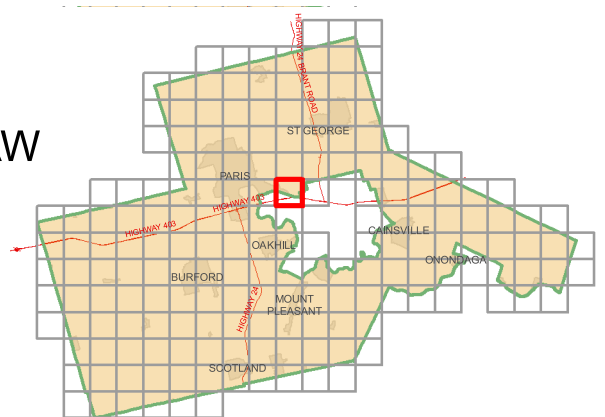

74

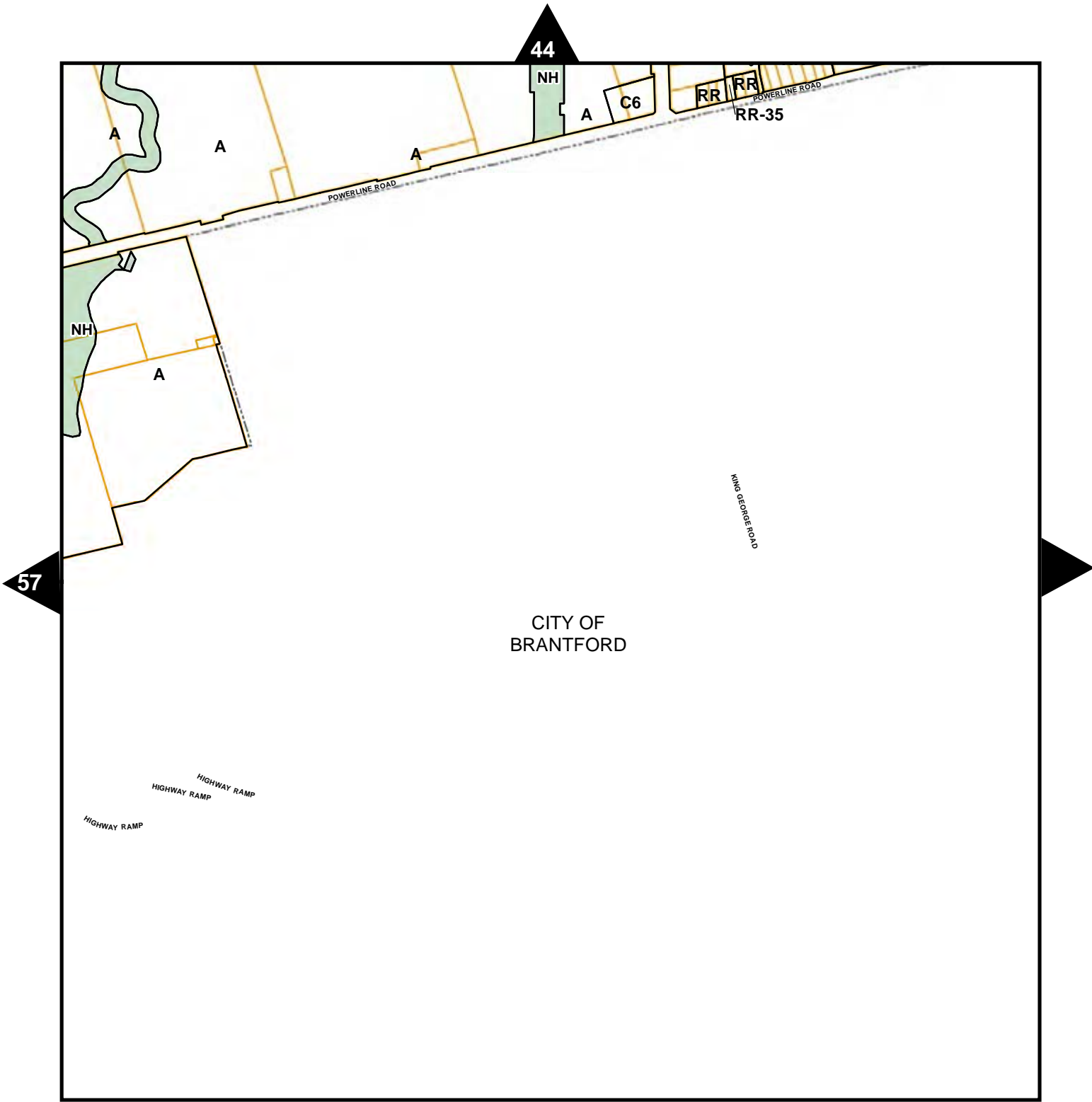



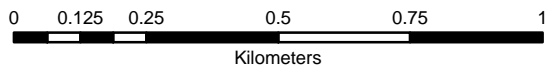

- Zoning
- Natural Heritage
- Parcel Fabric

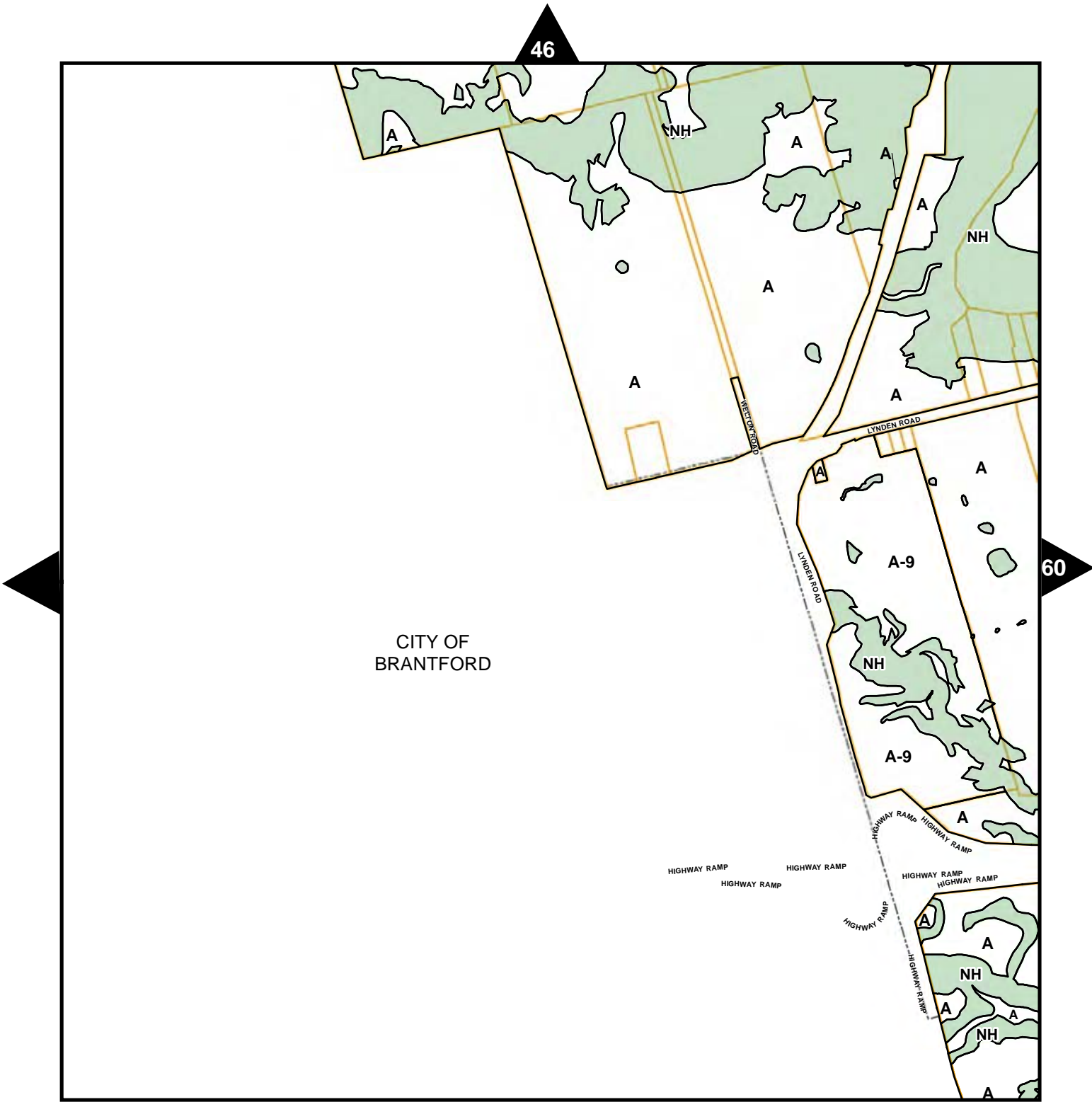

ZONING BY-LAW SCHEDULE 'A' Map No. 58





-  Zoning
-  Natural Heritage
-  Parcel Fabric



ZONING BY-LAW
SCHEDULE 'A'
Map No. 59



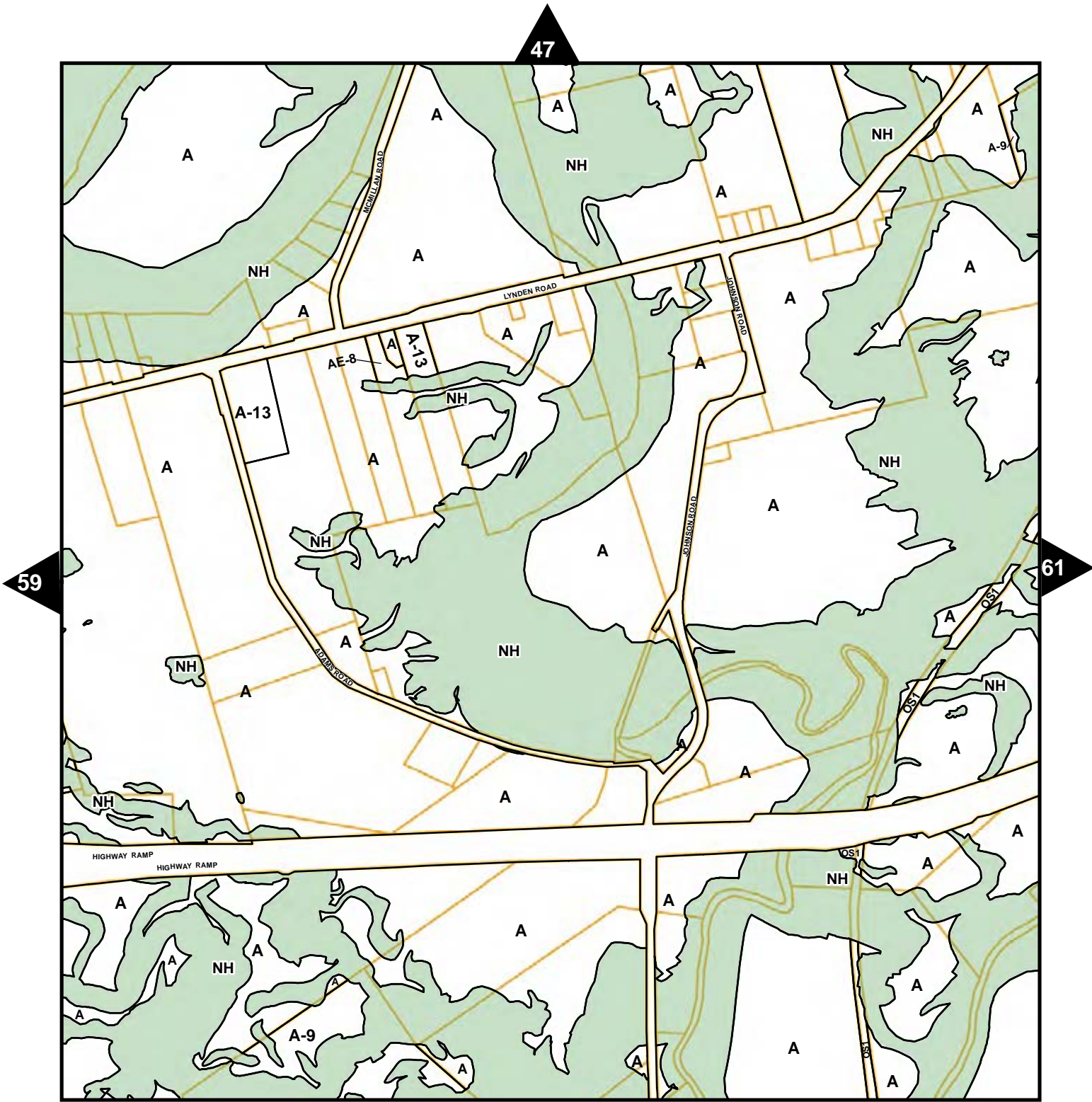

- Zoning
- Natural Heritage
- Parcel Fabric



ZONING BY-LAW SCHEDULE 'A' Map No. 60

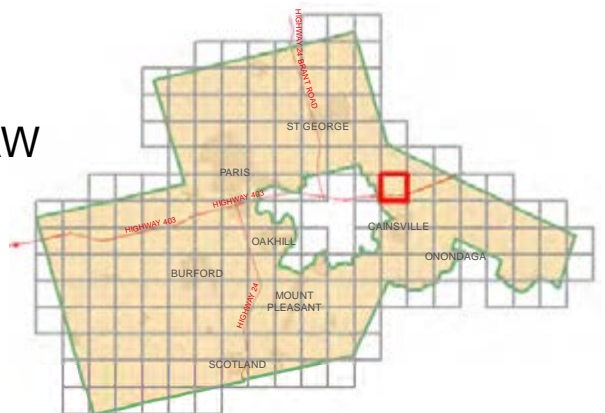

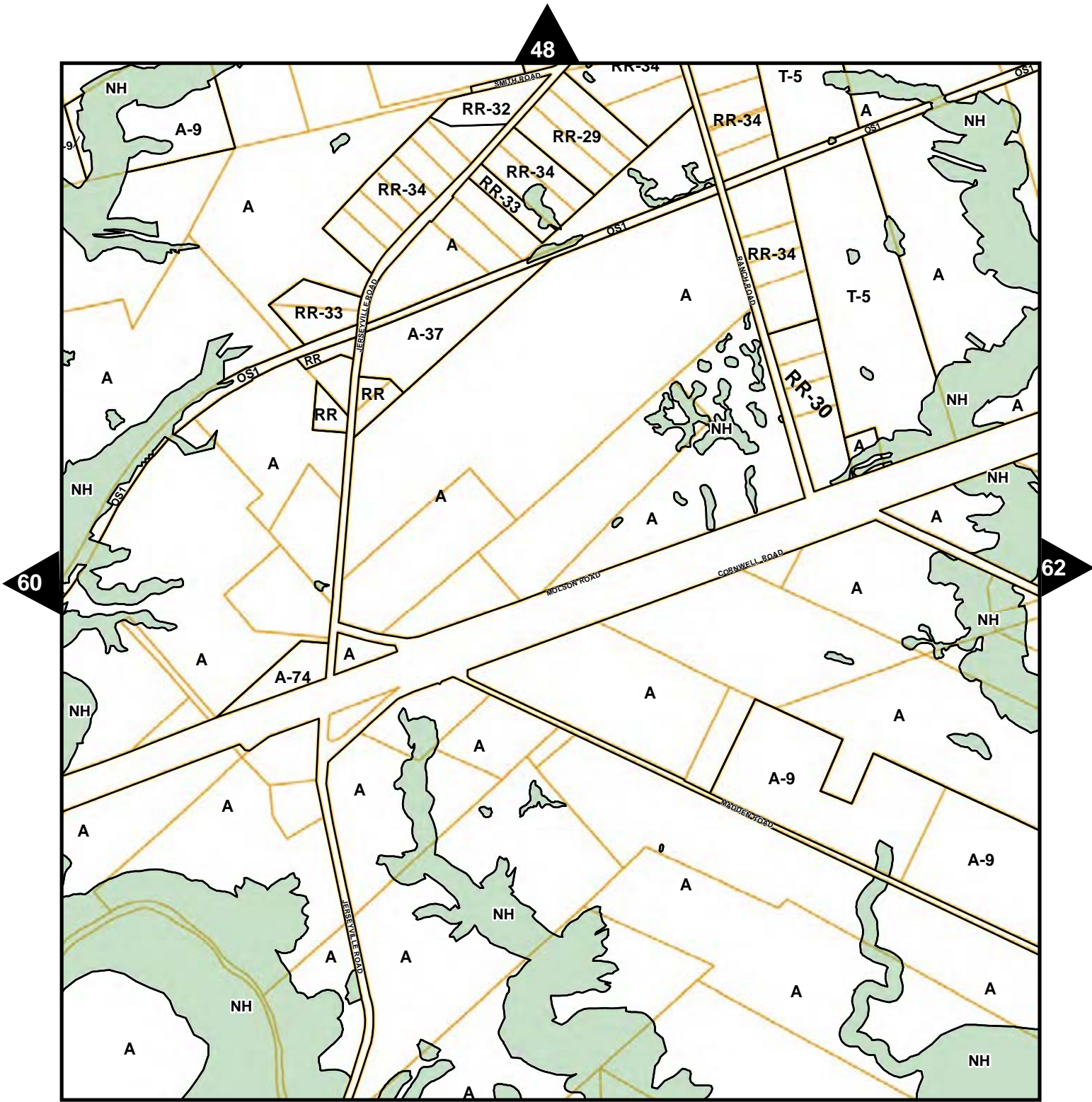

- Zoning
- Natural Heritage
- Parcel Fabric

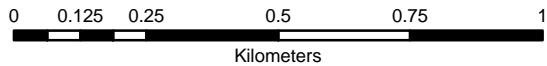

ZONING BY-LAW
SCHEDULE 'A'
Map No. 61

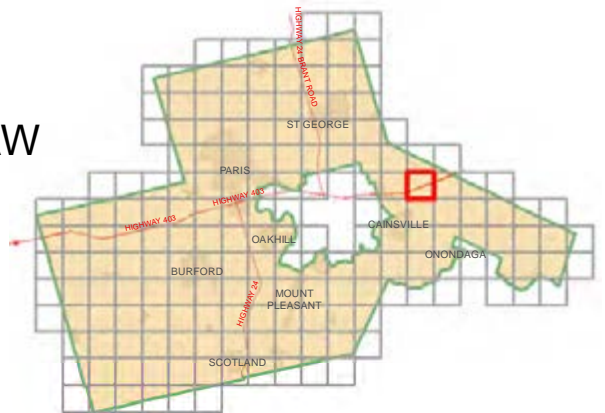

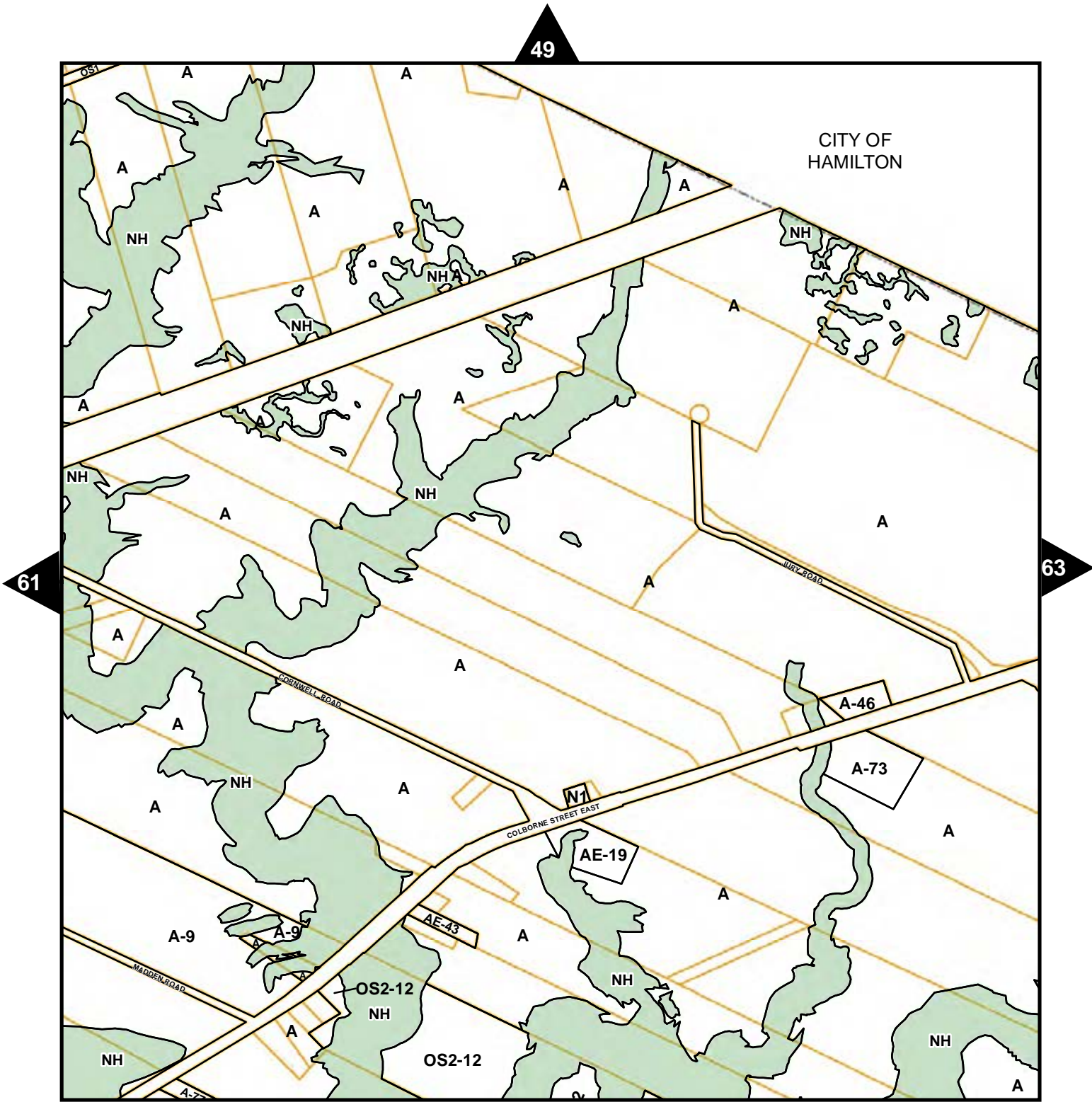

- Zoning
- Natural Heritage
- Parcel Fabric

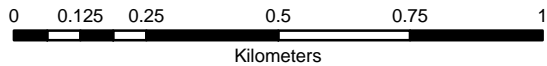

ZONING BY-LAW
SCHEDULE 'A'
Map No. 62



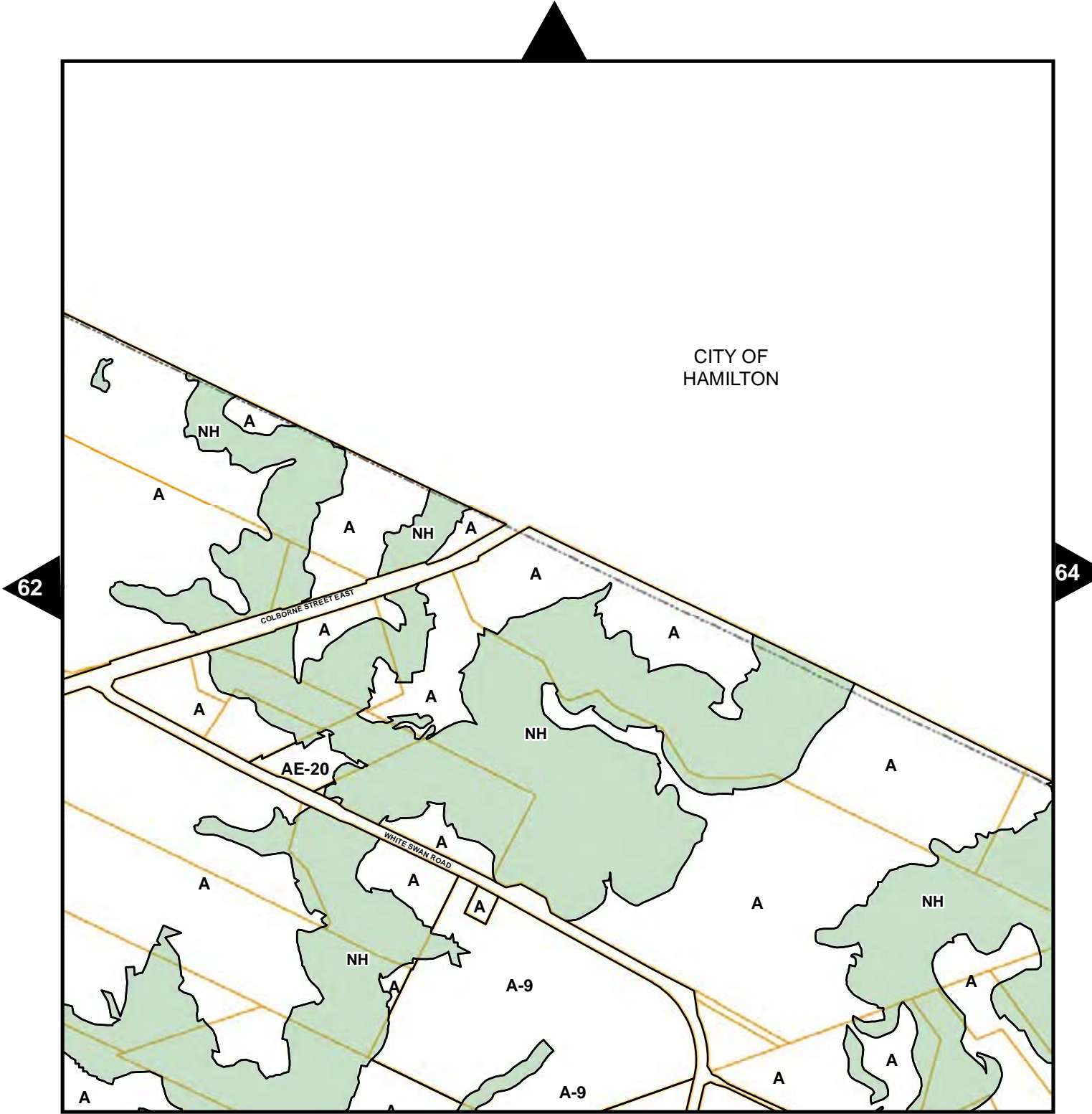

- Zoning
- Natural Heritage
- Parcel Fabric



ZONING BY-LAW SCHEDULE 'A' Map No. 63





CITY OF
HAMILTON

63

80



-  Zoning
-  Natural Heritage
-  Parcel Fabric

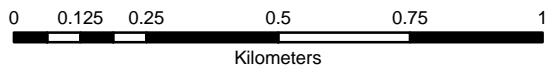

ZONING BY-LAW
SCHEDULE 'A'
Map No. 64



COUNTY OF OXFORD



- Zoning
- Natural Heritage
- Parcel Fabric

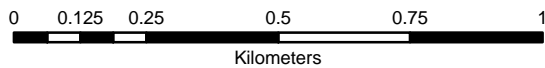

ZONING BY-LAW
SCHEDULE 'A'
Map No. 65

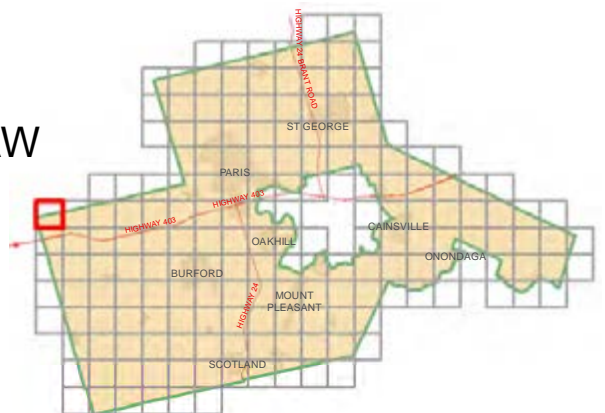

COUNTY OF
OXFORD



65

67

84



ZONING BY-LAW
SCHEDULE 'A'
Map No. 66

-  Zoning
-  Natural Heritage
-  Parcel Fabric

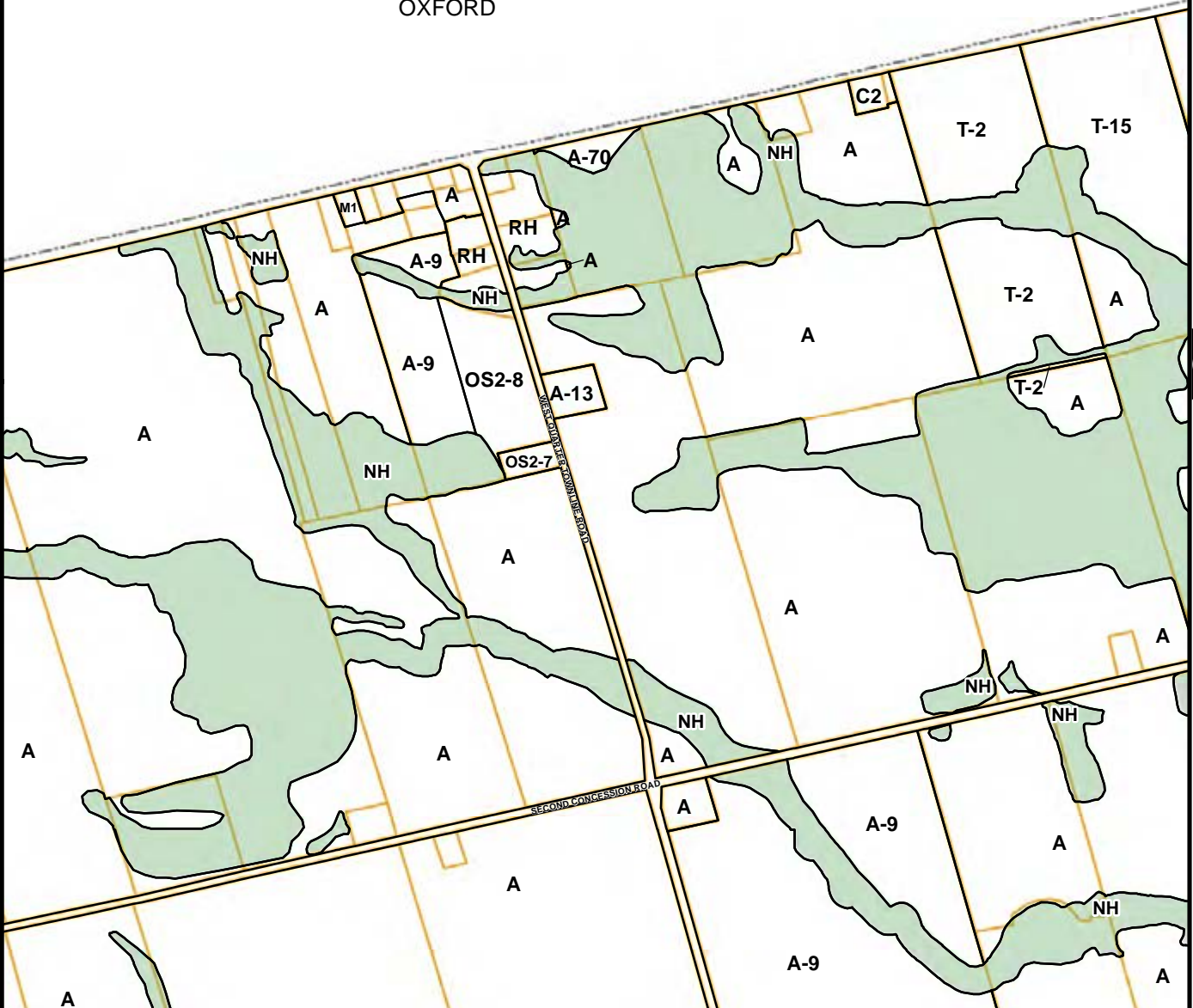
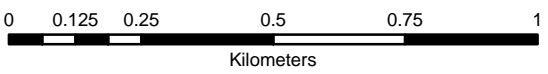

50

COUNTY OF OXFORD

C6-2

T-1-11

MIDDLE TOWNLINE ROAD

SECOND CONCESSION ROAD

A-68

AE-

66

68

85



ZONING BY-LAW SCHEDULE 'A' Map No. 67

- Zoning
- Natural Heritage
- Parcel Fabric

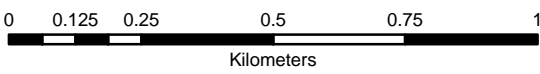

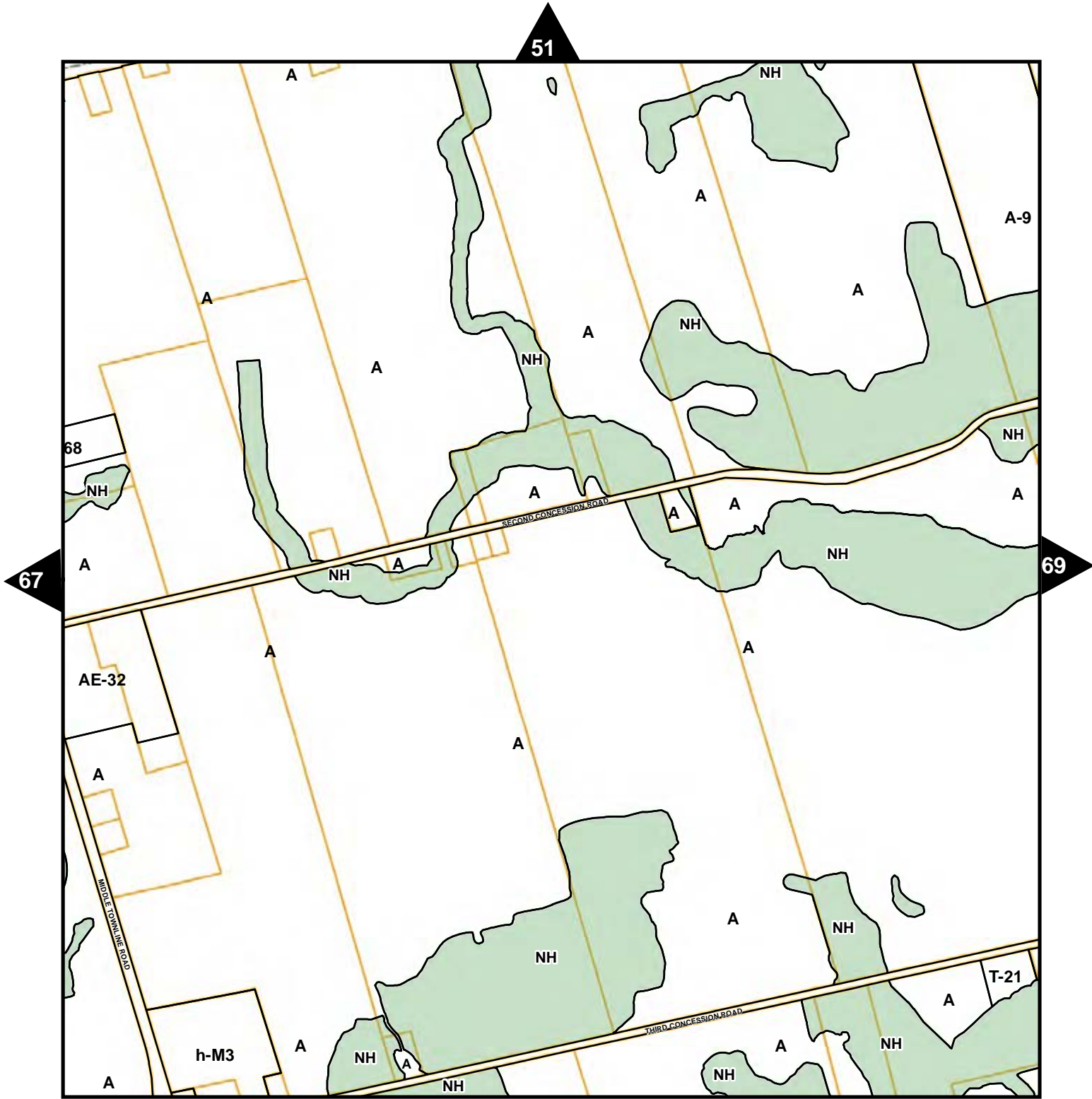

- Zoning
- Natural Heritage
- Parcel Fabric



ZONING BY-LAW SCHEDULE 'A' Map No. 68



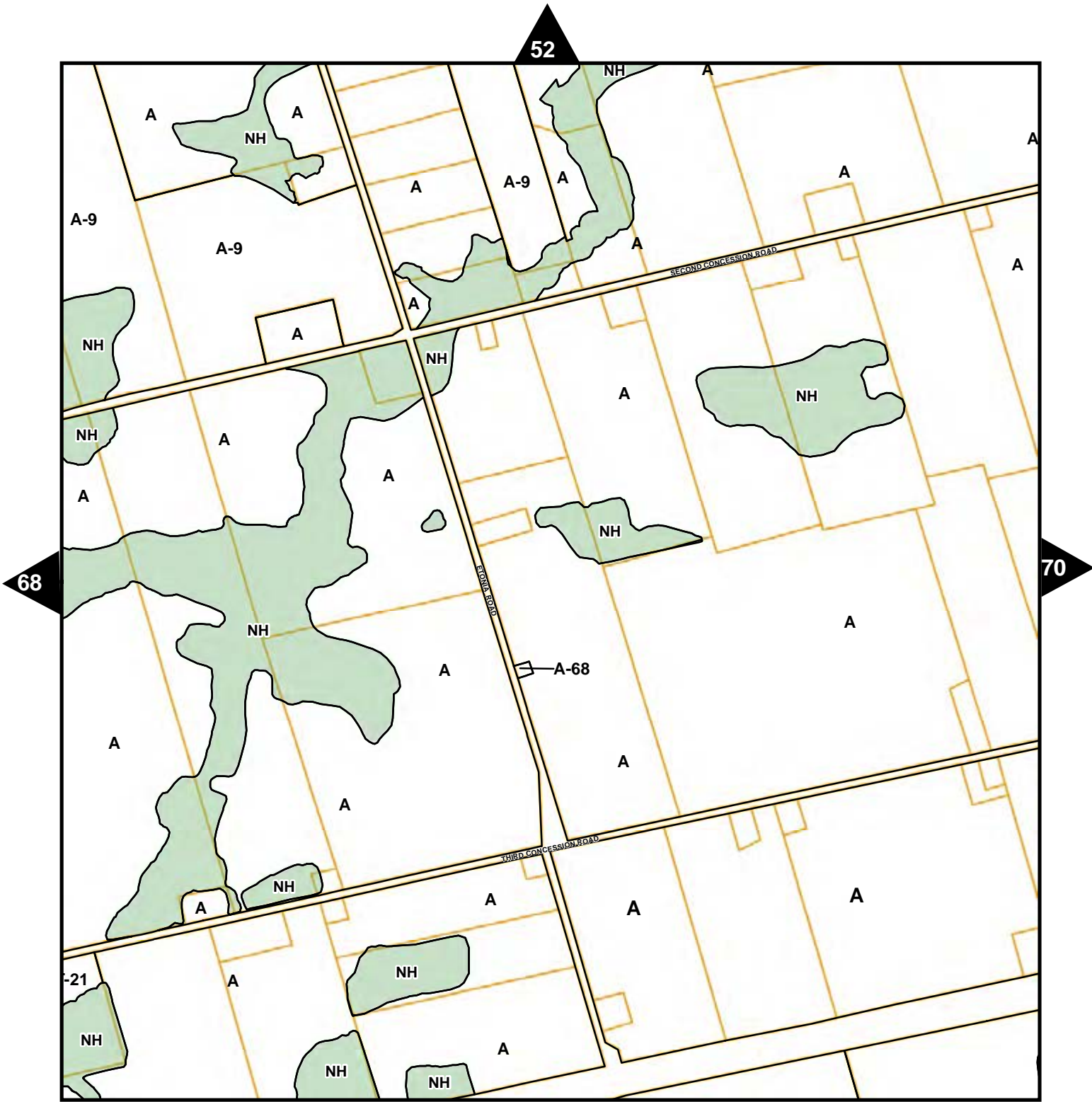



87



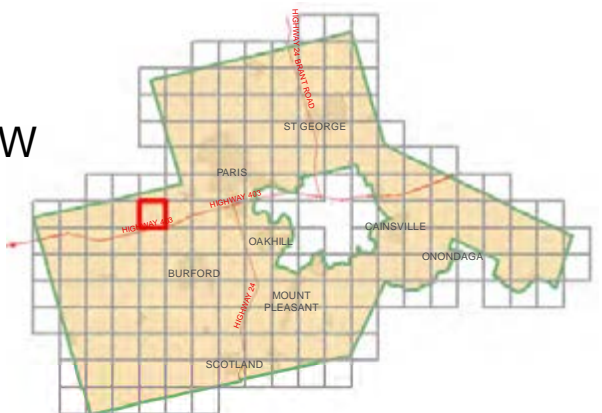
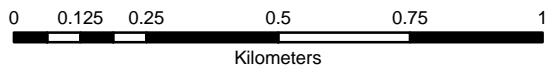

ZONING BY-LAW
SCHEDULE 'A'
Map No. 69

-  Zoning
-  Natural Heritage
-  Parcel Fabric

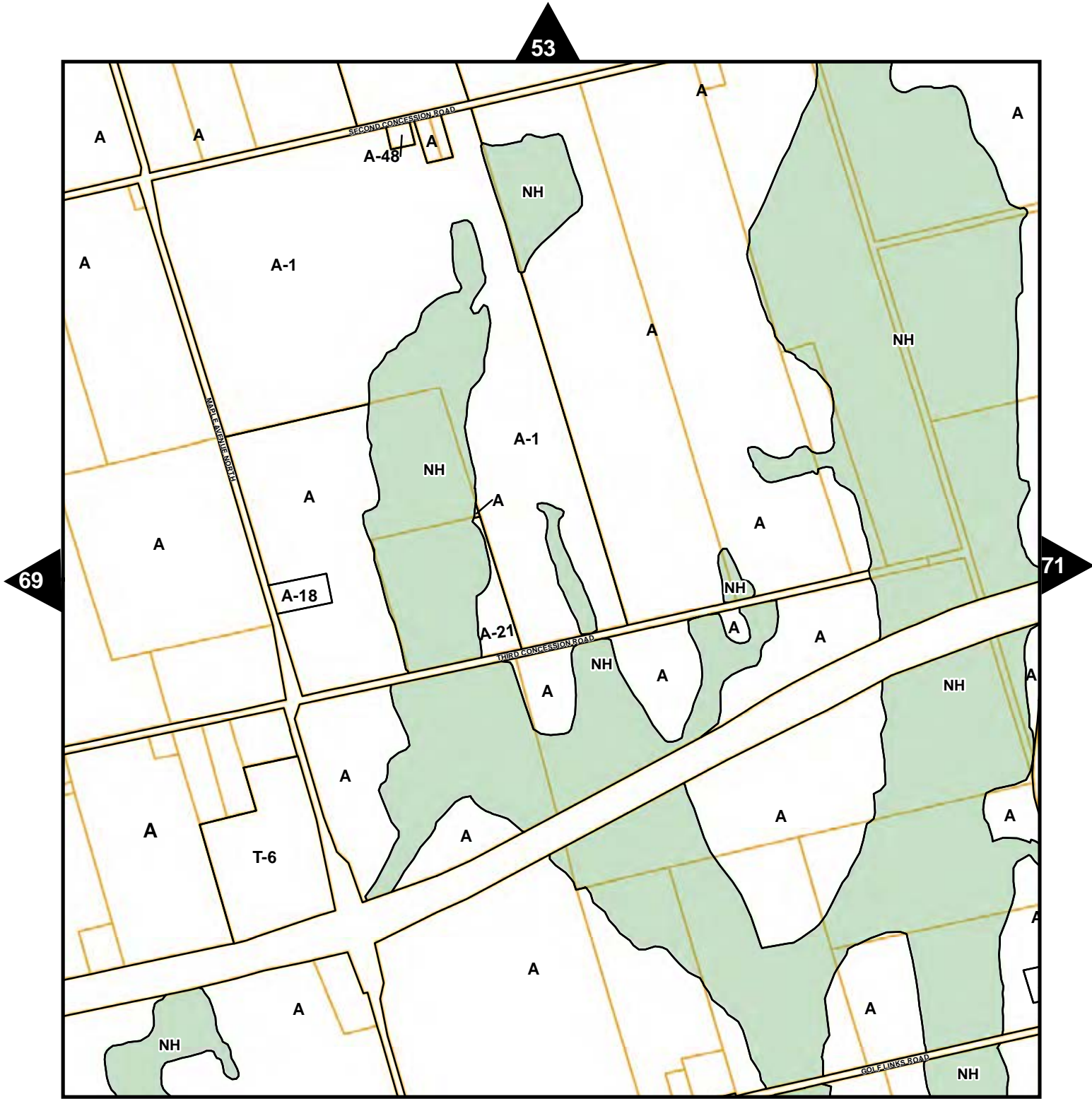



-  Zoning
-  Natural Heritage
-  Parcel Fabric



ZONING BY-LAW SCHEDULE 'A' Map No. 70

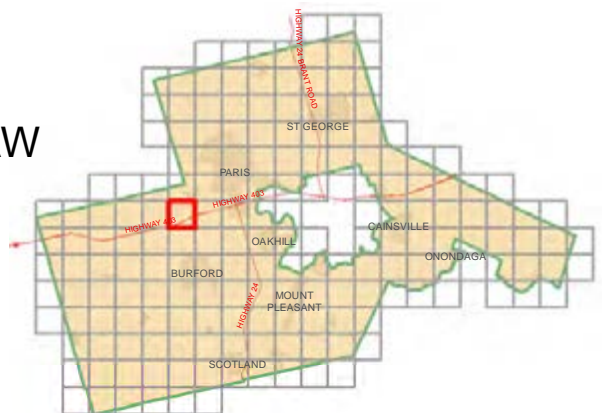

54

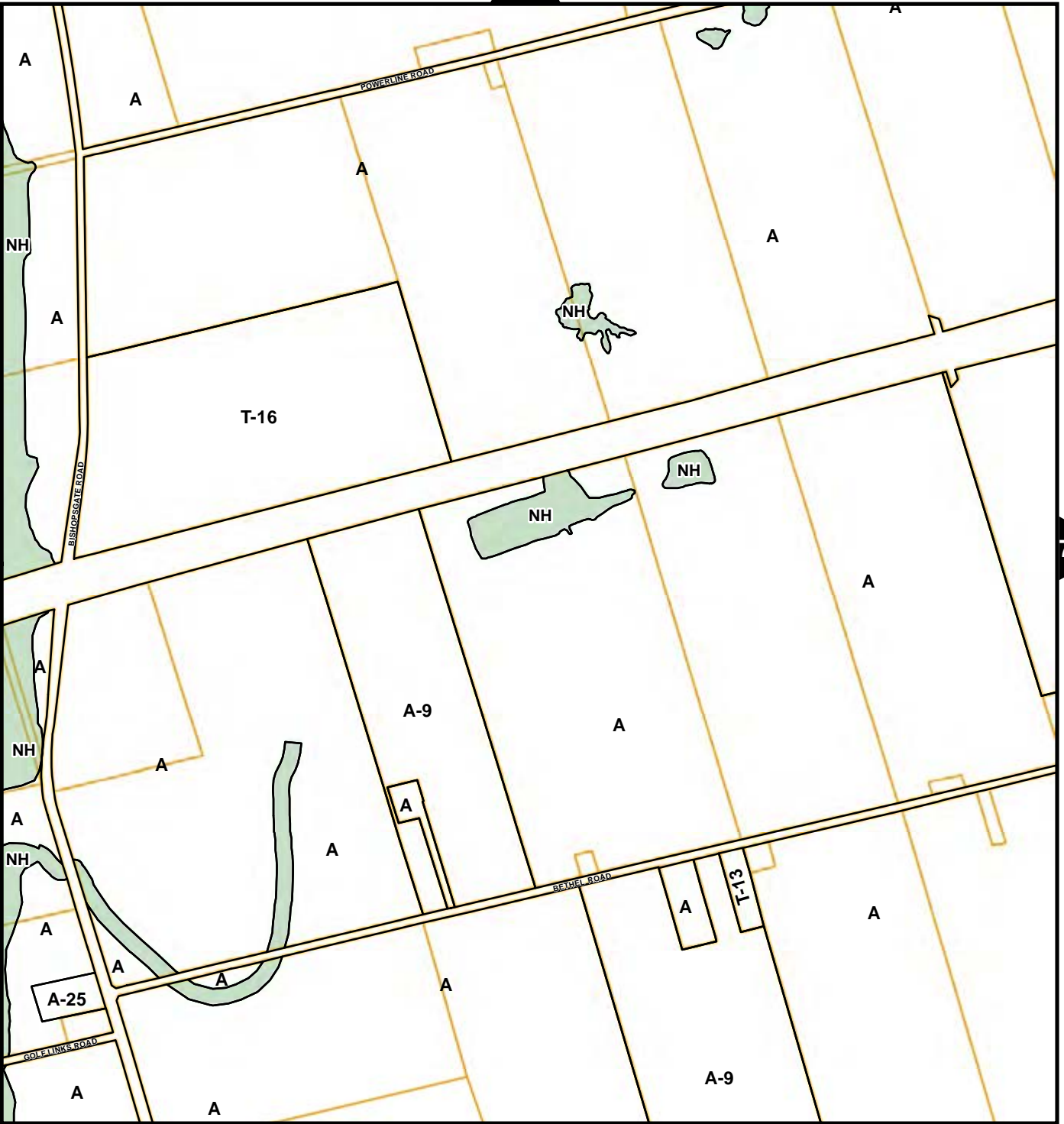

89



- Zoning
- Natural Heritage
- Parcel Fabric

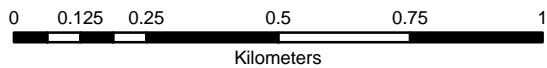

ZONING BY-LAW SCHEDULE 'A' Map No. 71





- Zoning
- Natural Heritage
- Parcel Fabric

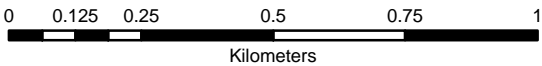

ZONING BY-LAW SCHEDULE 'A' Map No. 72



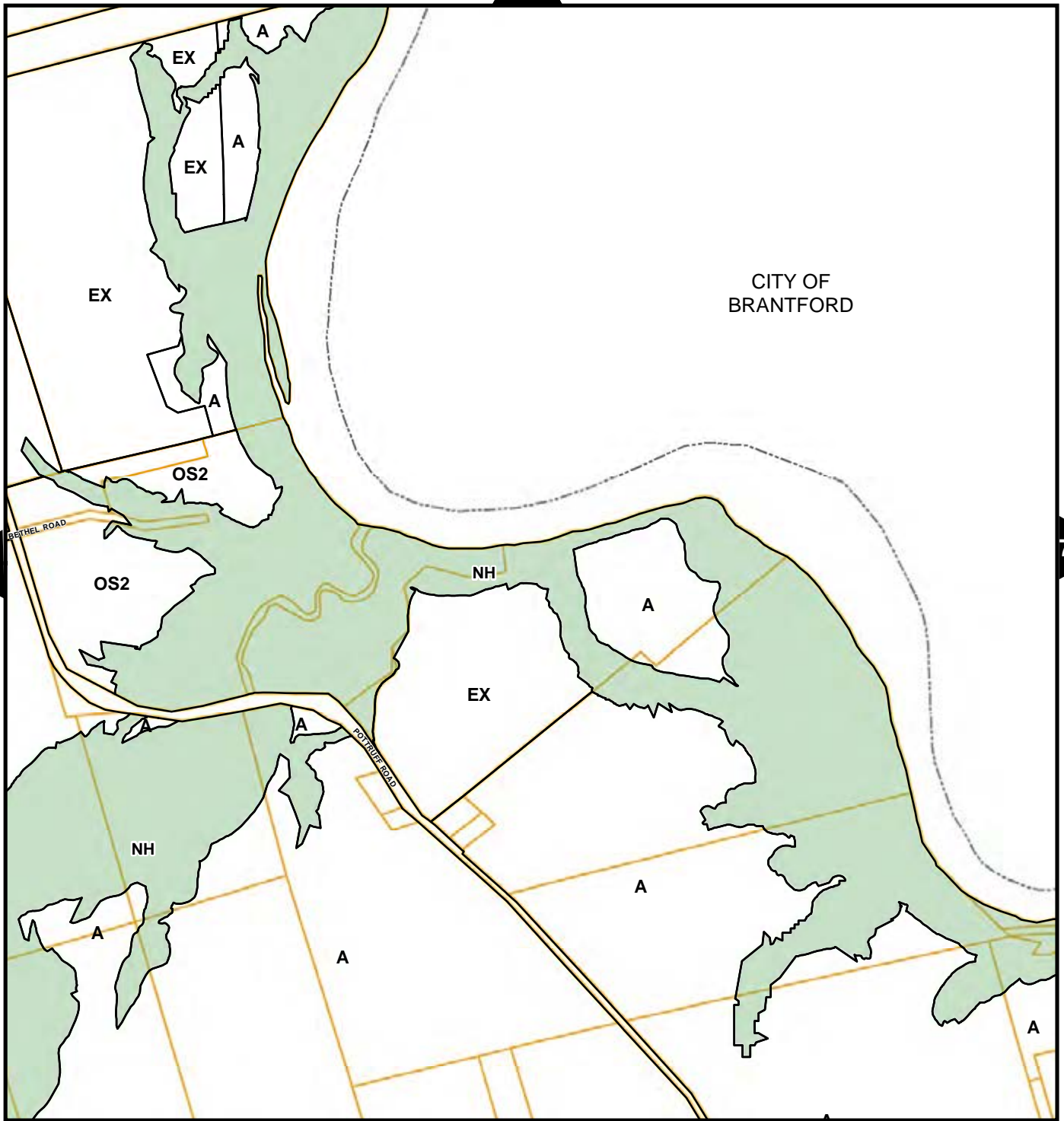

56



91



-  Zoning
-  Natural Heritage
-  Parcel Fabric

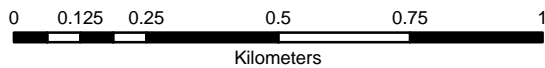



ZONING BY-LAW
SCHEDULE 'A'
Map No. 73

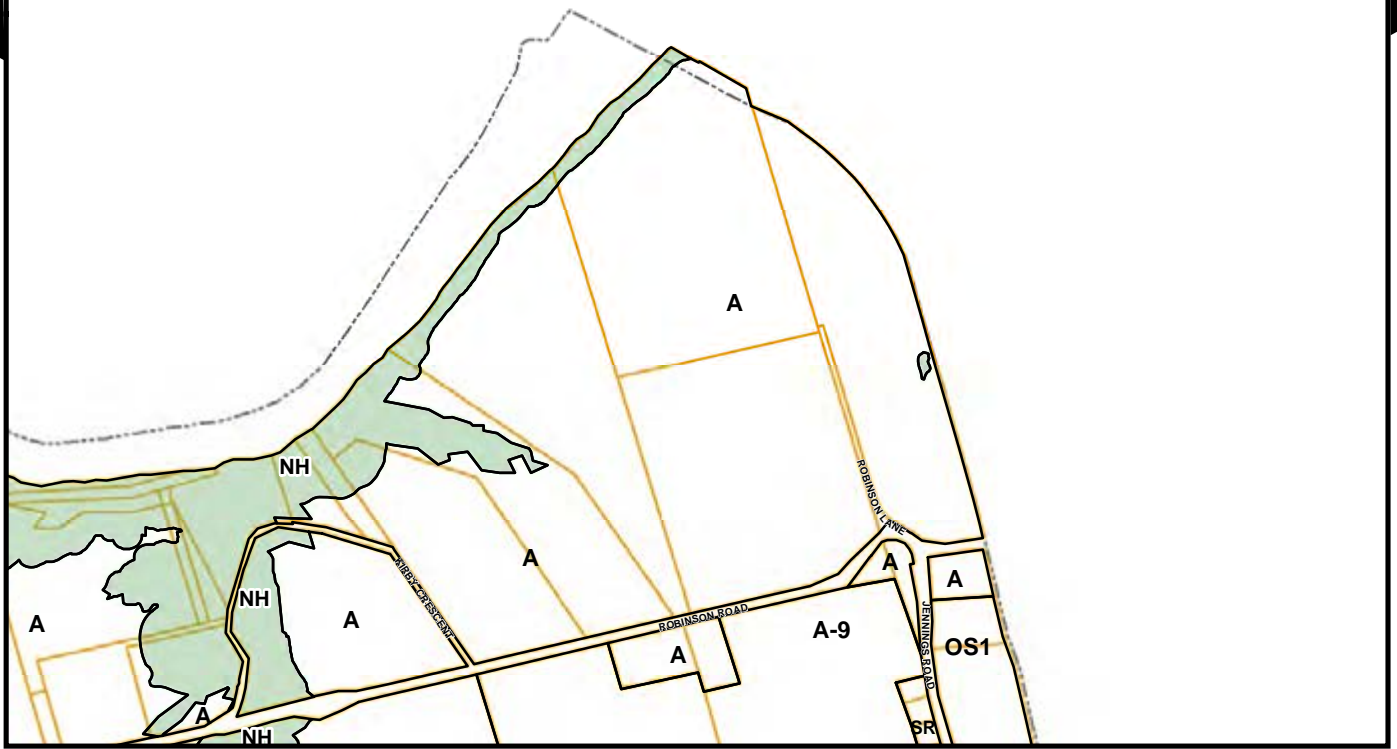

CITY OF BRANTFORD



-  Zoning
-  Natural Heritage
-  Parcel Fabric

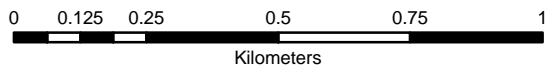

ZONING BY-LAW
SCHEDULE 'A'
Map No. 74



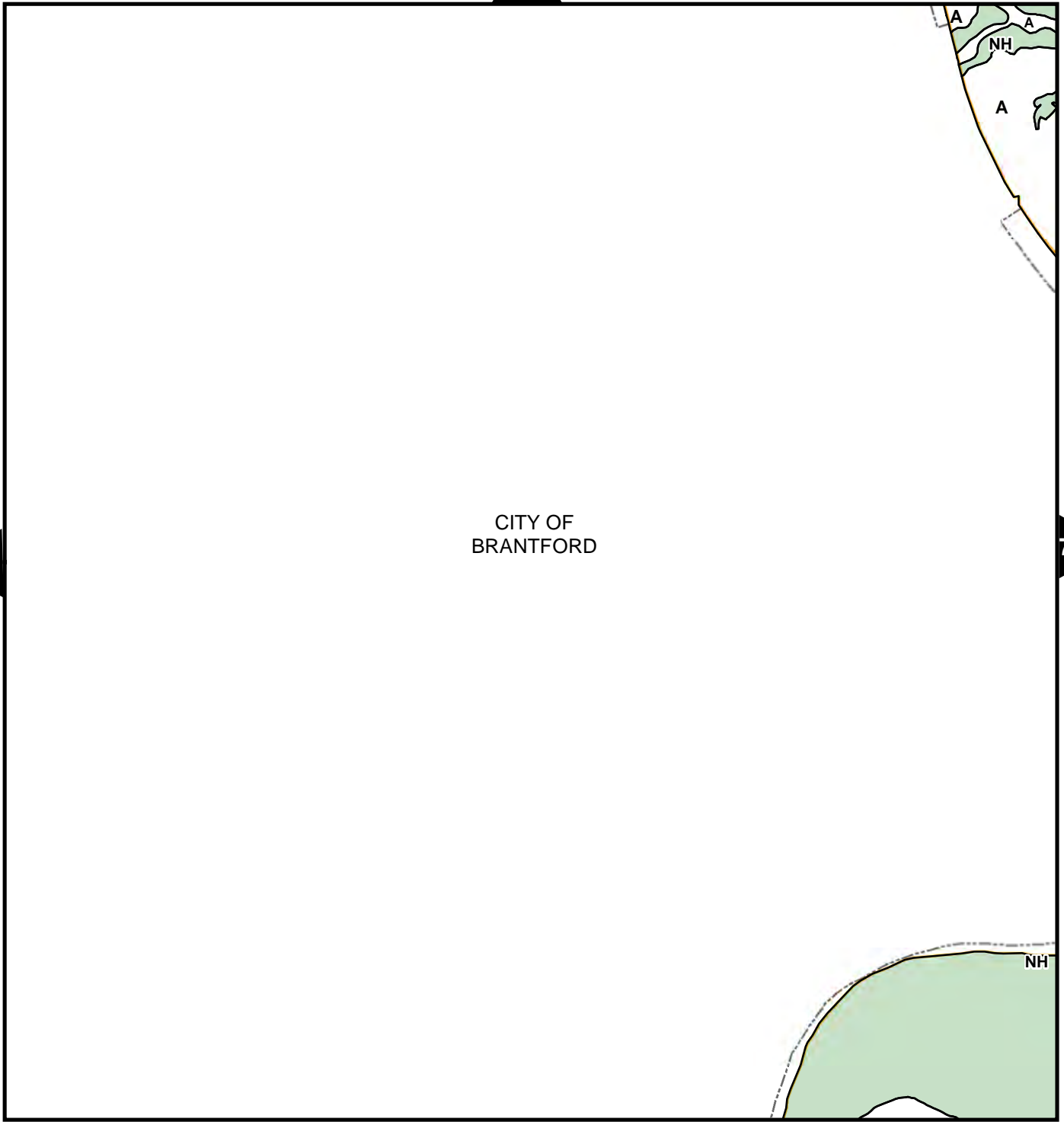

59



76

94



-  Zoning
-  Natural Heritage
-  Parcel Fabric

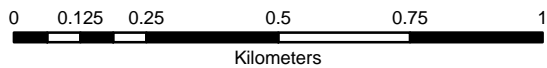

ZONING BY-LAW
SCHEDULE 'A'
Map No. 75



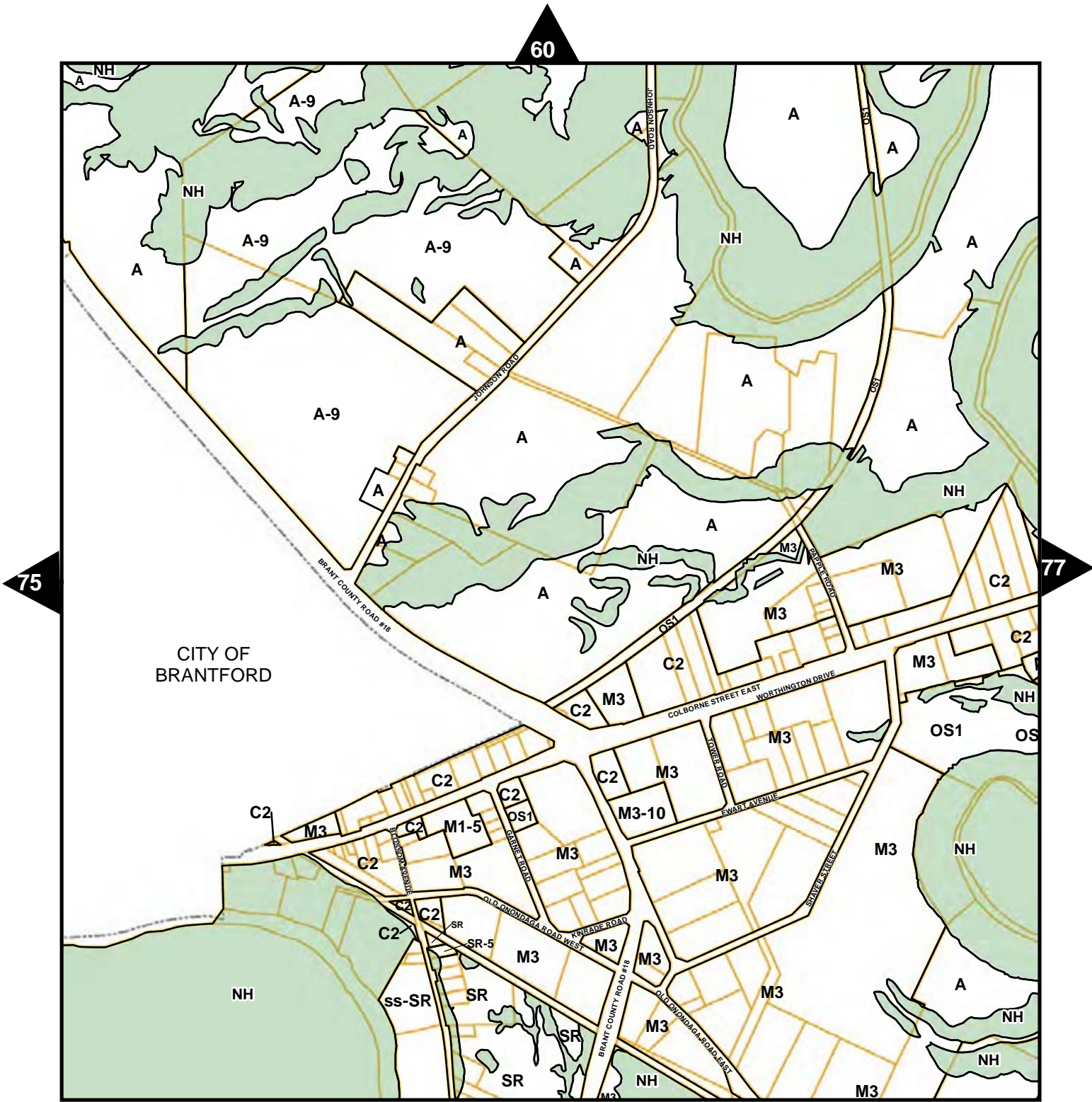

- Zoning
- Natural Heritage
- Parcel Fabric

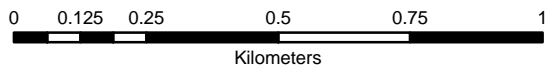

ZONING BY-LAW
SCHEDULE 'A'
Map No. 76



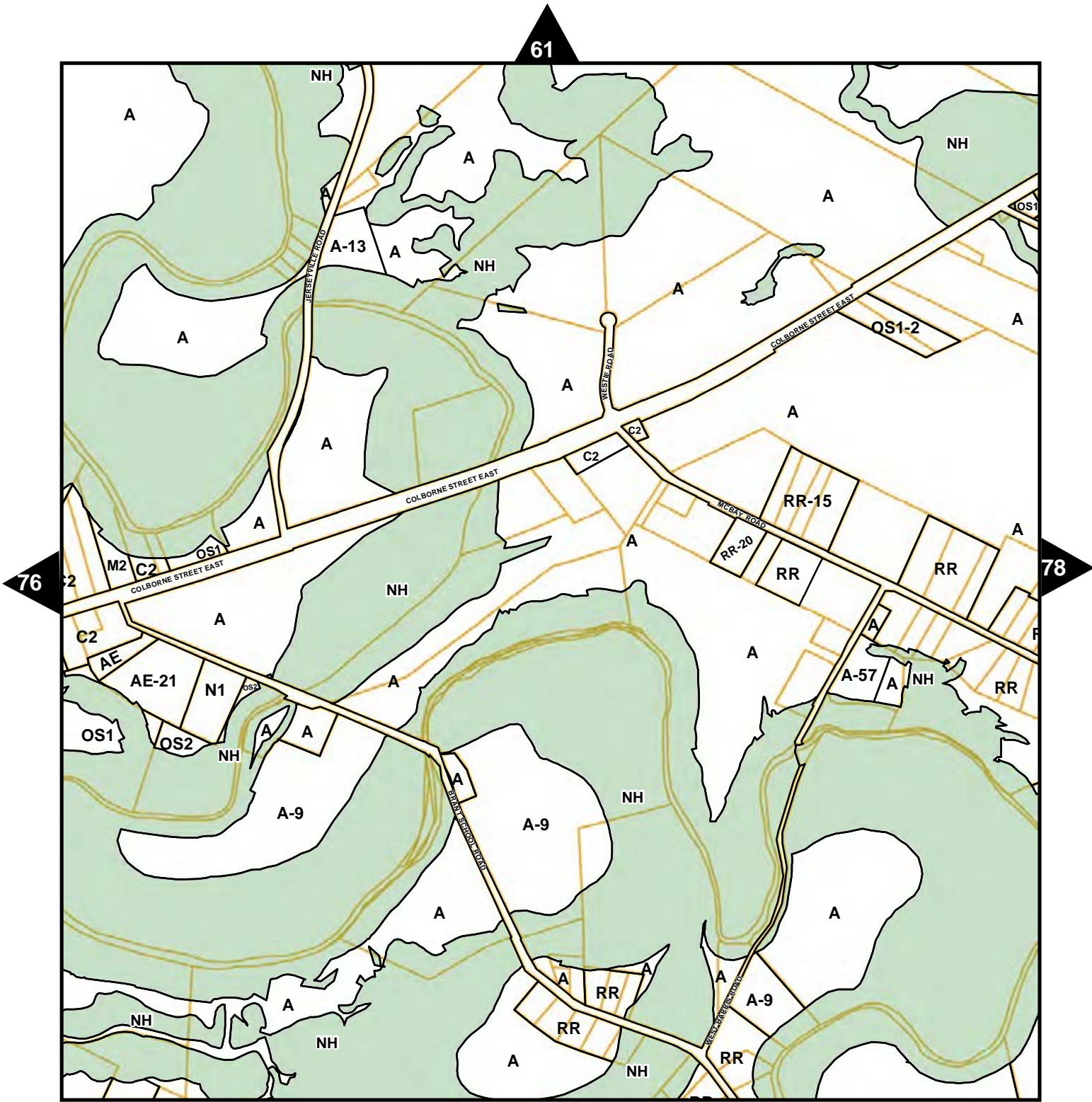

- Zoning
- Natural Heritage
- Parcel Fabric



ZONING BY-LAW SCHEDULE 'A' Map No. 77

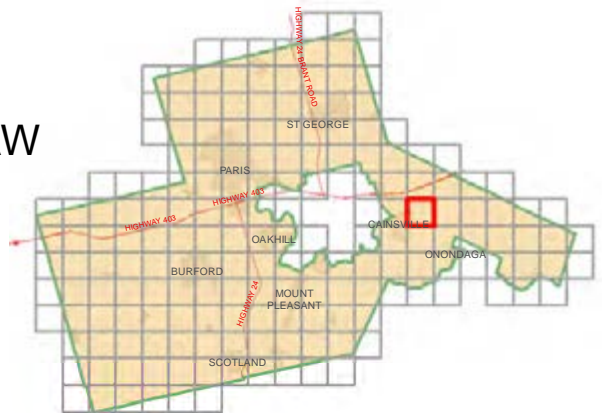

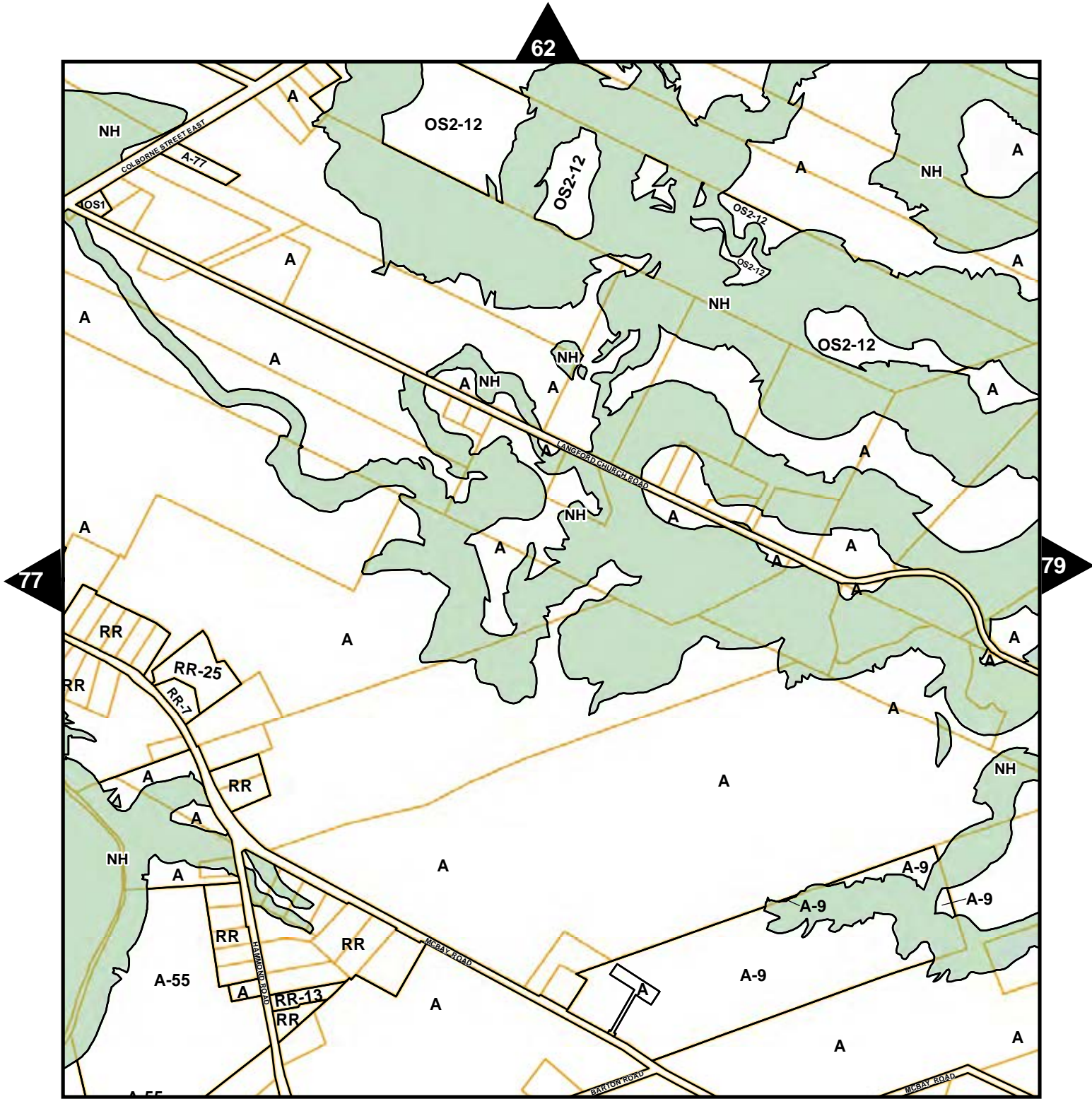





- Zoning
- Natural Heritage
- Parcel Fabric

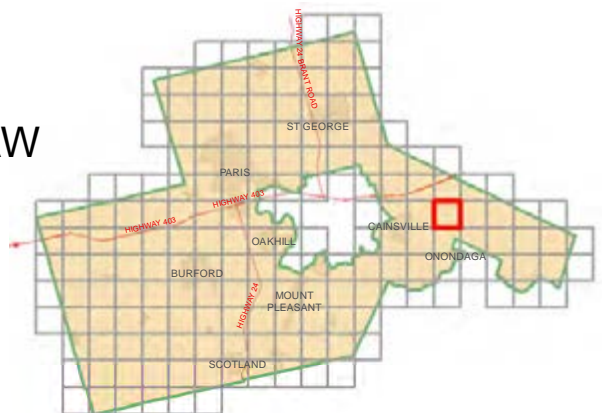

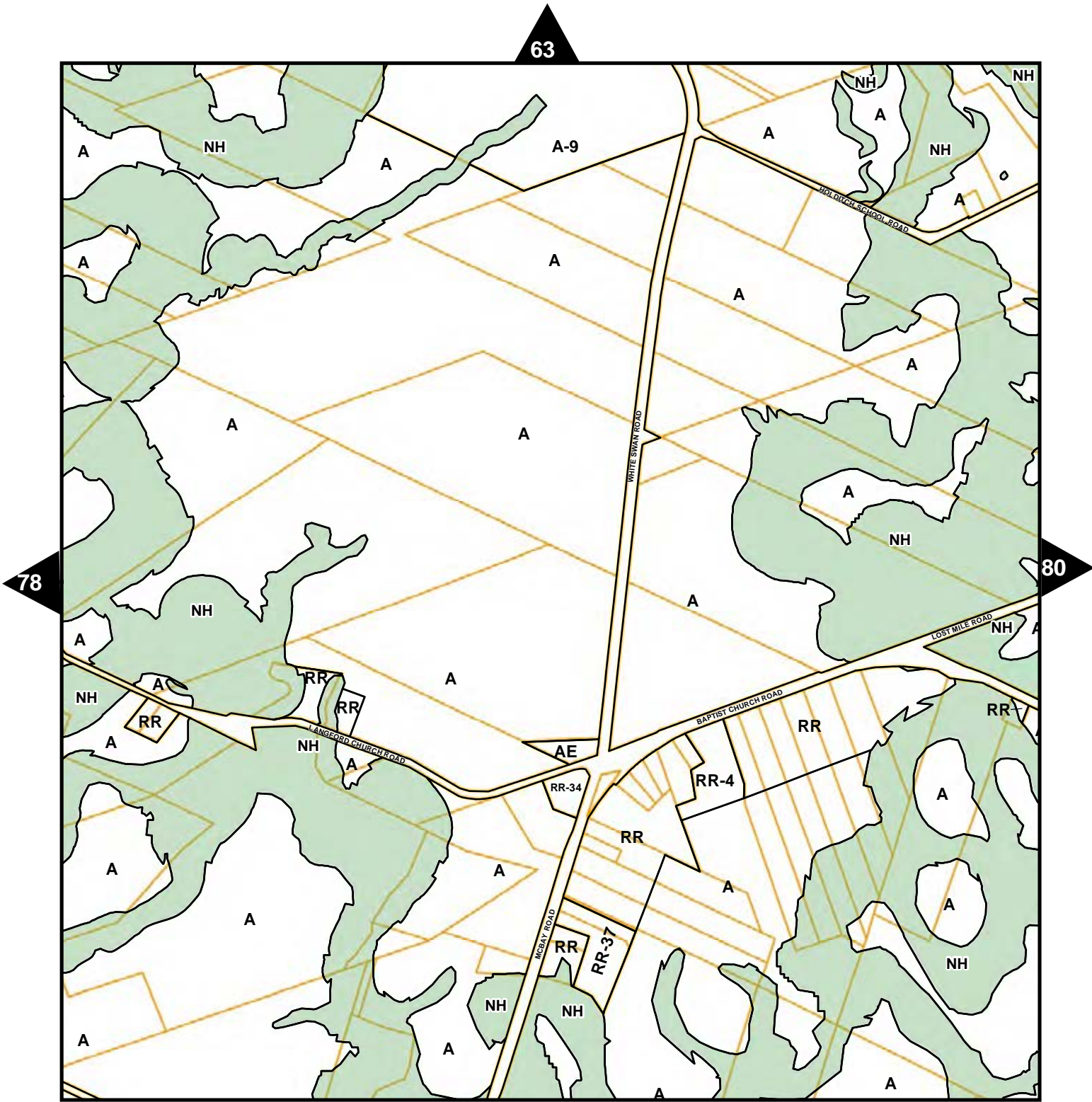
ZONING BY-LAW SCHEDULE 'A' Map No. 78





-  Zoning
-  Natural Heritage
-  Parcel Fabric

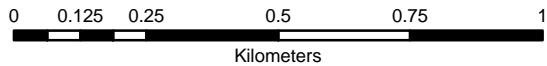

ZONING BY-LAW SCHEDULE 'A' Map No. 79

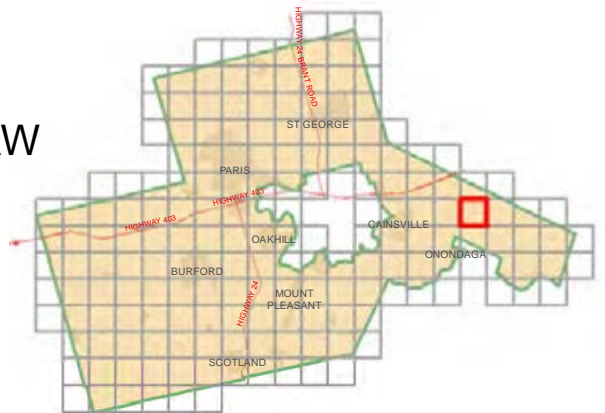

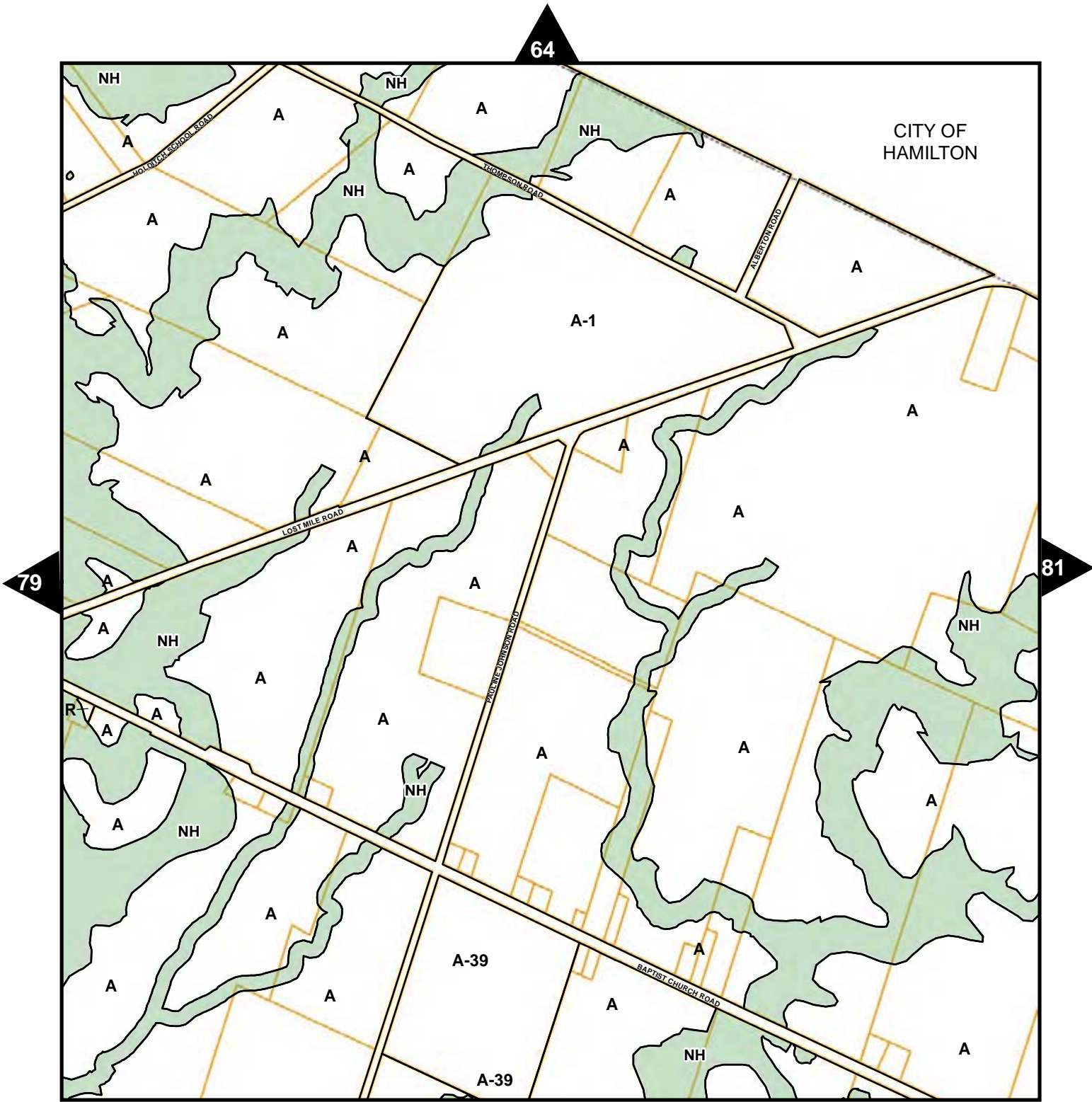





- Zoning
- Natural Heritage
- Parcel Fabric

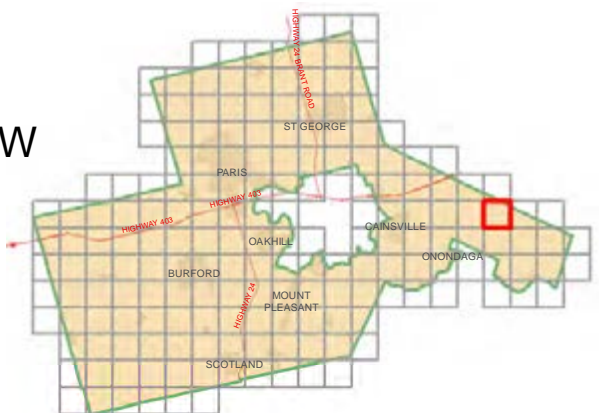

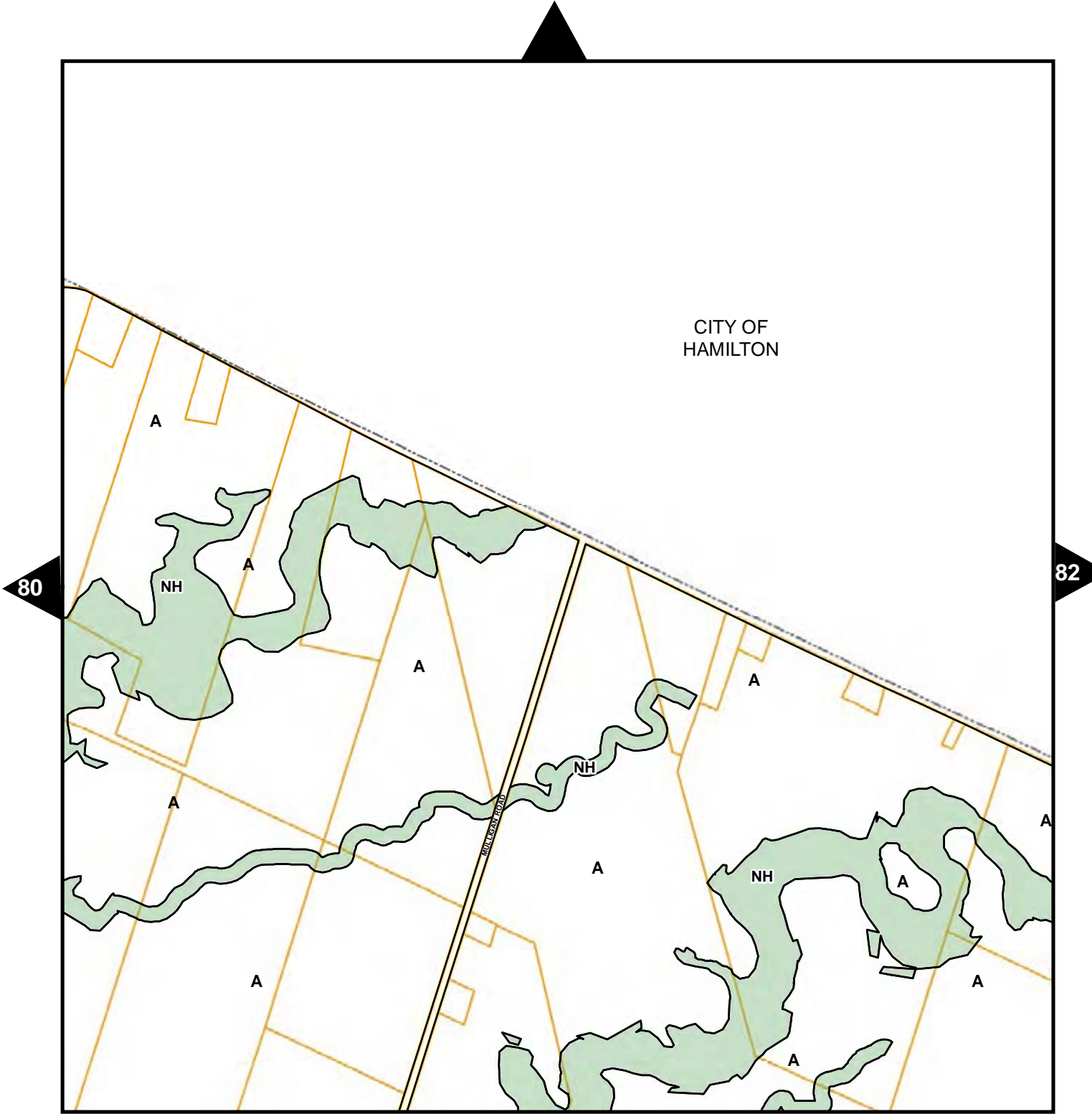
ZONING BY-LAW SCHEDULE 'A' Map No. 80





-  Zoning
-  Natural Heritage
-  Parcel Fabric



ZONING BY-LAW
SCHEDULE 'A'
Map No. 81

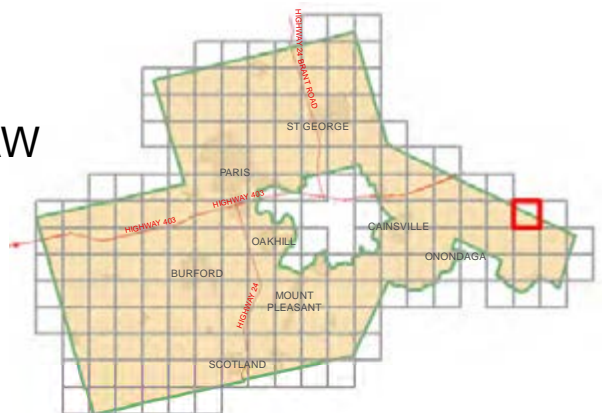



CITY OF HAMILTON

81

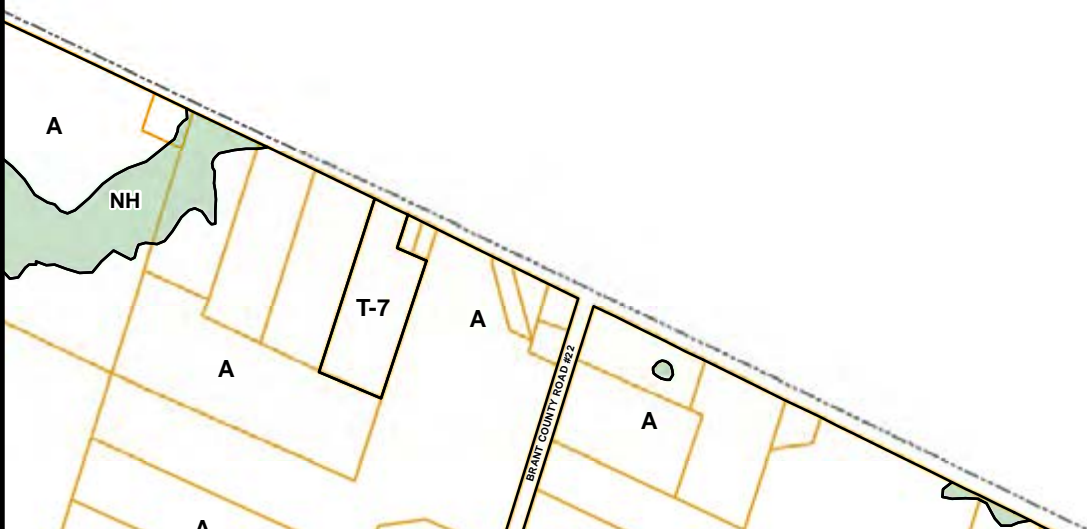
101



-  Zoning
-  Natural Heritage
-  Parcel Fabric

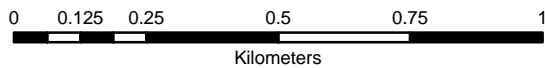

ZONING BY-LAW
SCHEDULE 'A'
Map No. 82



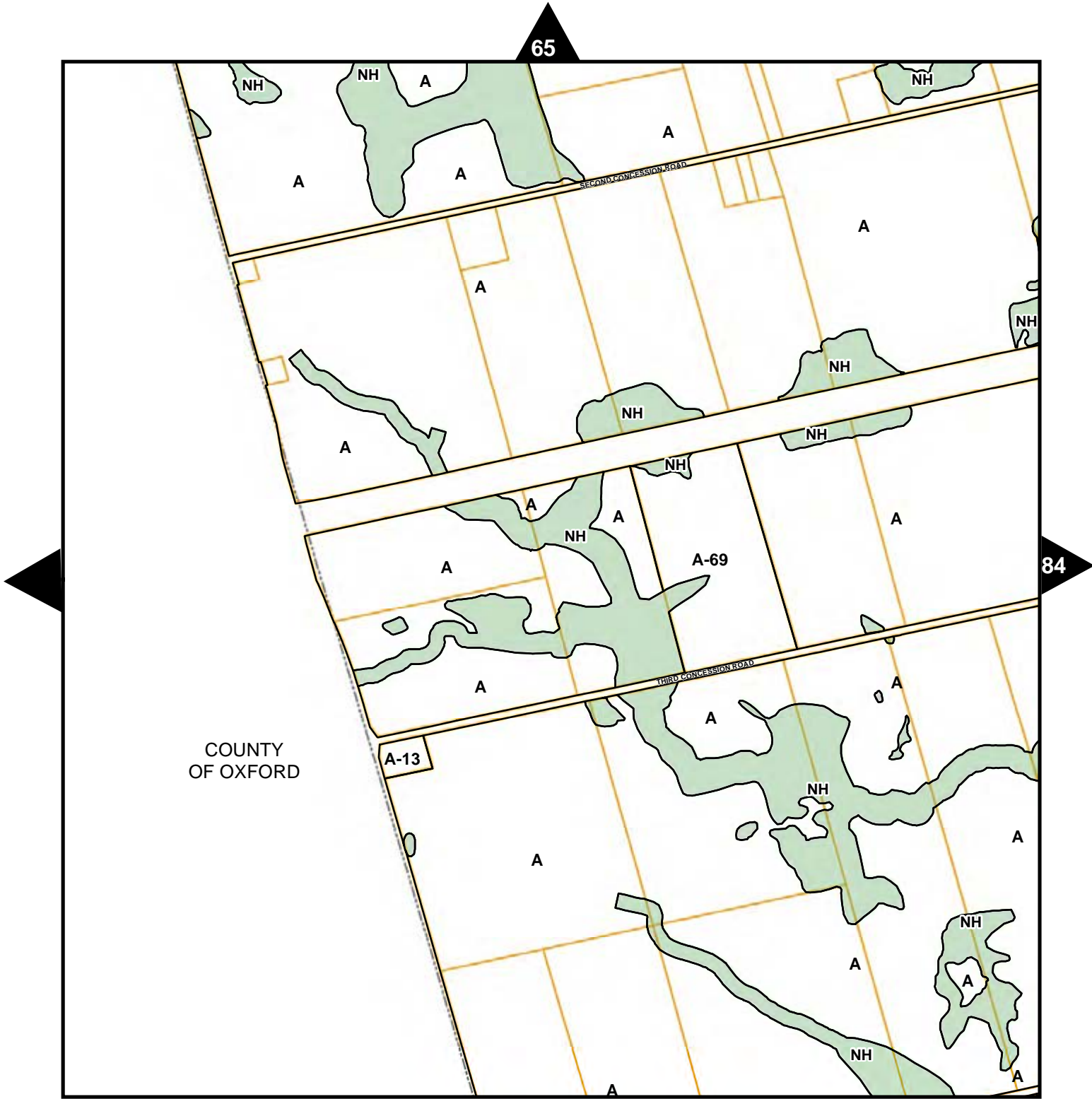

- Zoning
- Natural Heritage
- Parcel Fabric

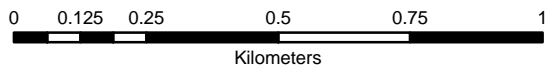

ZONING BY-LAW SCHEDULE 'A' Map No. 83

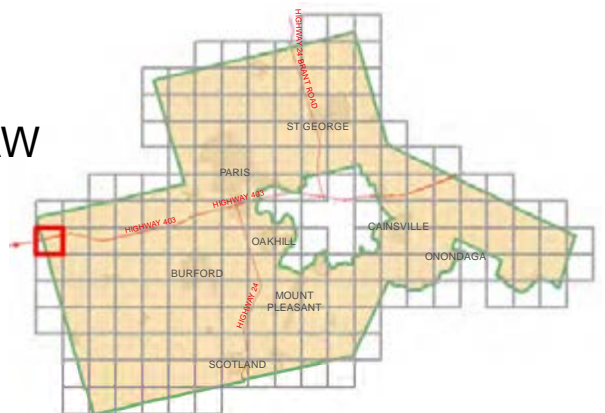

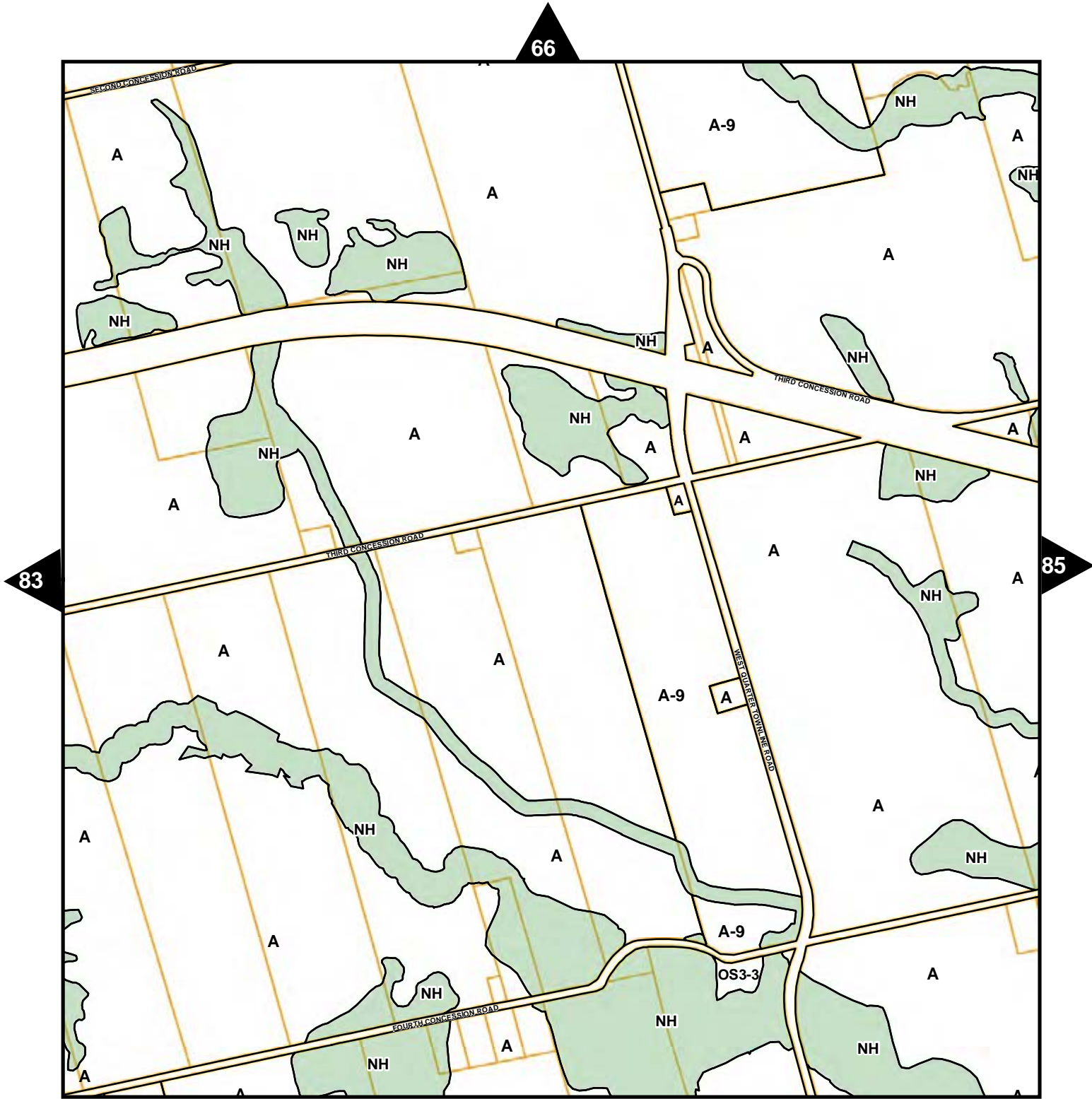

- Zoning
- Natural Heritage
- Parcel Fabric



ZONING BY-LAW SCHEDULE 'A' Map No. 84

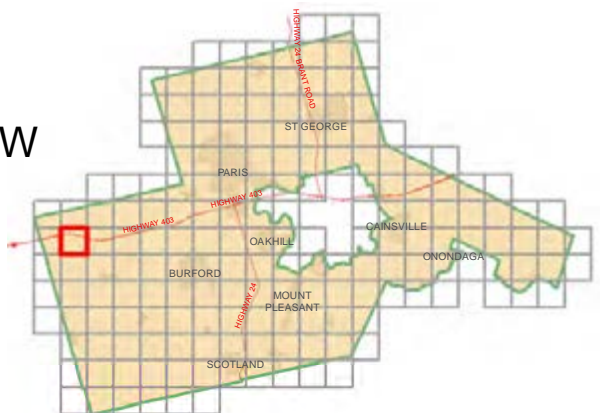

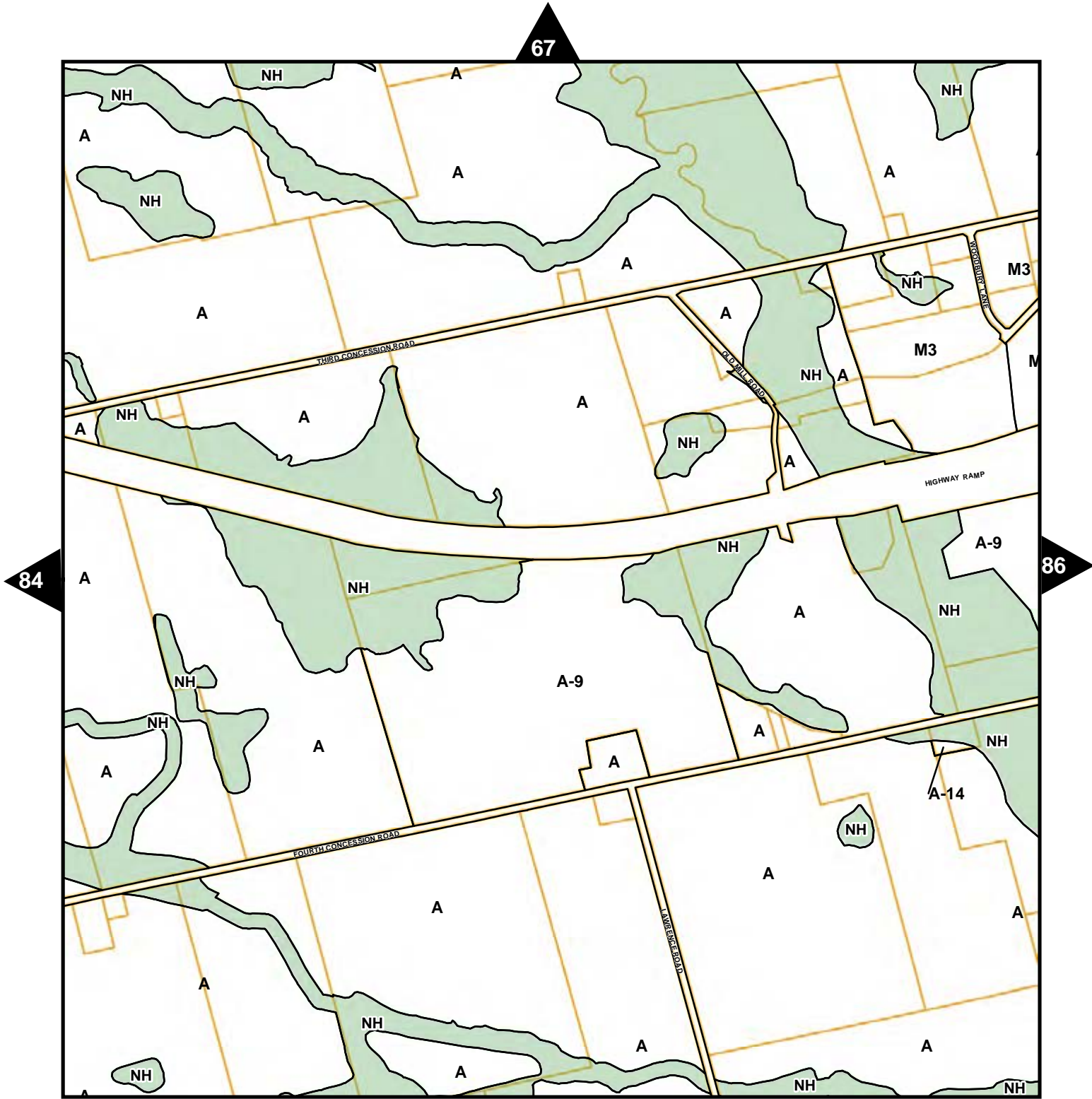

- Zoning
- Natural Heritage
- Parcel Fabric



ZONING BY-LAW SCHEDULE 'A' Map No. 85

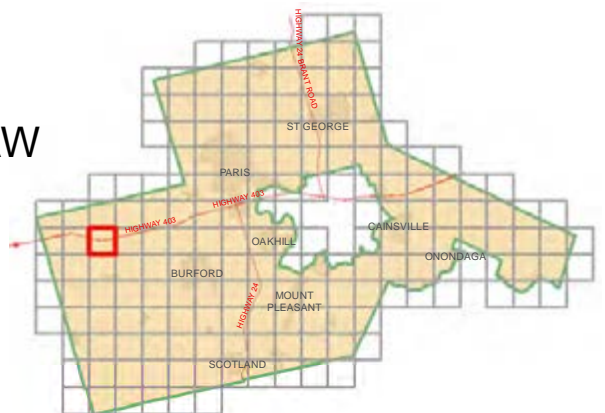

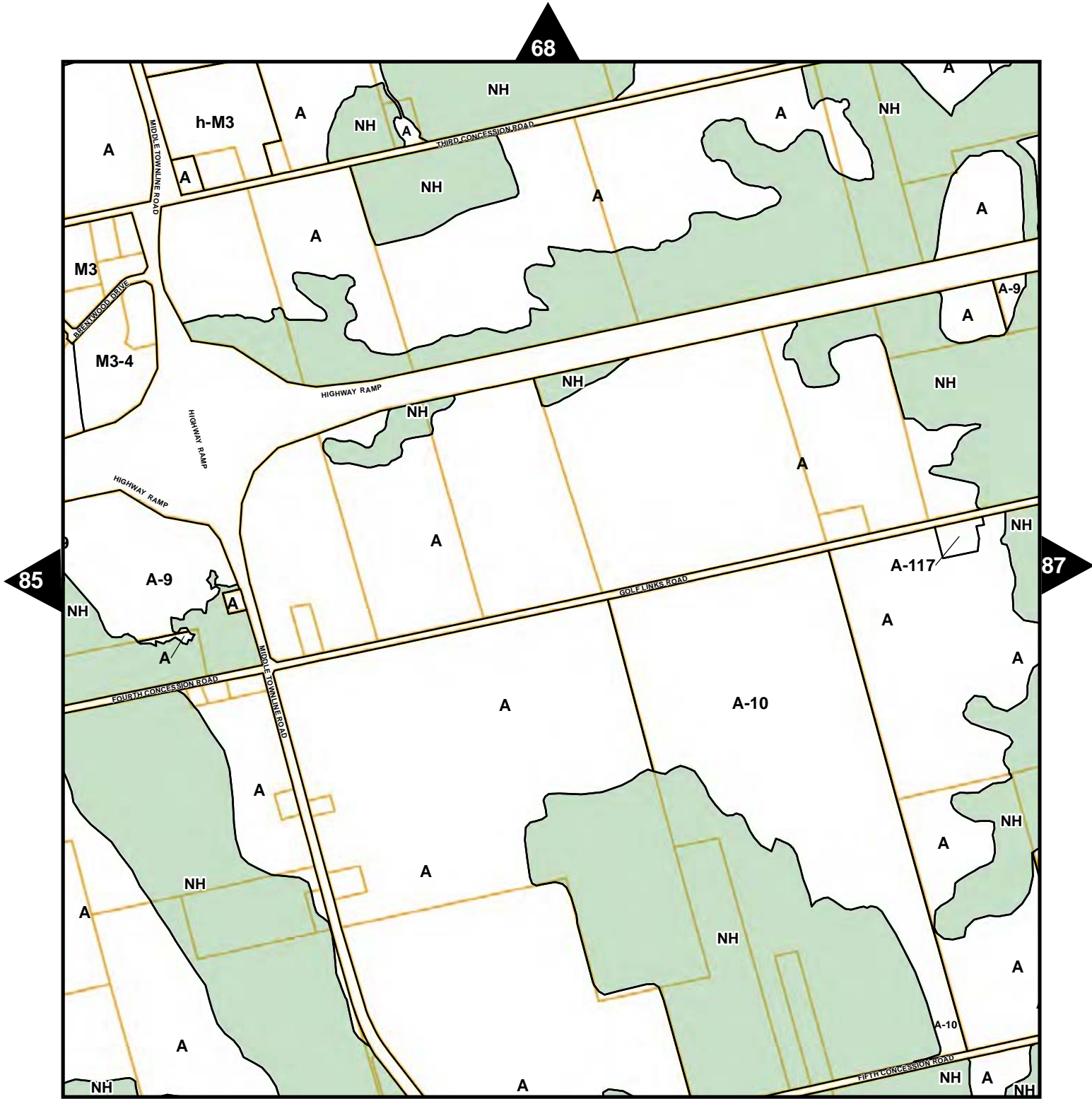

- Zoning
- Natural Heritage
- Parcel Fabric

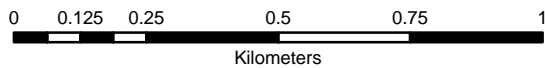

ZONING BY-LAW SCHEDULE 'A' Map No. 86



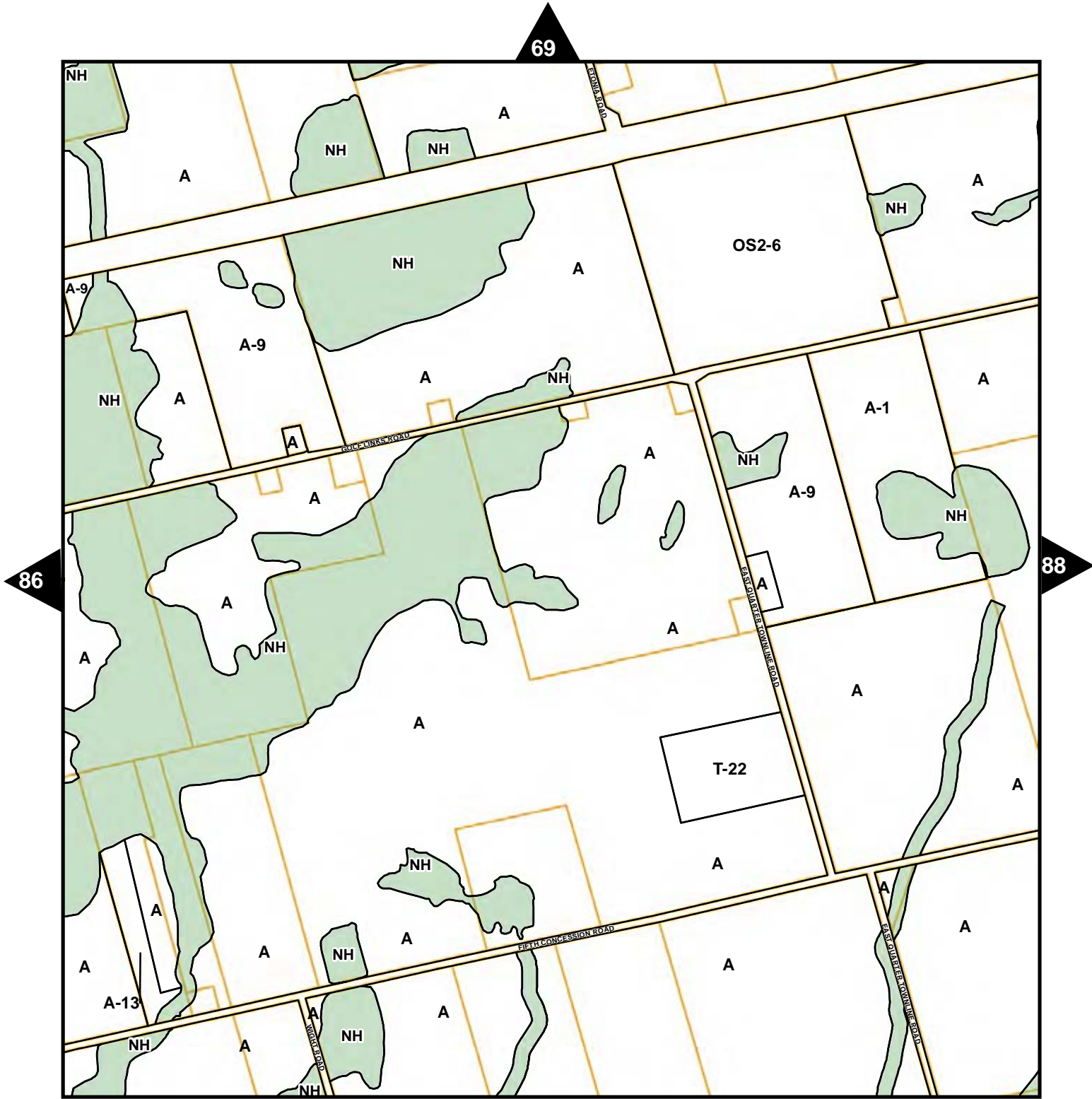





- Zoning
- Natural Heritage
- Parcel Fabric

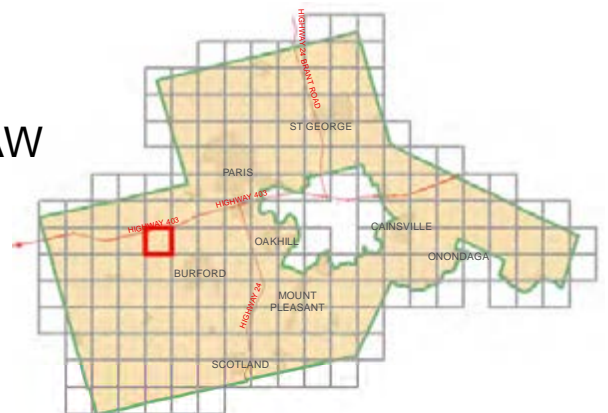

ZONING BY-LAW SCHEDULE 'A' Map No. 87





-  Zoning
-  Natural Heritage
-  Parcel Fabric



ZONING BY-LAW SCHEDULE 'A' Map No. 88



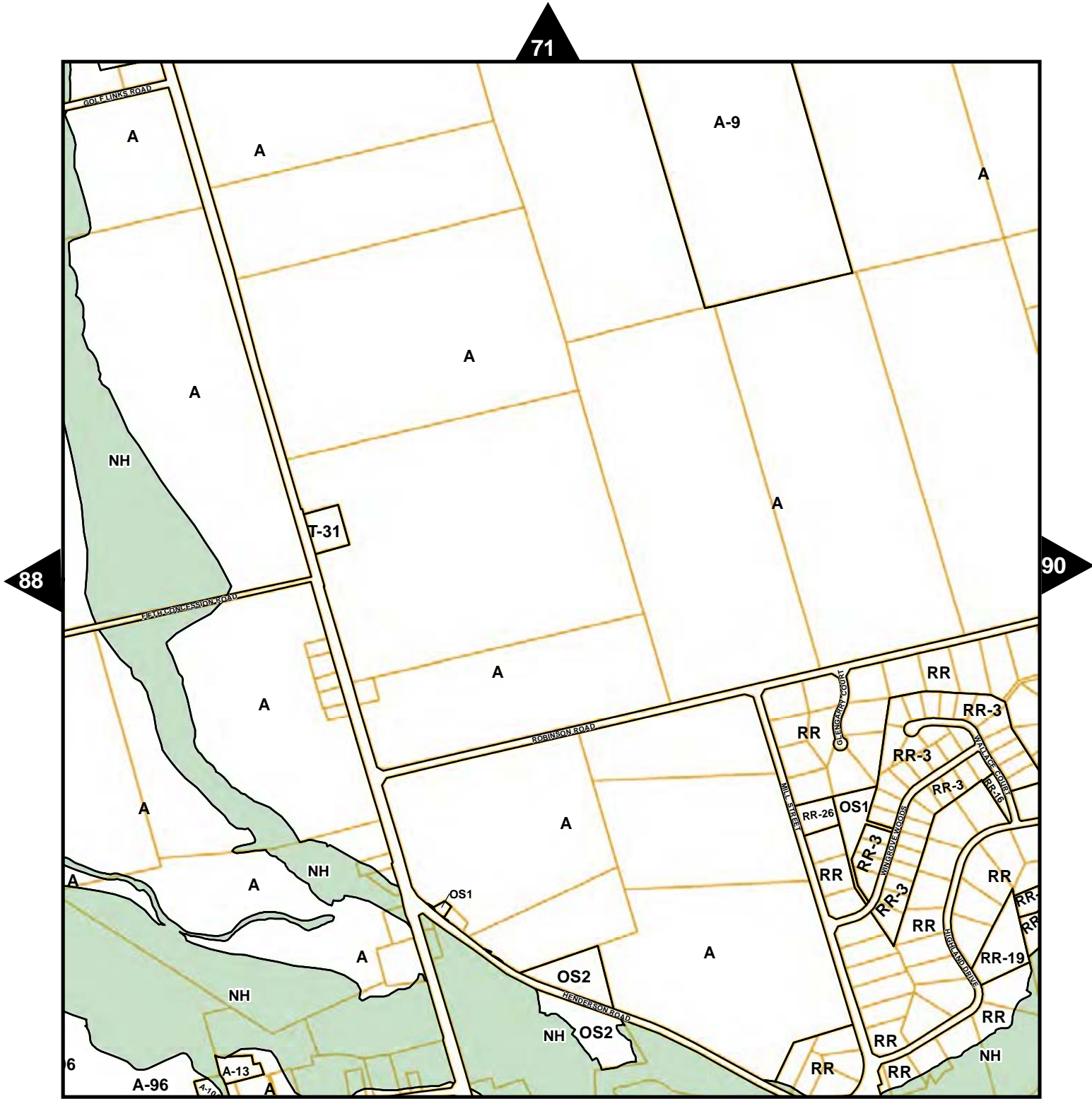

- Zoning
- Natural Heritage
- Parcel Fabric



ZONING BY-LAW SCHEDULE 'A' Map No. 89



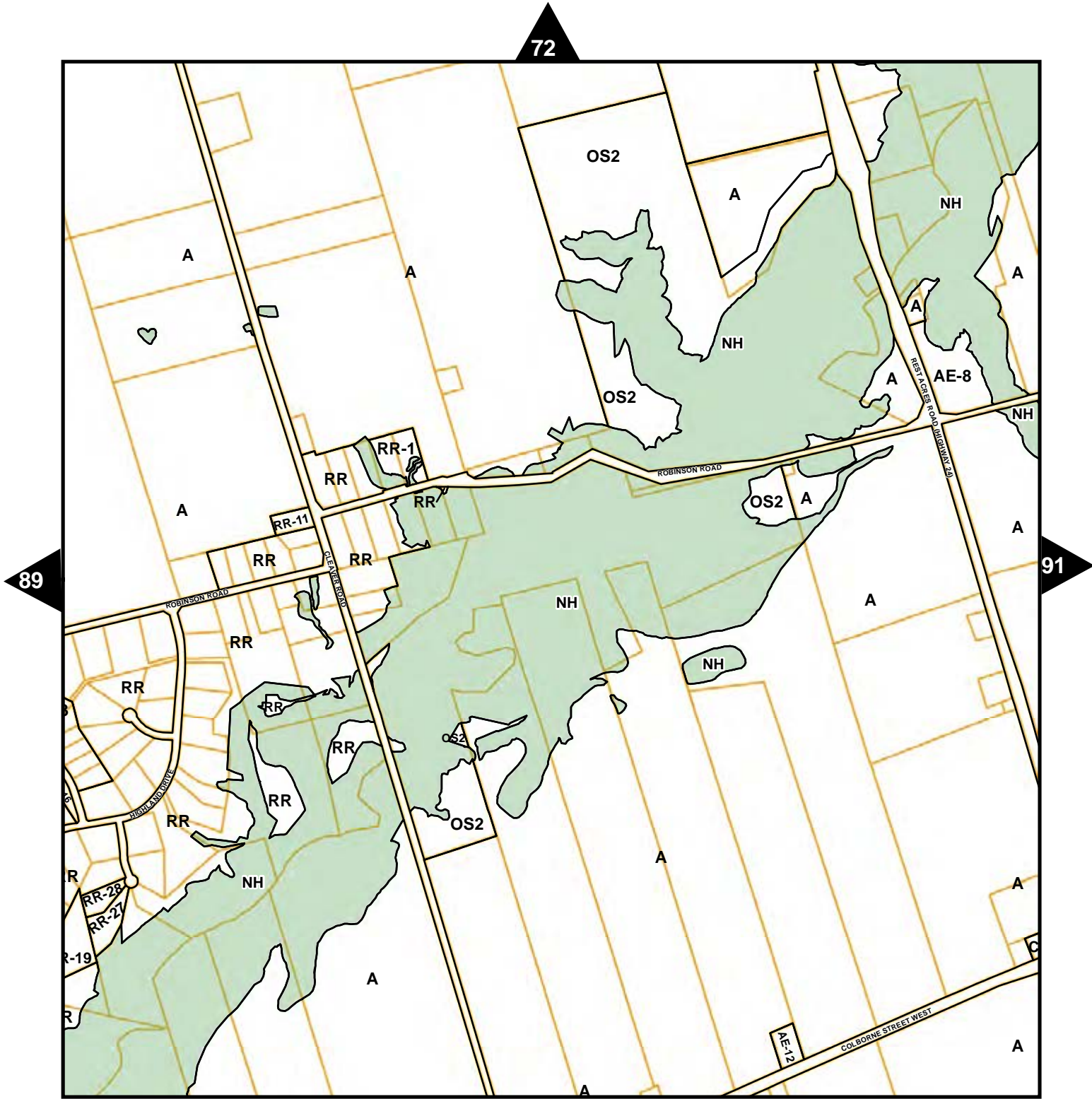

- Zoning
- Natural Heritage
- Parcel Fabric

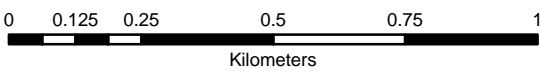

ZONING BY-LAW
SCHEDULE 'A'
Map No. 90



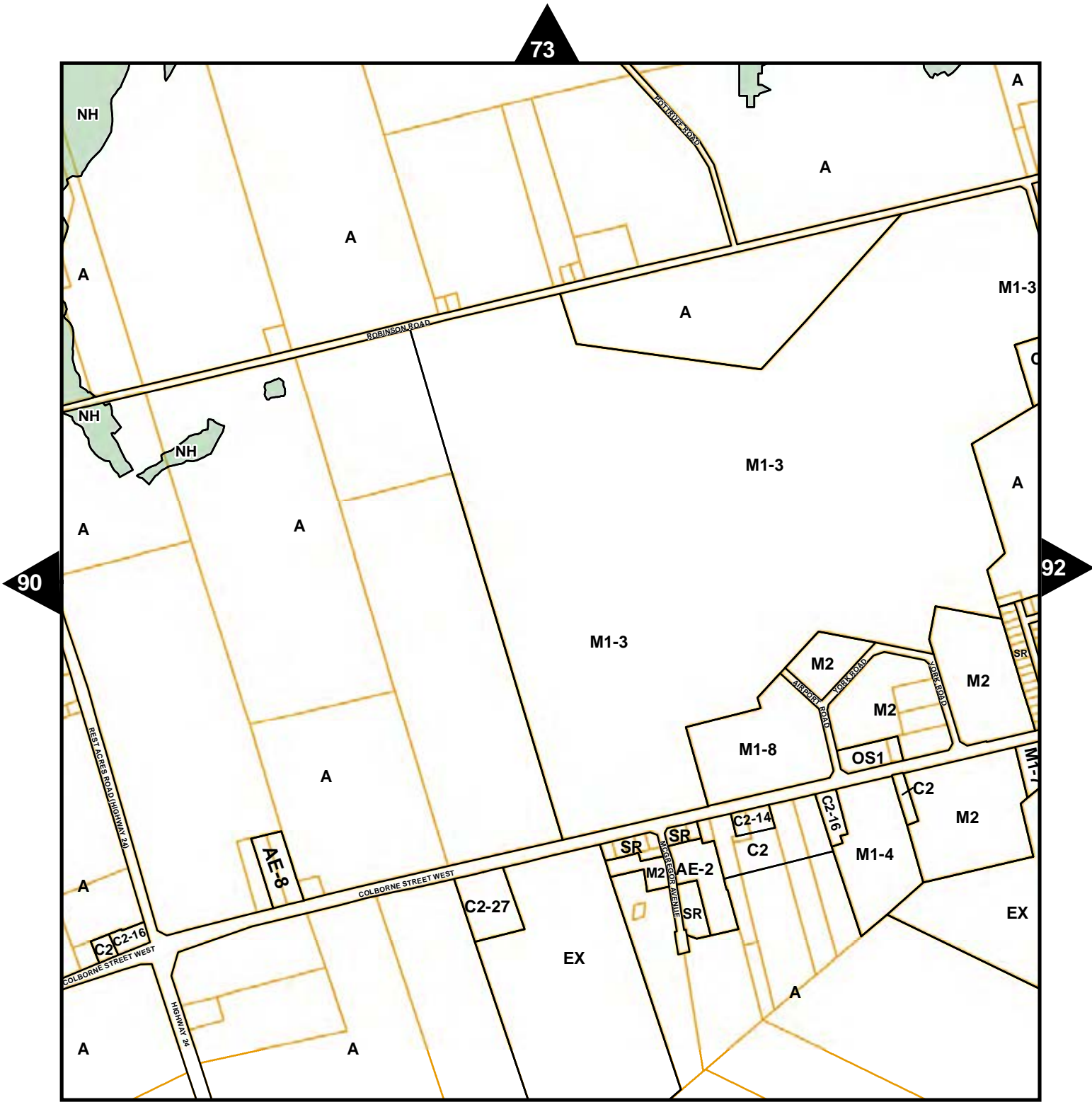

- Zoning
- Natural Heritage
- Parcel Fabric

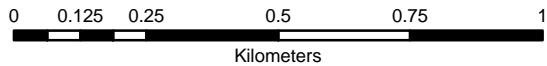

ZONING BY-LAW SCHEDULE 'A' Map No. 91



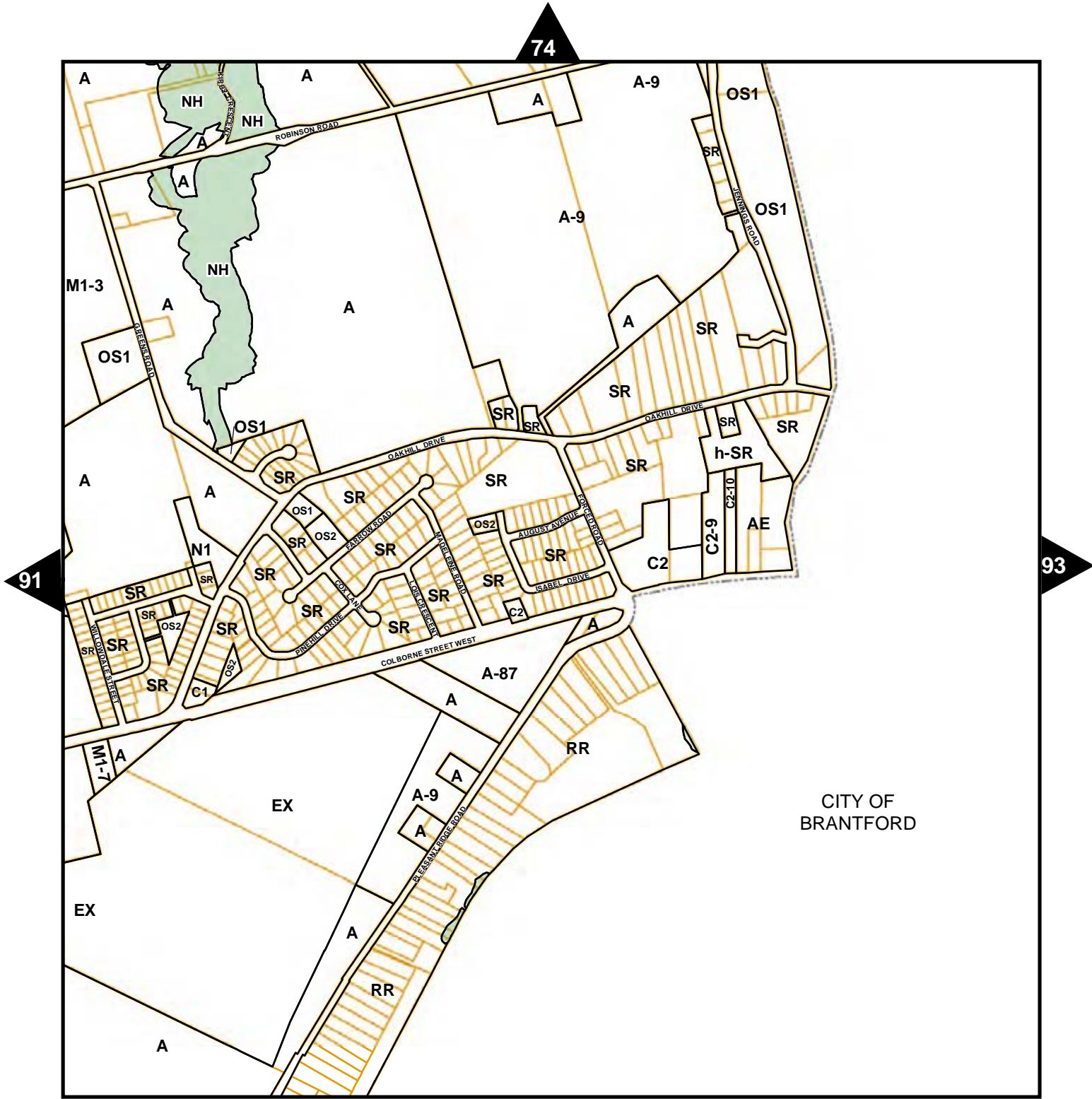

- Zoning
- Natural Heritage
- Parcel Fabric



ZONING BY-LAW SCHEDULE 'A' Map No. 92







112

92

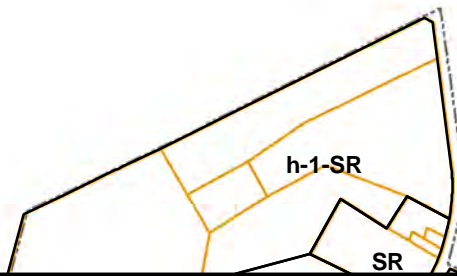
CITY OF
BRANTFORD

113



-  Zoning
-  Natural Heritage
-  Parcel Fabric

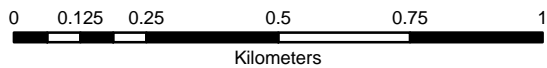

ZONING BY-LAW
SCHEDULE 'A'
Map No. 93



75

95

CITY OF BRANTFORD

A-66

A-66

A-66

NH

A

NH

A



115



ZONING BY-LAW

SCHEDULE 'A'

Map No. 94

-  Zoning
-  Natural Heritage
-  Parcel Fabric

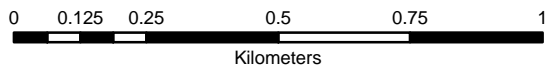

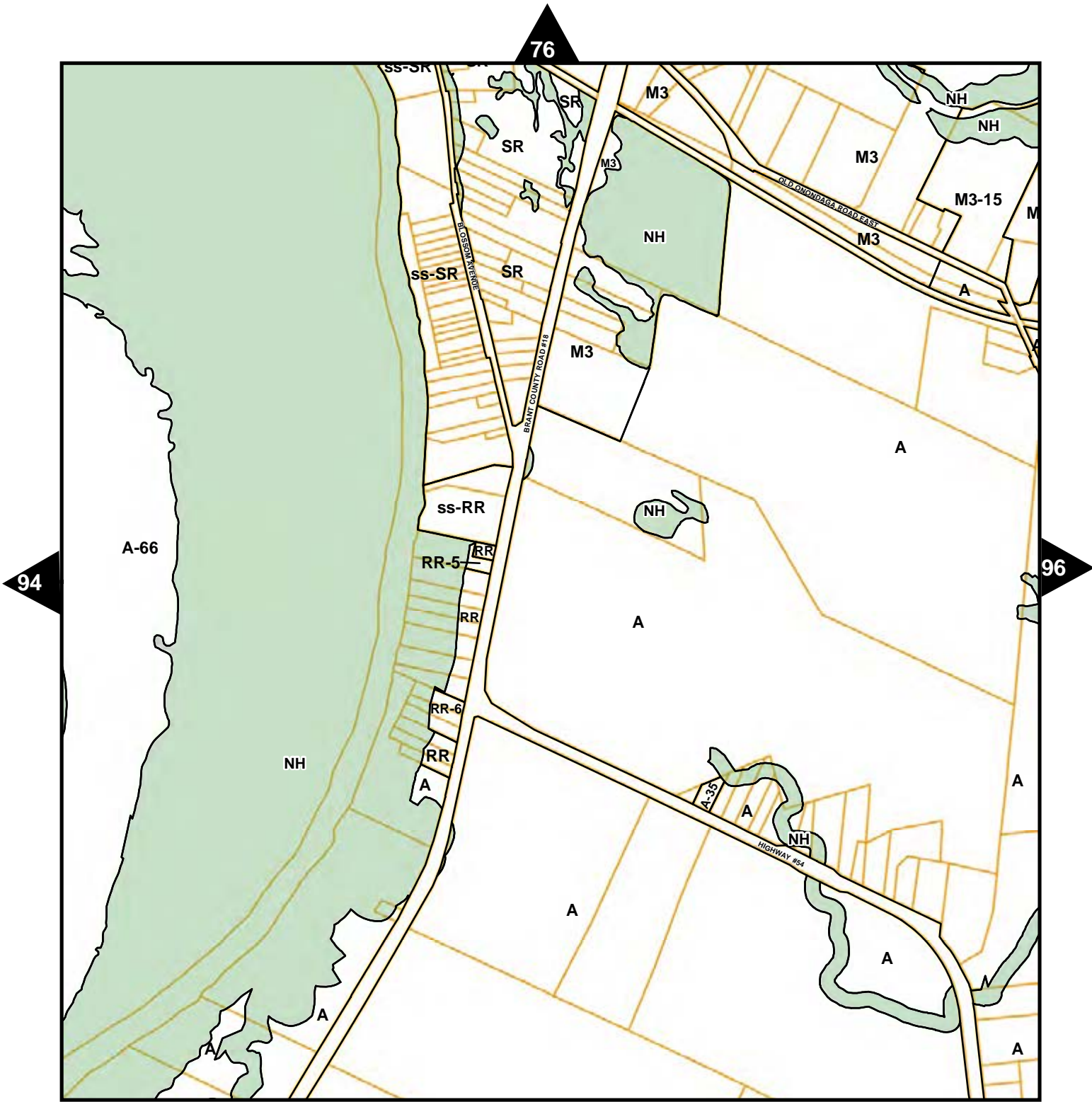





- Zoning
- Natural Heritage
- Parcel Fabric

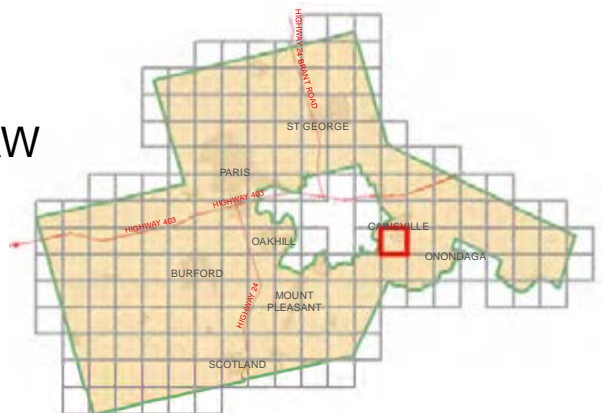

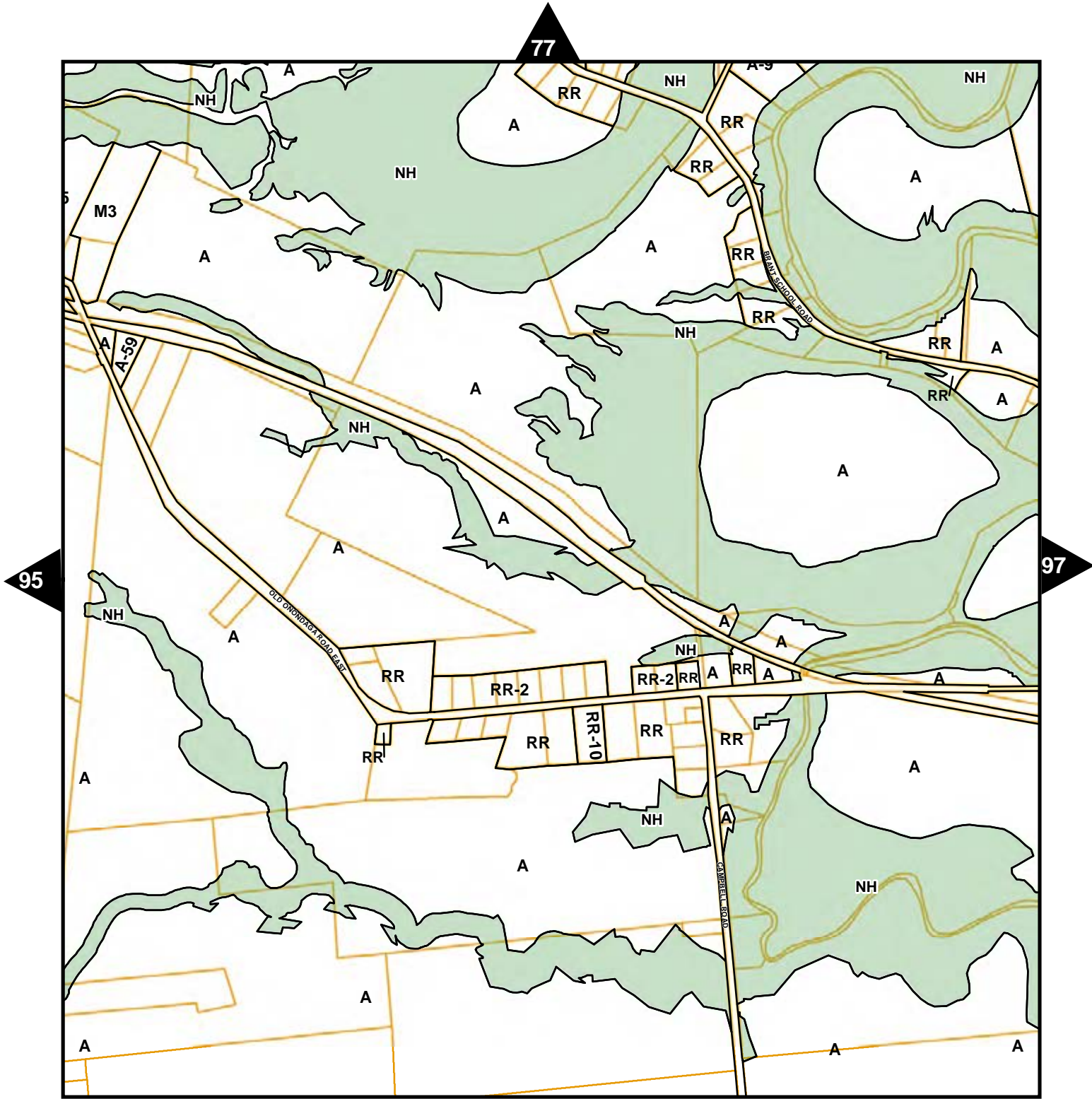
ZONING BY-LAW SCHEDULE 'A' Map No. 95





-  Zoning
-  Natural Heritage
-  Parcel Fabric



ZONING BY-LAW SCHEDULE 'A' Map No. 96

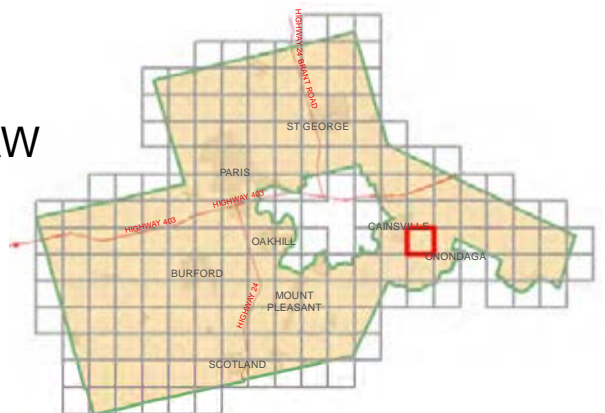

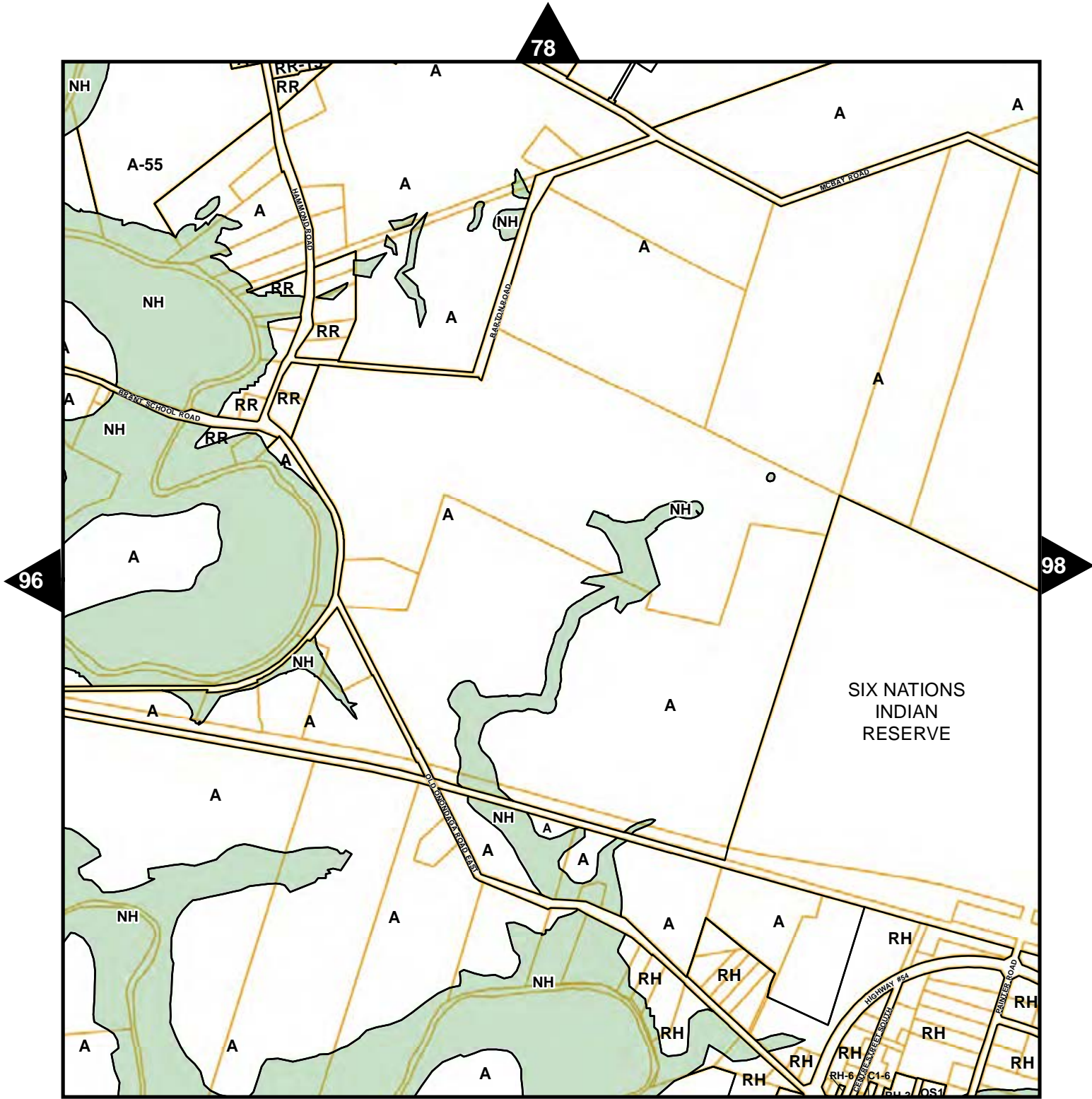

- Zoning
- Natural Heritage
- Parcel Fabric



ZONING BY-LAW SCHEDULE 'A' Map No. 97

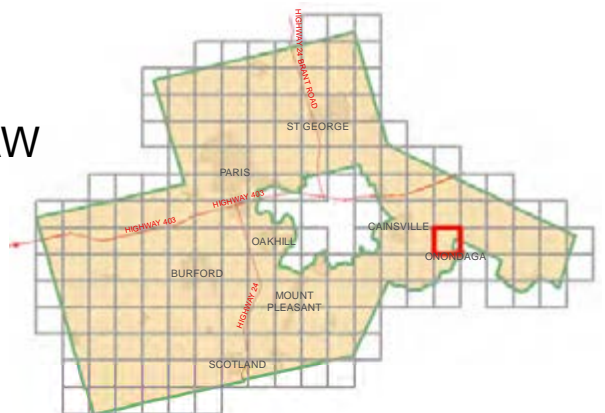

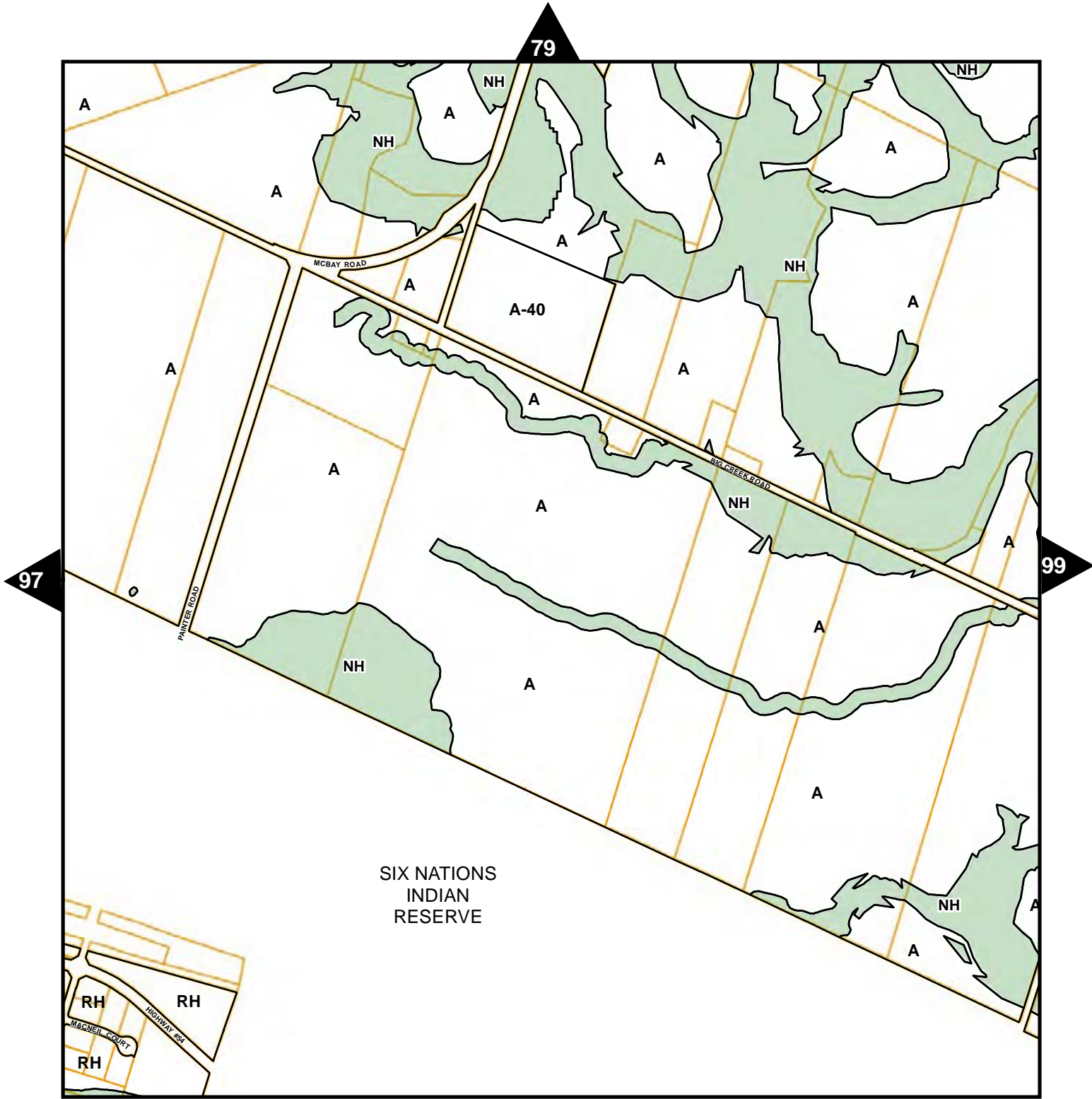

119



- Zoning
- Natural Heritage
- Parcel Fabric

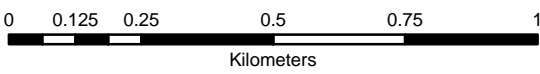

ZONING BY-LAW

SCHEDULE 'A'

Map No. 98



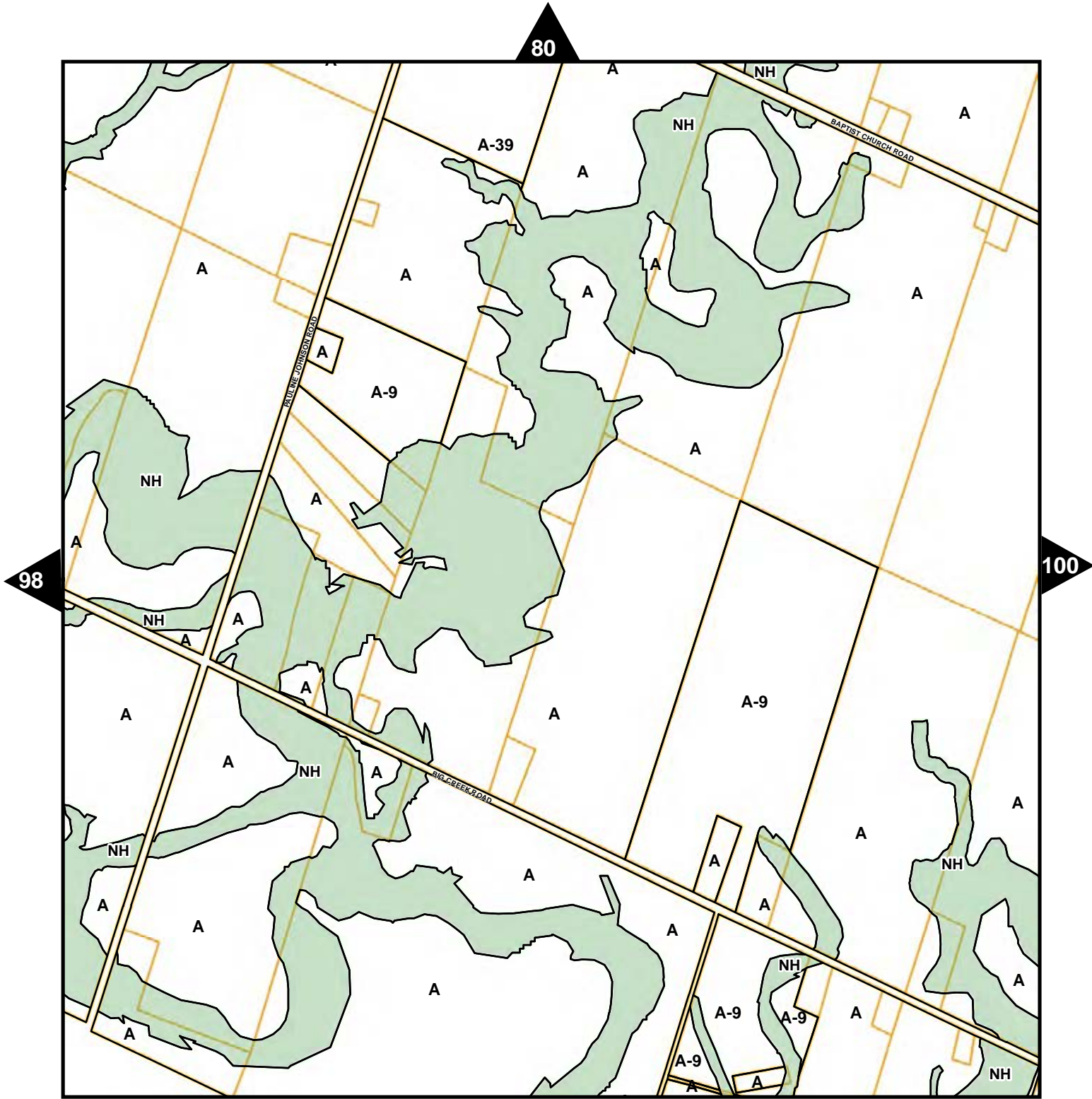

- Zoning
- Natural Heritage
- Parcel Fabric



ZONING BY-LAW
SCHEDULE 'A'
Map No. 99

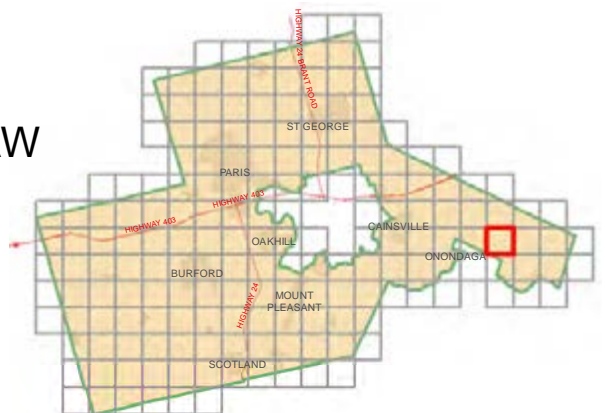

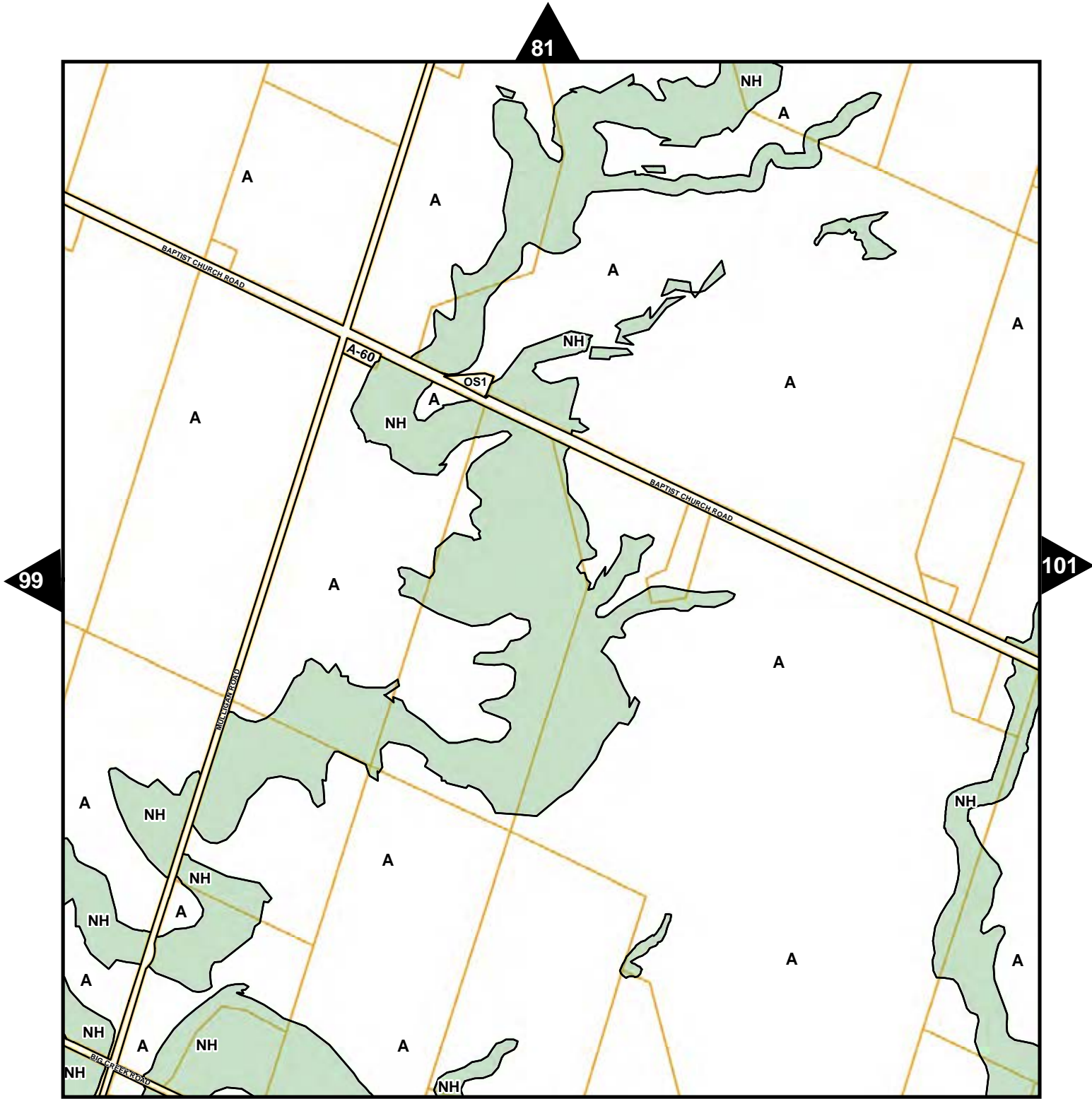

- Zoning
- Natural Heritage
- Parcel Fabric



ZONING BY-LAW SCHEDULE 'A' Map No. 100



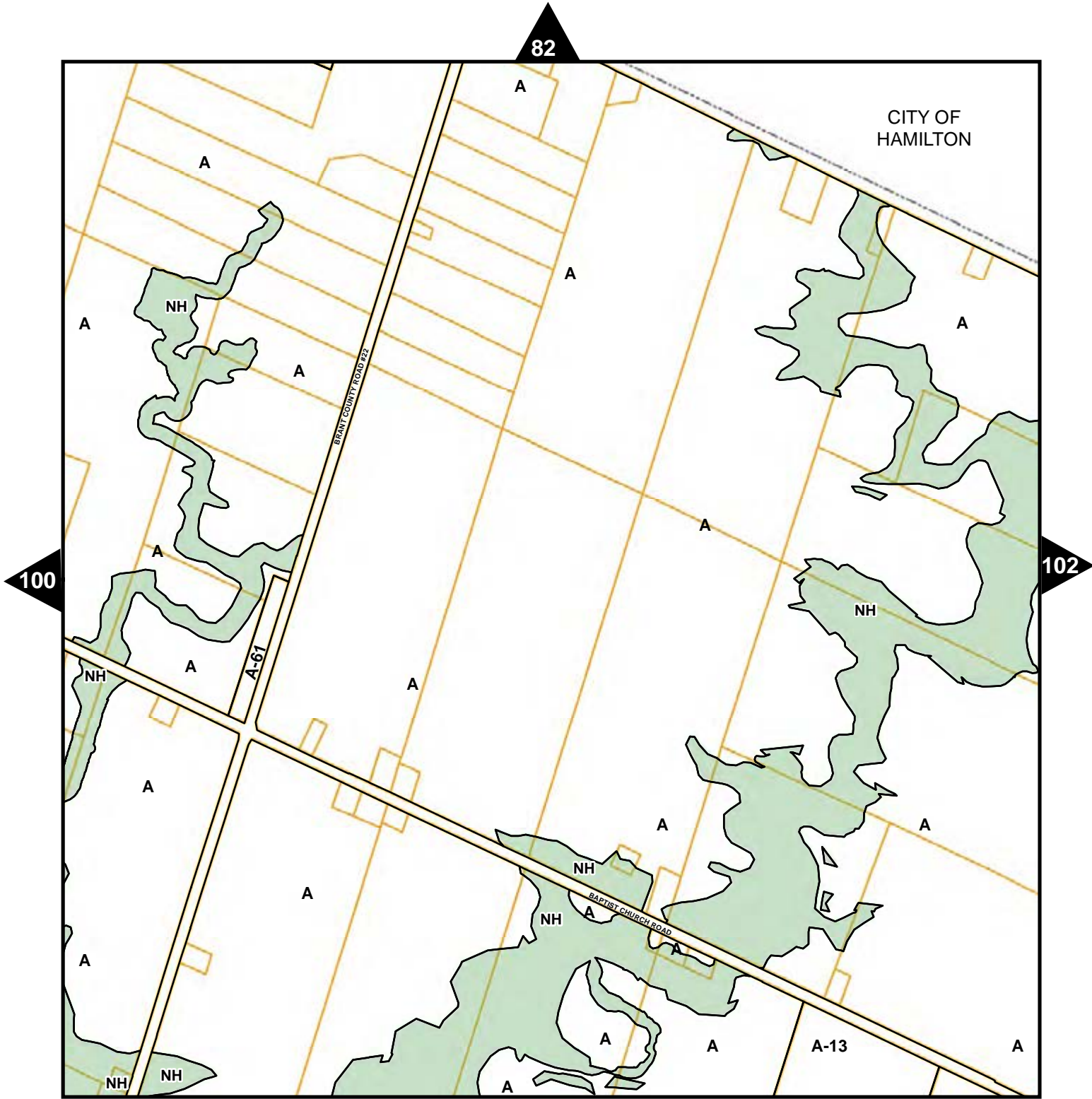

- Zoning
- Natural Heritage
- Parcel Fabric



ZONING BY-LAW
SCHEDULE 'A'
Map No. 101



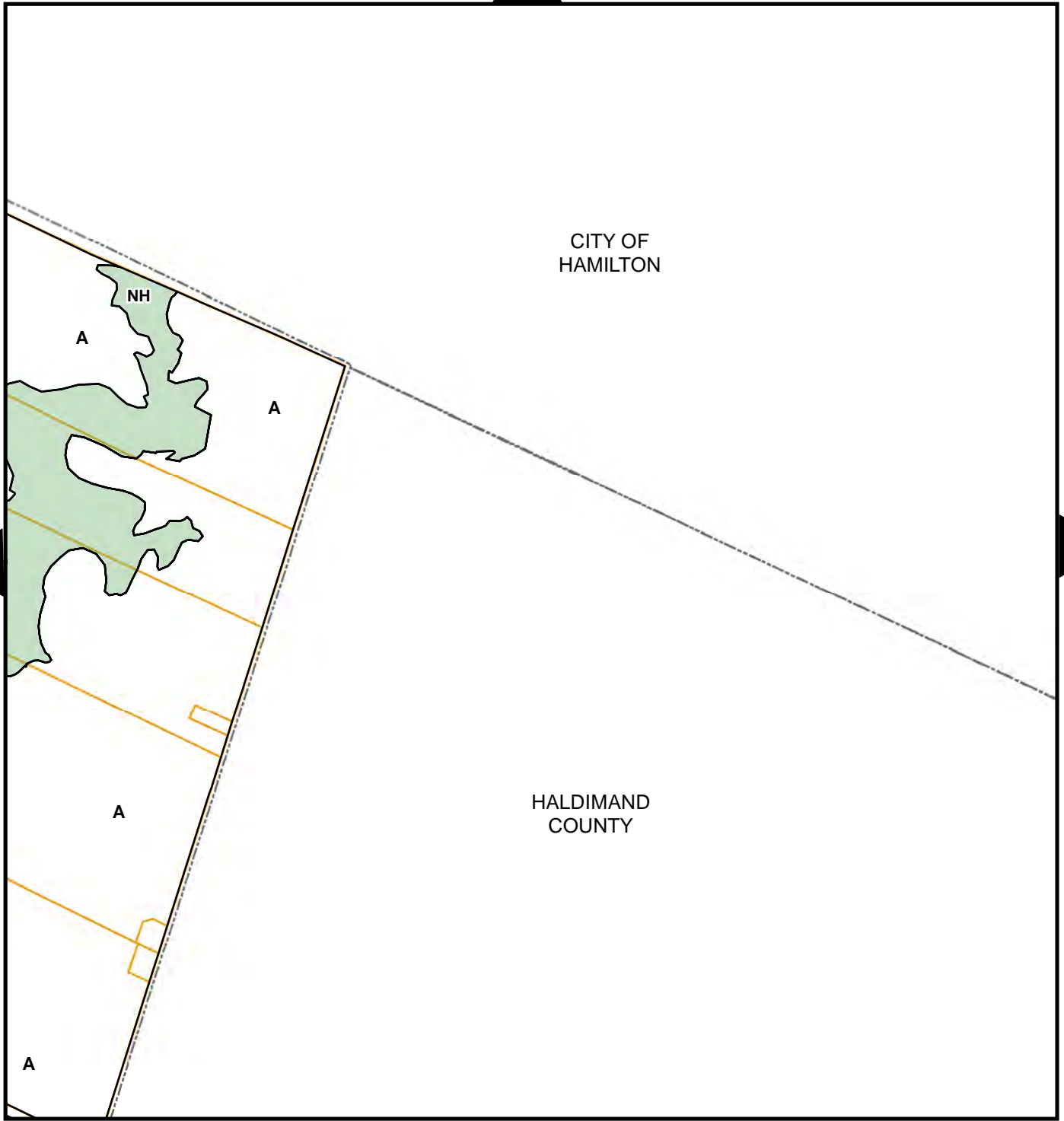

- Zoning
- Natural Heritage
- Parcel Fabric

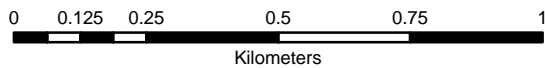

ZONING BY-LAW
SCHEDULE 'A'
Map No. 102



83

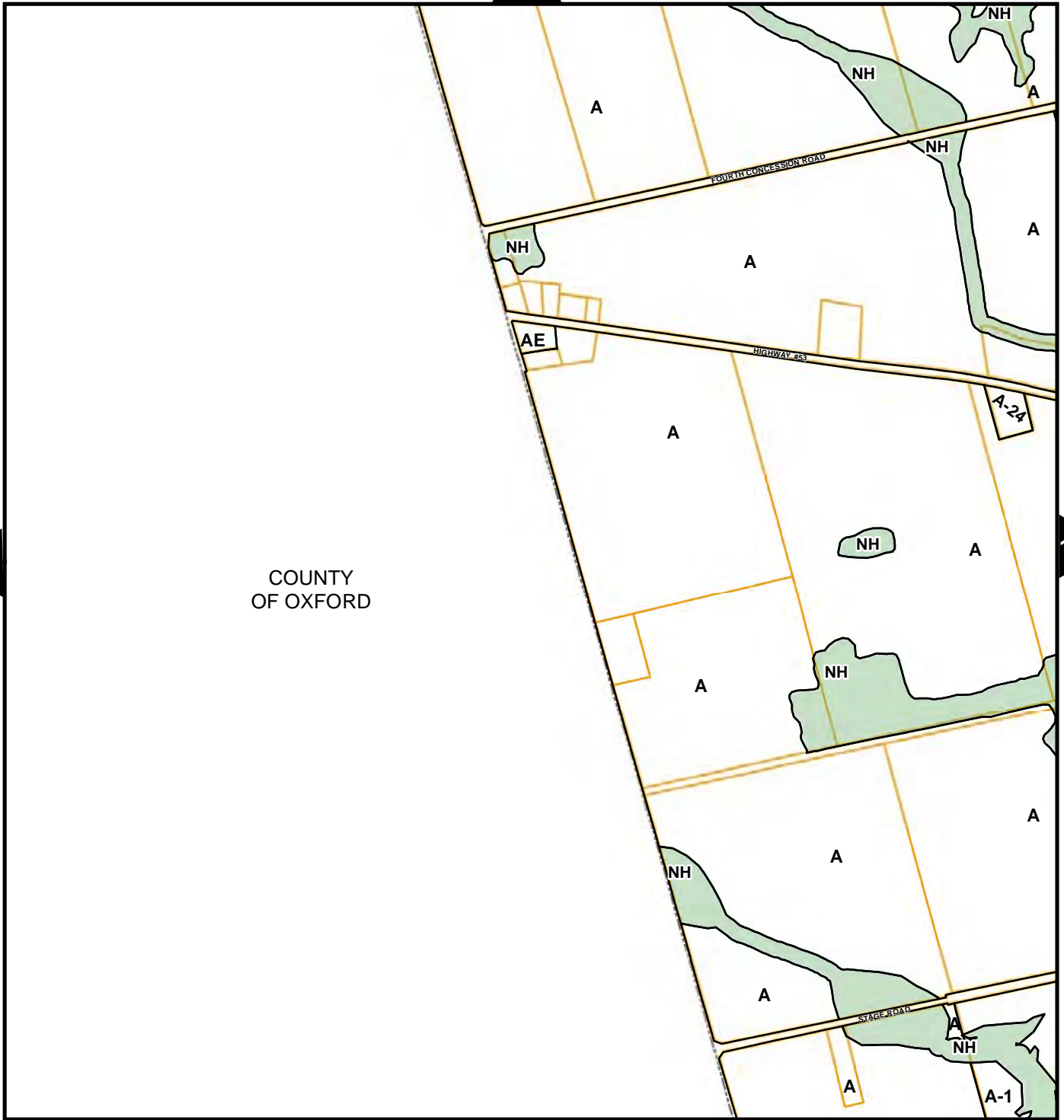



COUNTY OF OXFORD

104

124



ZONING BY-LAW
SCHEDULE 'A'
Map No. 103

-  Zoning
-  Natural Heritage
-  Parcel Fabric

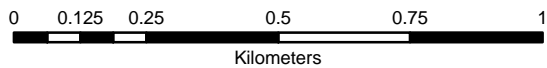

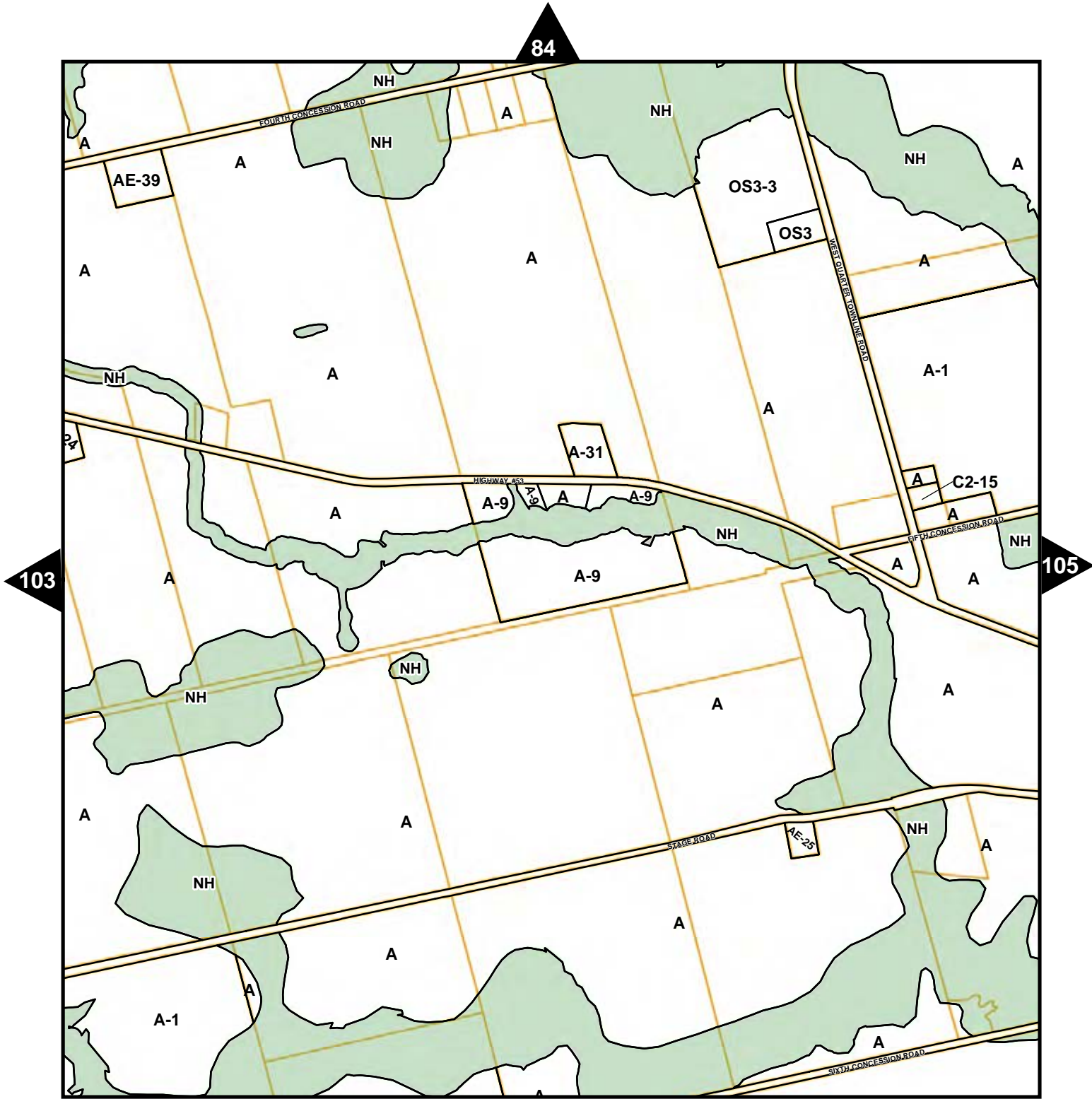

- Zoning
- Natural Heritage
- Parcel Fabric



ZONING BY-LAW
SCHEDULE 'A'
Map No. 104



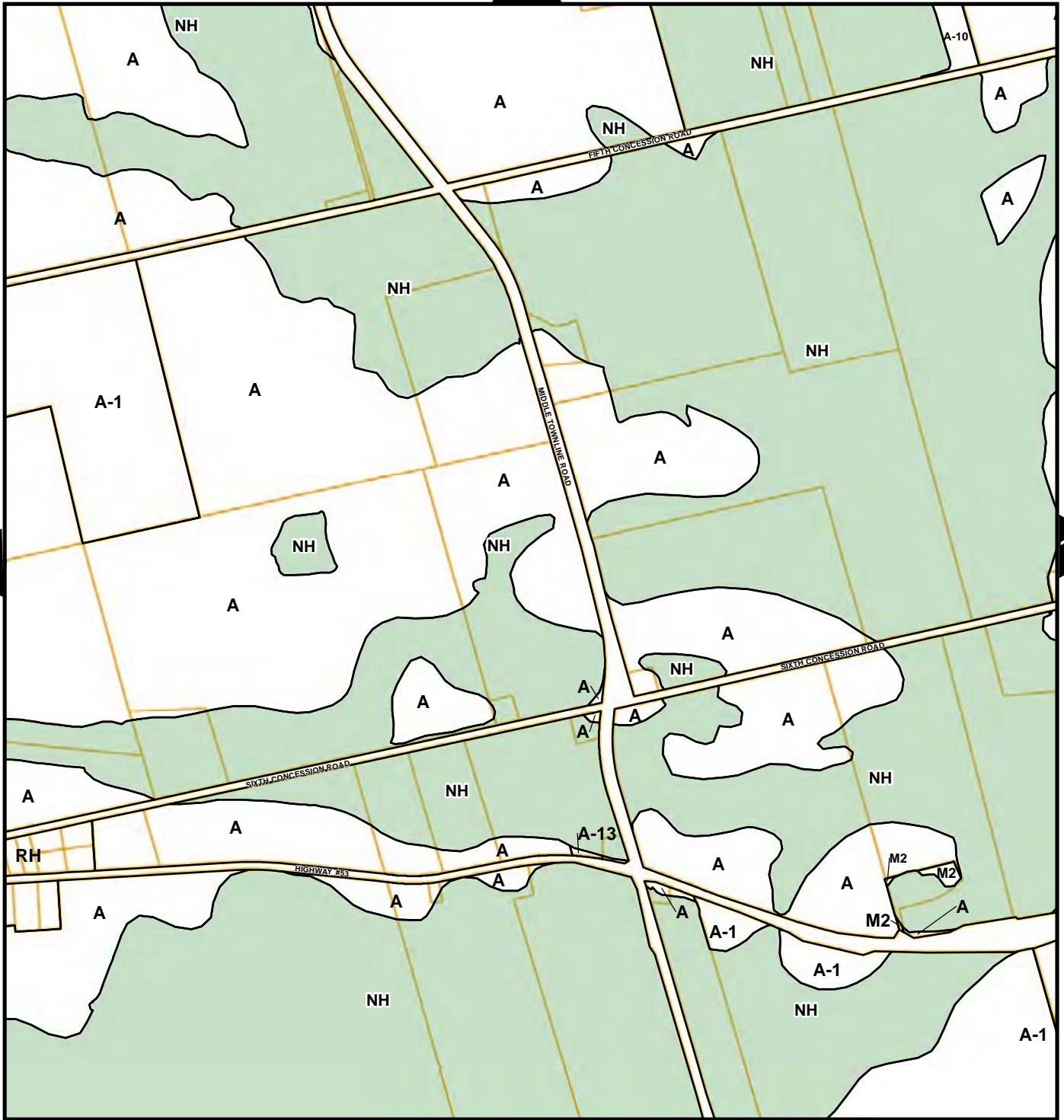

86



127



-  Zoning
-  Natural Heritage
-  Parcel Fabric

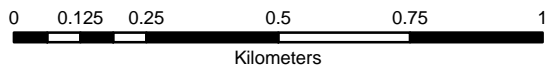

ZONING BY-LAW SCHEDULE 'A' Map No. 106



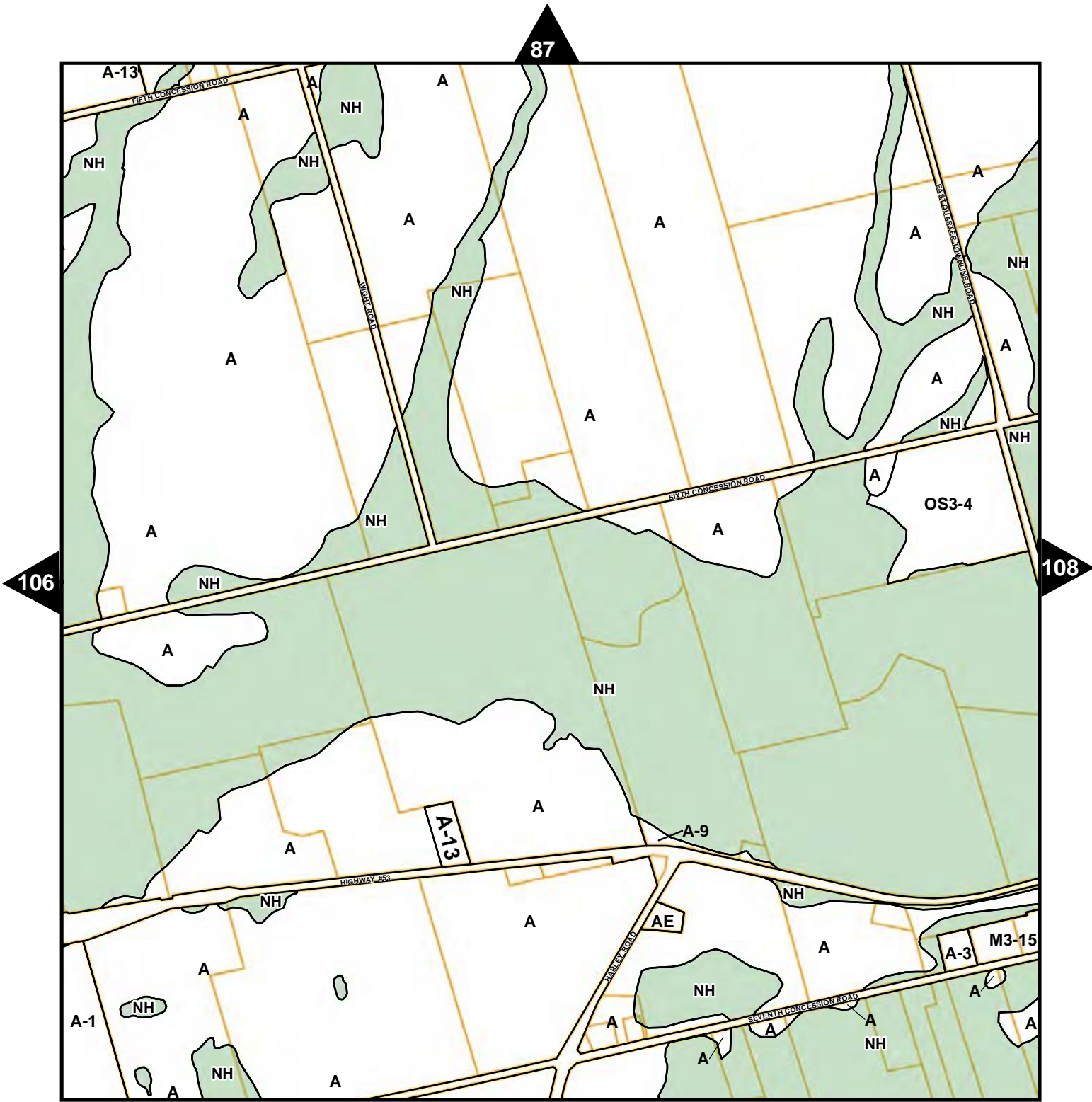

- Zoning
- Natural Heritage
- Parcel Fabric



ZONING BY-LAW SCHEDULE 'A'

Map No. 107



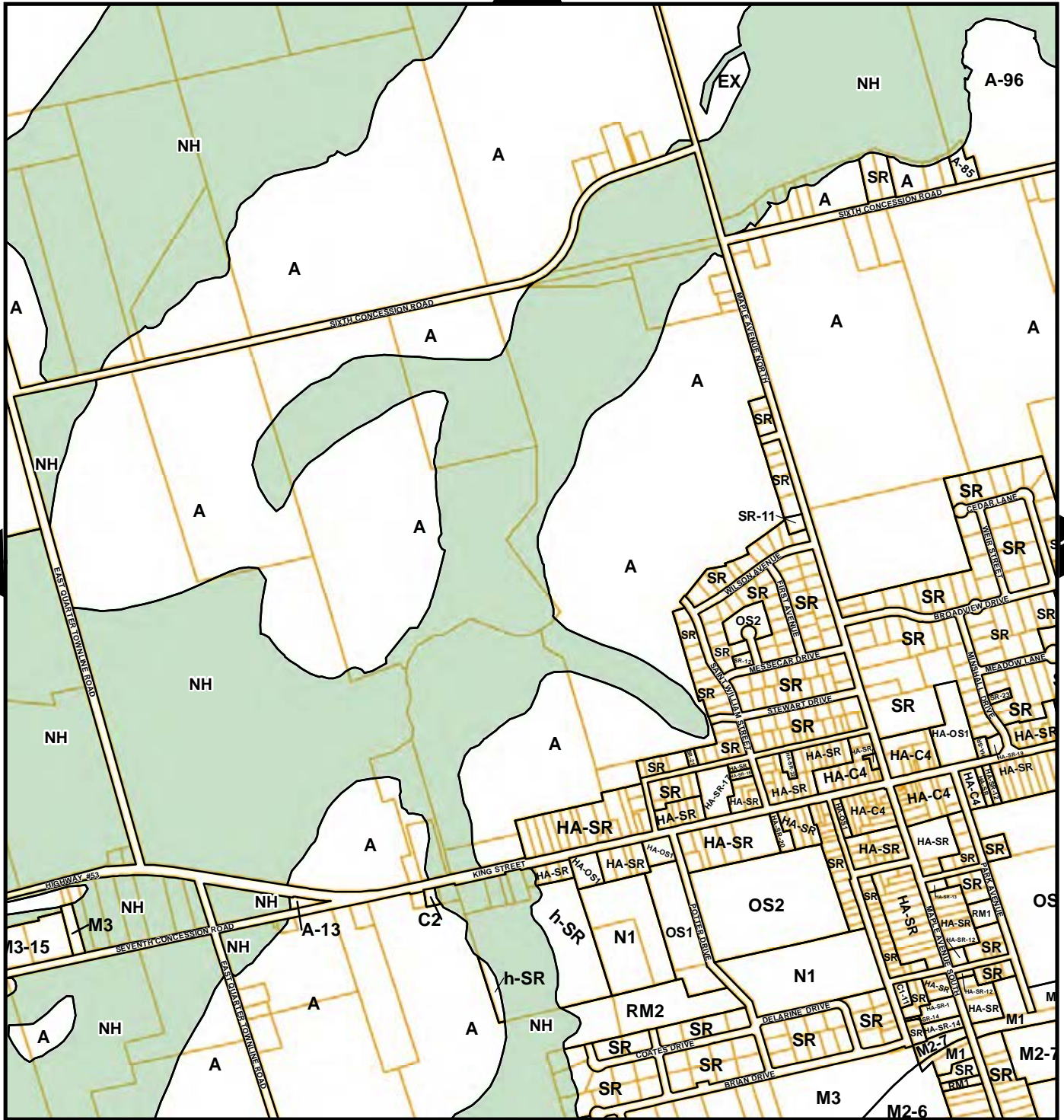



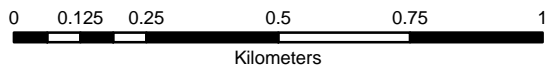

- Zoning
- Natural Heritage
- Parcel Fabric

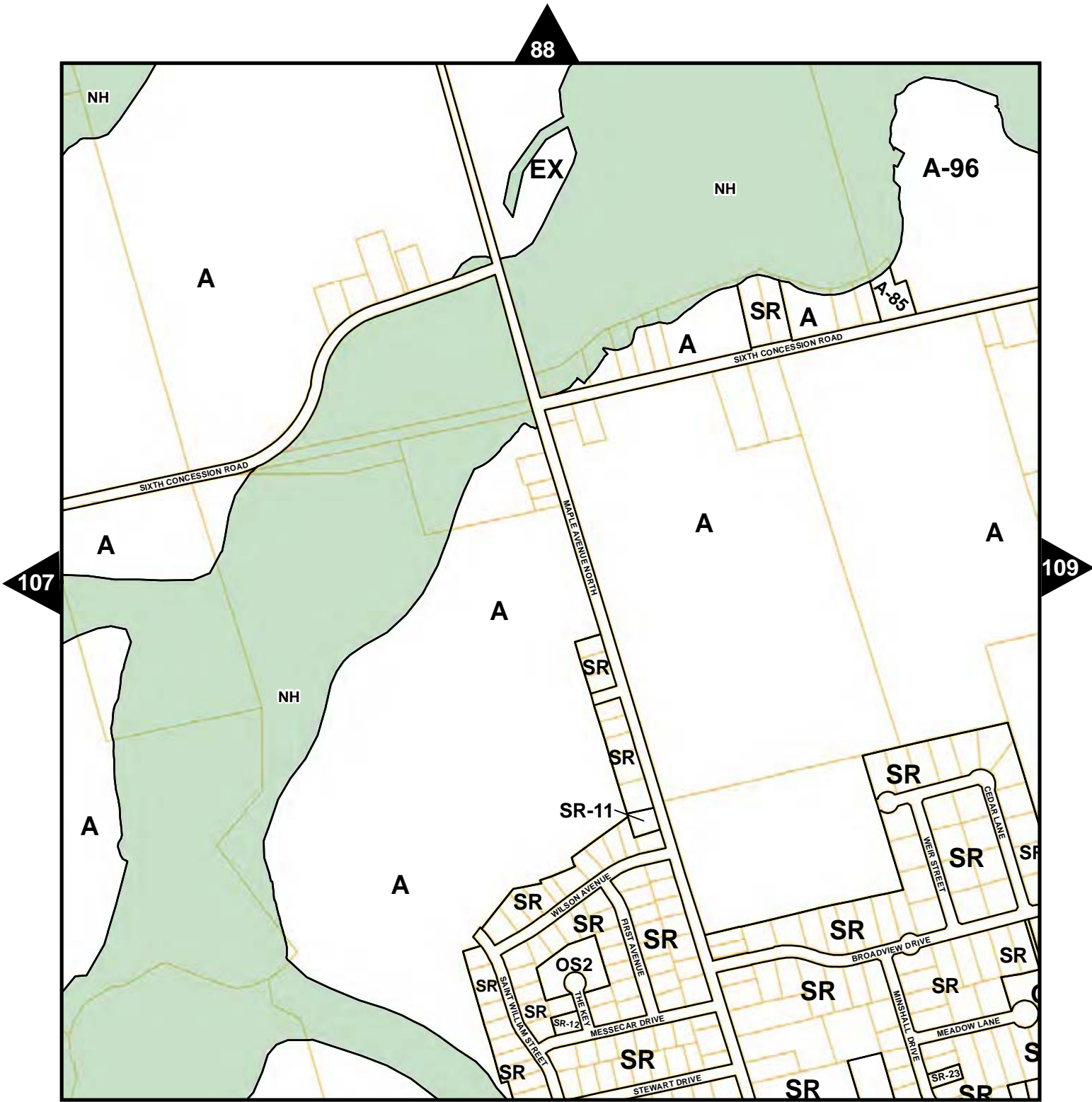

ZONING BY-LAW SCHEDULE 'A' Map No. 108





-  Zoning
-  Natural Hazard
-  Parcel Fabric

ZONING BY-LAW
SCHEDULE 'A'
Map No.108A

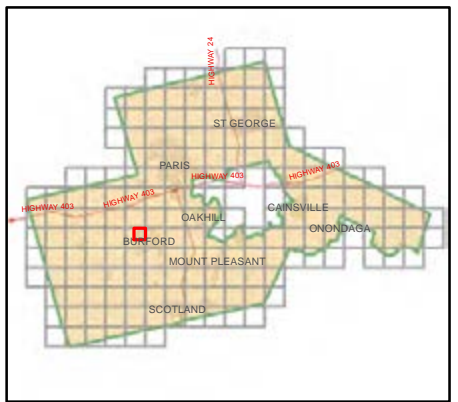
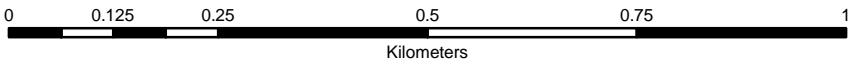

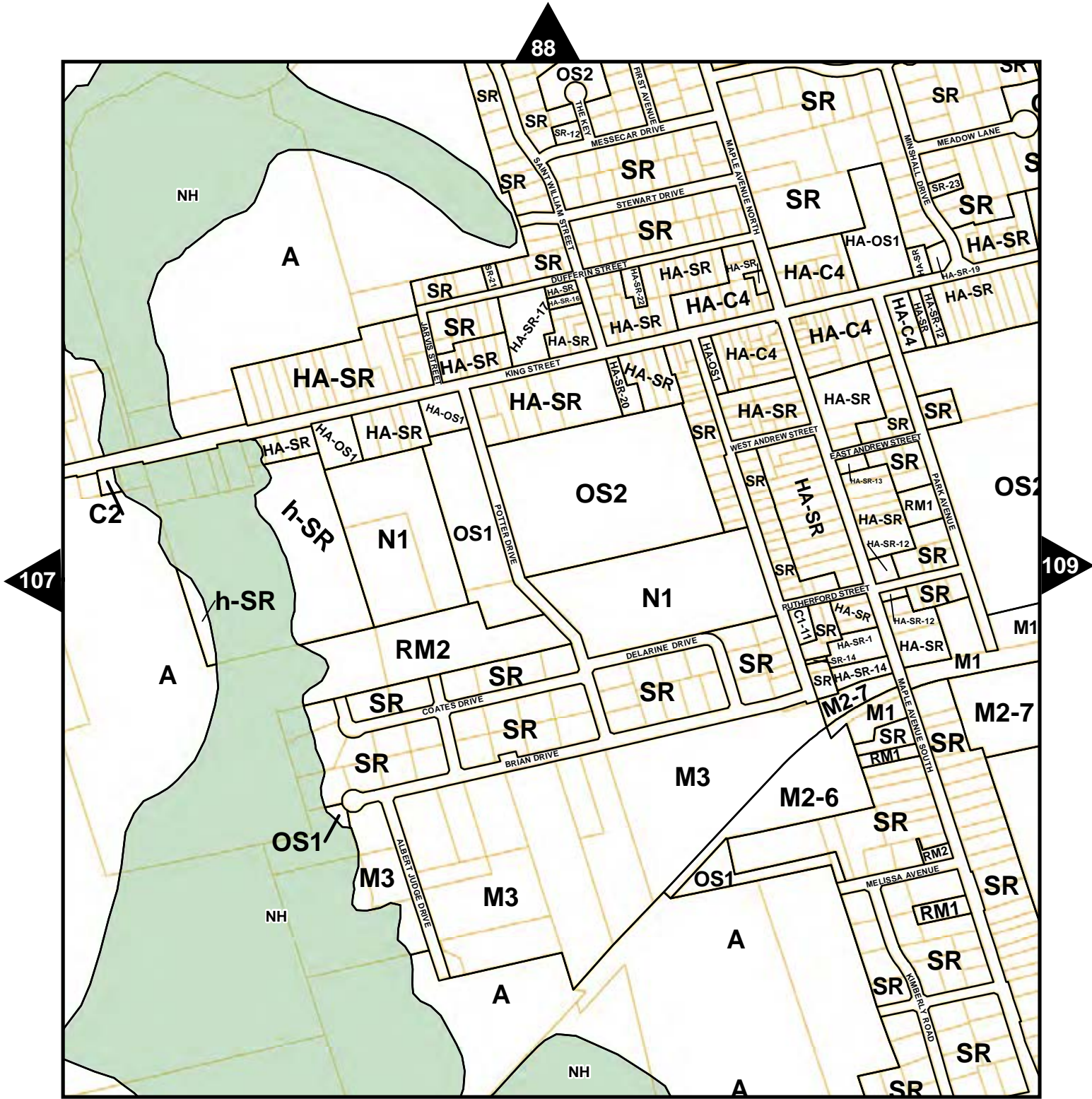

- Zoning
- Natural Hazard
- Parcel Fabric

ZONING BY-LAW
SCHEDULE 'A'
Map No.108B

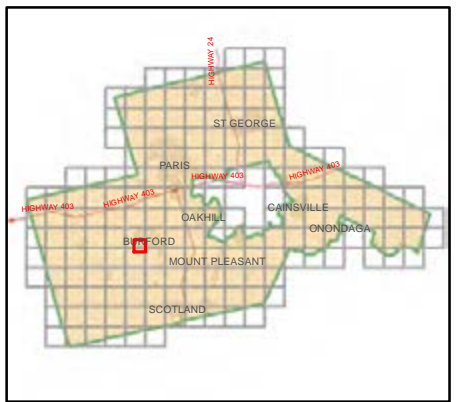
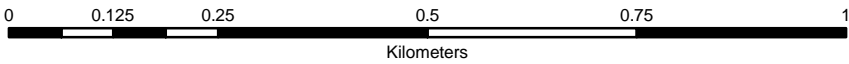

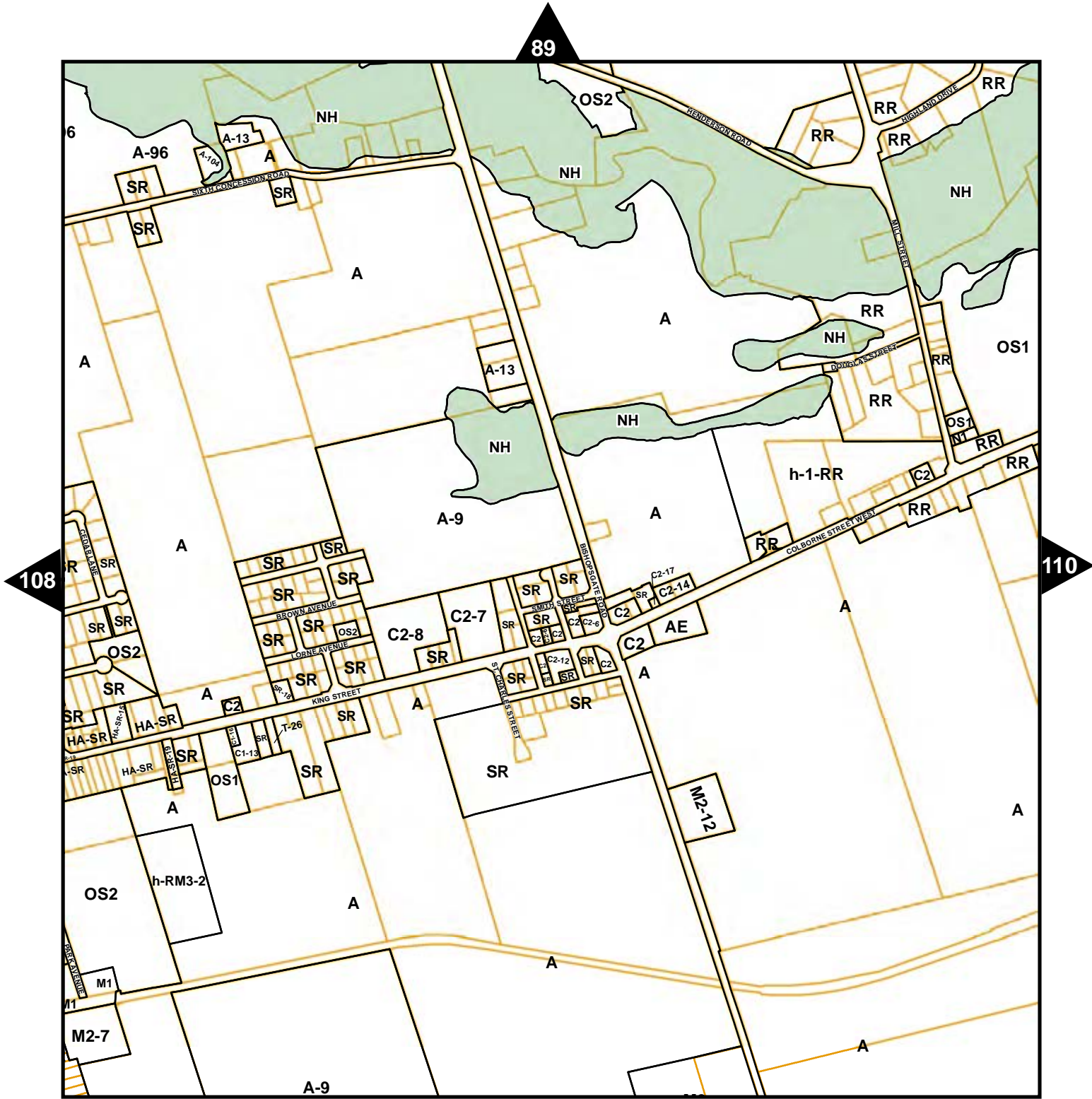

- Zoning
- Natural Heritage
- Parcel Fabric



ZONING BY-LAW SCHEDULE 'A' Map No. 109



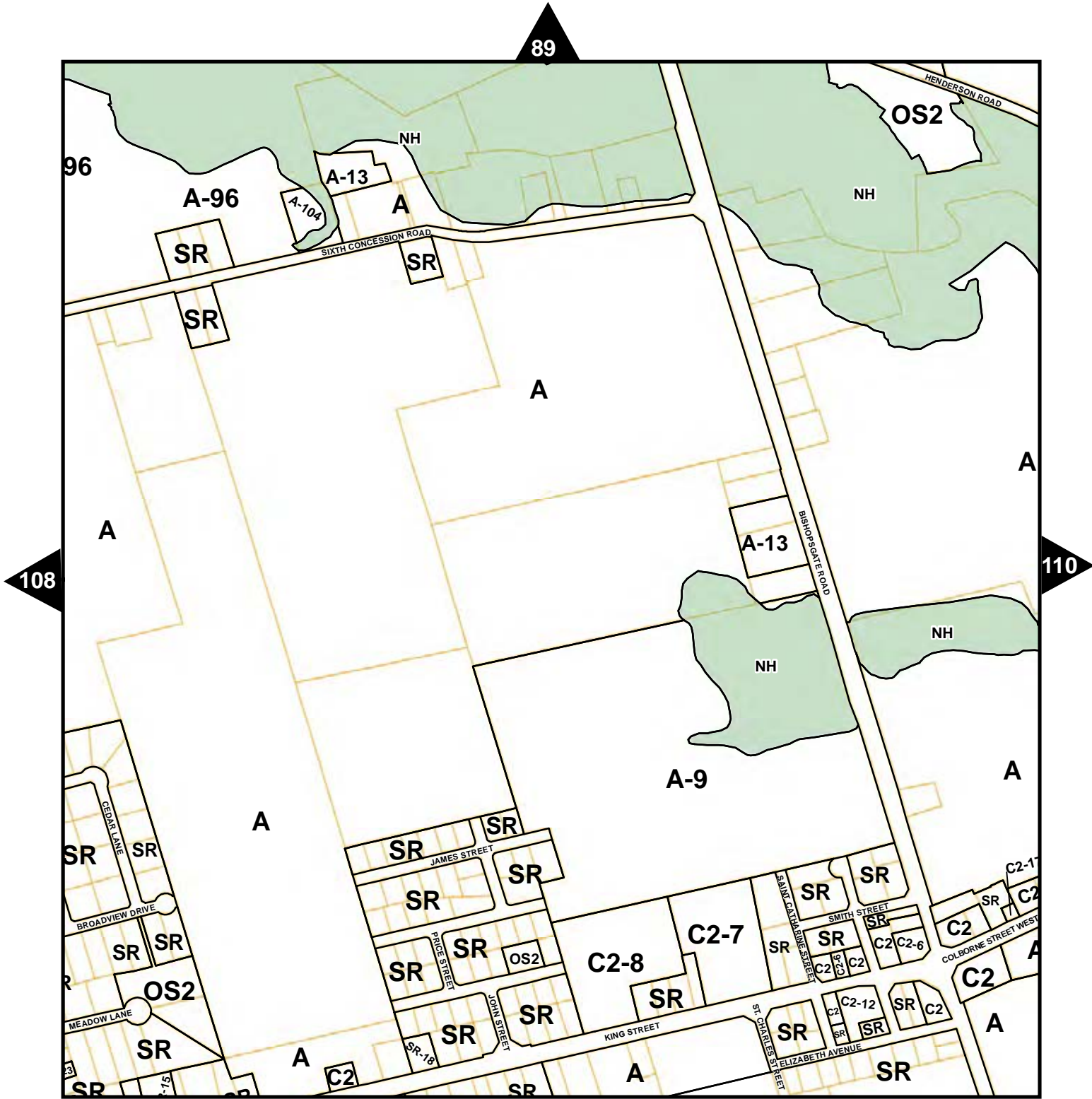

ZONING BY-LAW
SCHEDULE 'A'
Map No.109A

- Zoning
- Natural Hazard
- Parcel Fabric

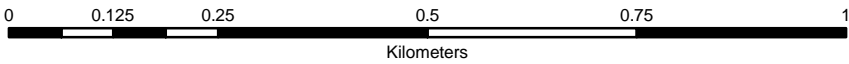



- Zoning
- Natural Hazard
- Parcel Fabric

ZONING BY-LAW
SCHEDULE 'A'
Map No.109B

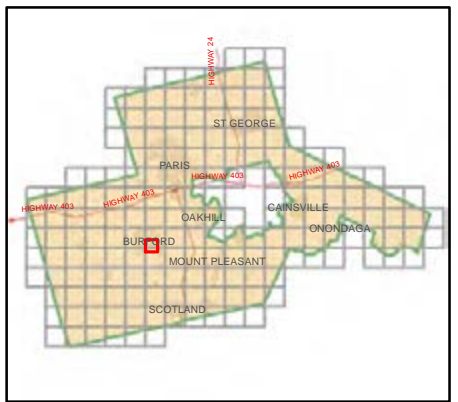
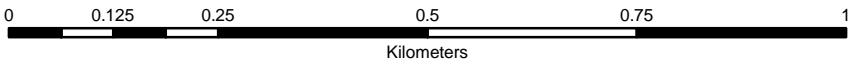

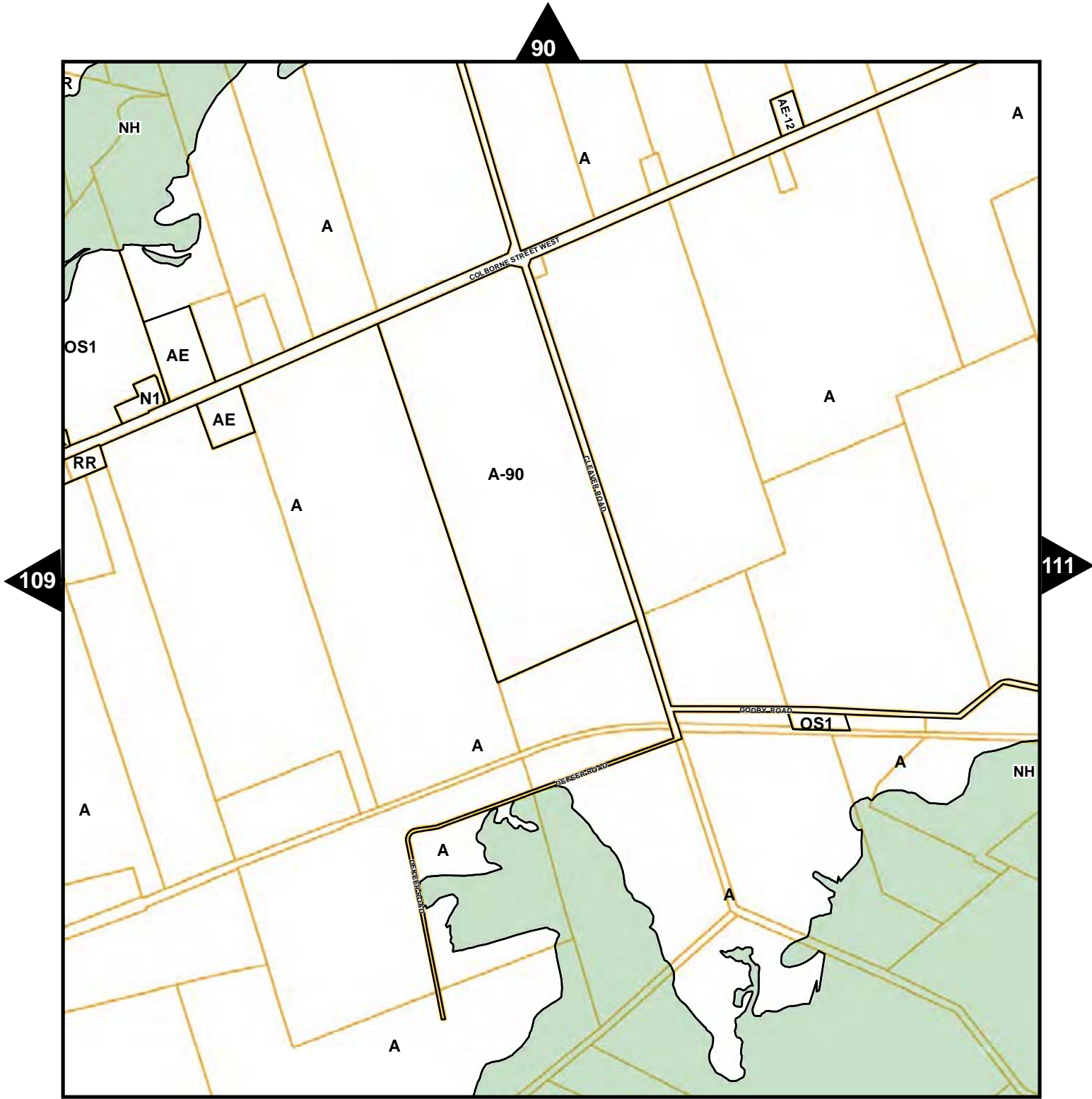

- Zoning
- Natural Heritage
- Parcel Fabric



ZONING BY-LAW SCHEDULE 'A' Map No. 110



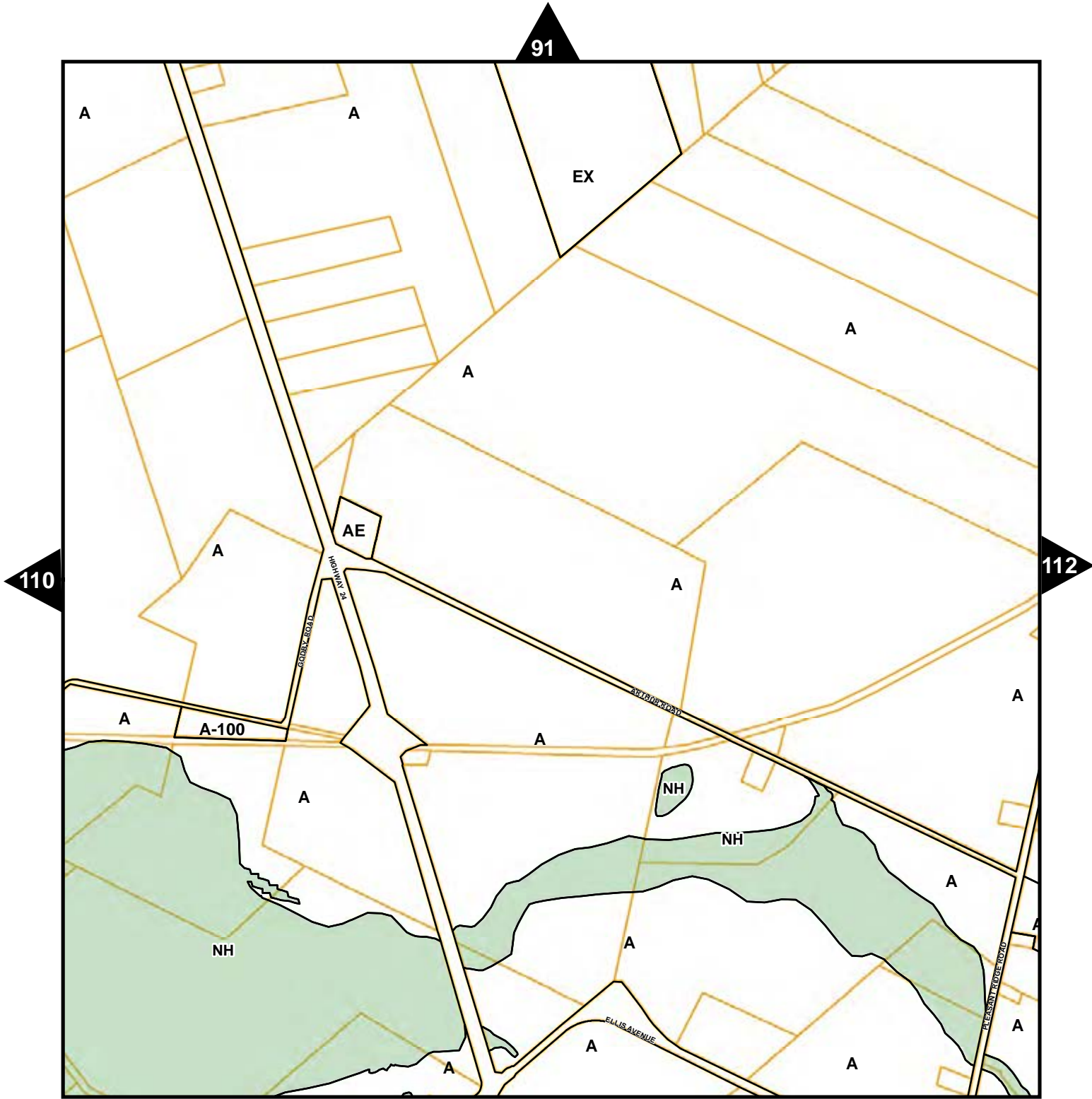





- Zoning
- Natural Heritage
- Parcel Fabric

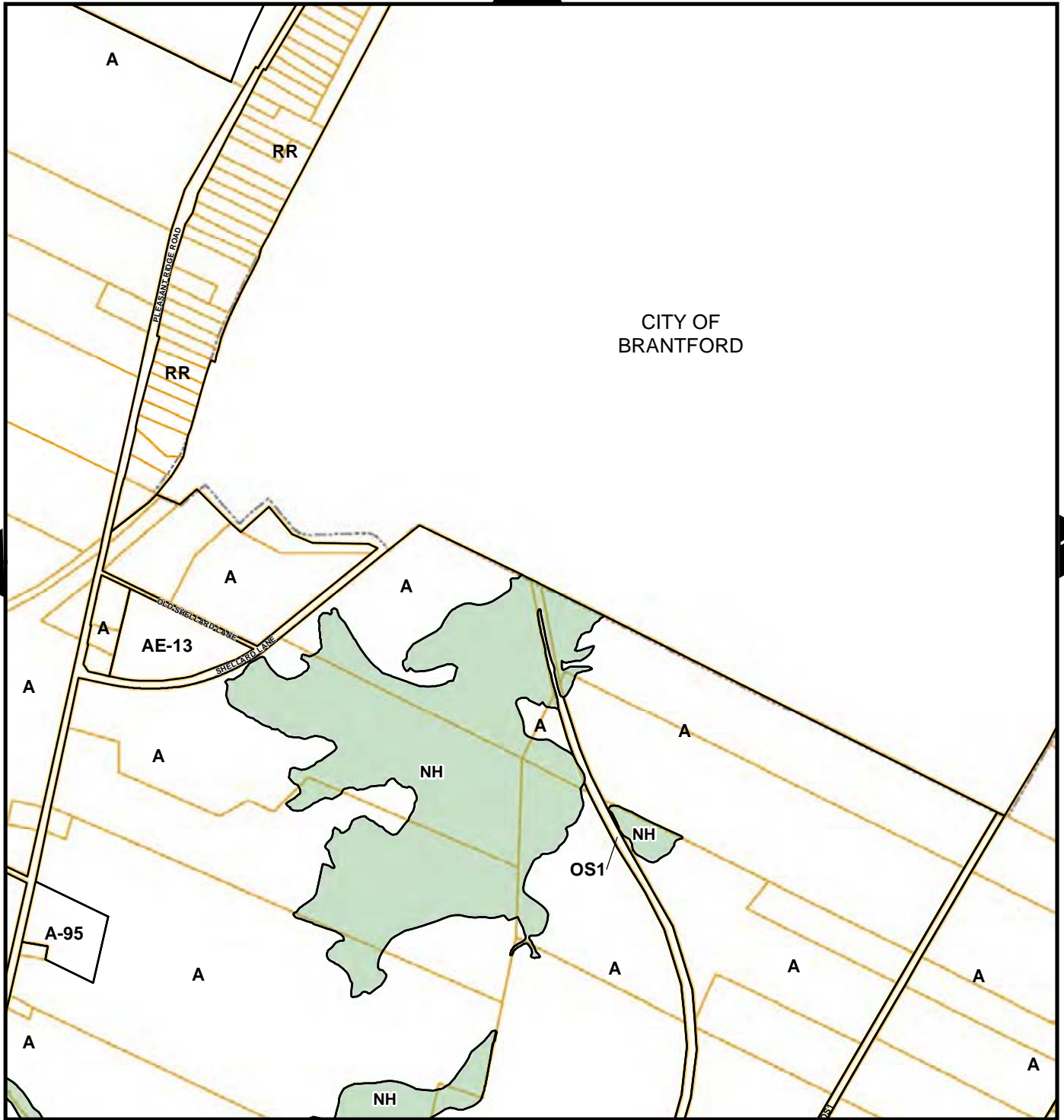

ZONING BY-LAW SCHEDULE 'A' Map No. 111





-  Zoning
-  Natural Heritage
-  Parcel Fabric

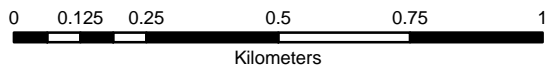

ZONING BY-LAW
SCHEDULE 'A'
Map No. 112

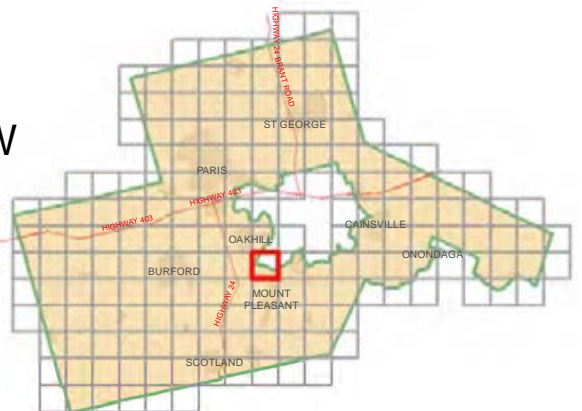

93

CITY OF BRANTFORD

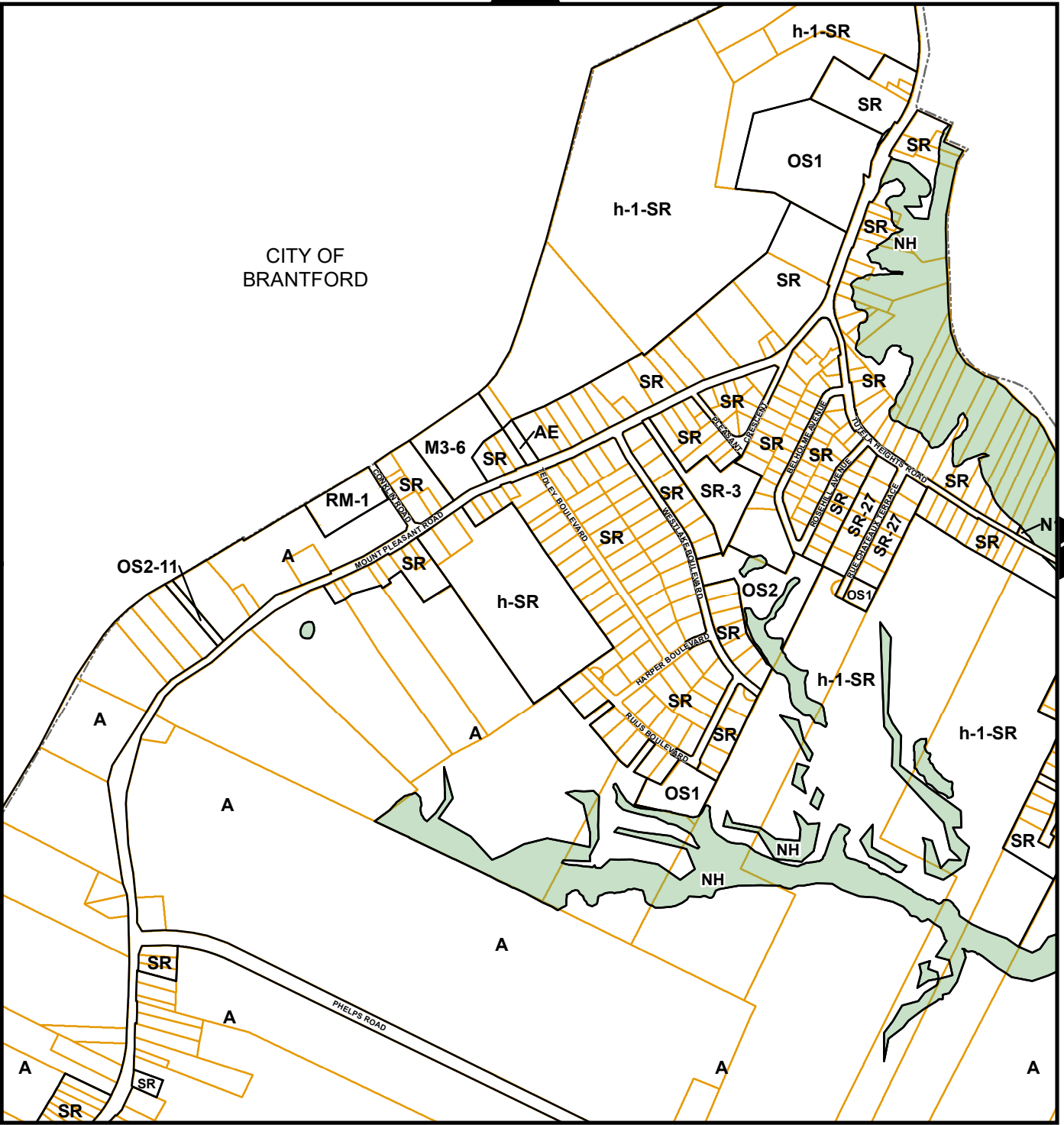

112

114

134



ZONING BY-LAW SCHEDULE 'A'

Map No. 113

- Zoning
- Natural Heritage
- Parcel Fabric

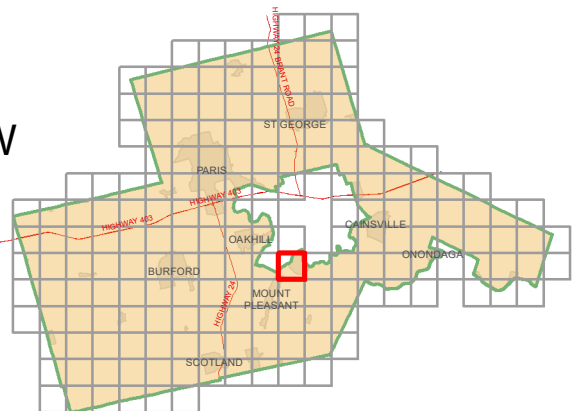
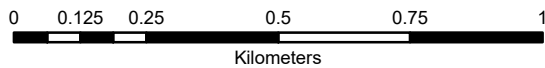

CITY OF
BRANTFORD

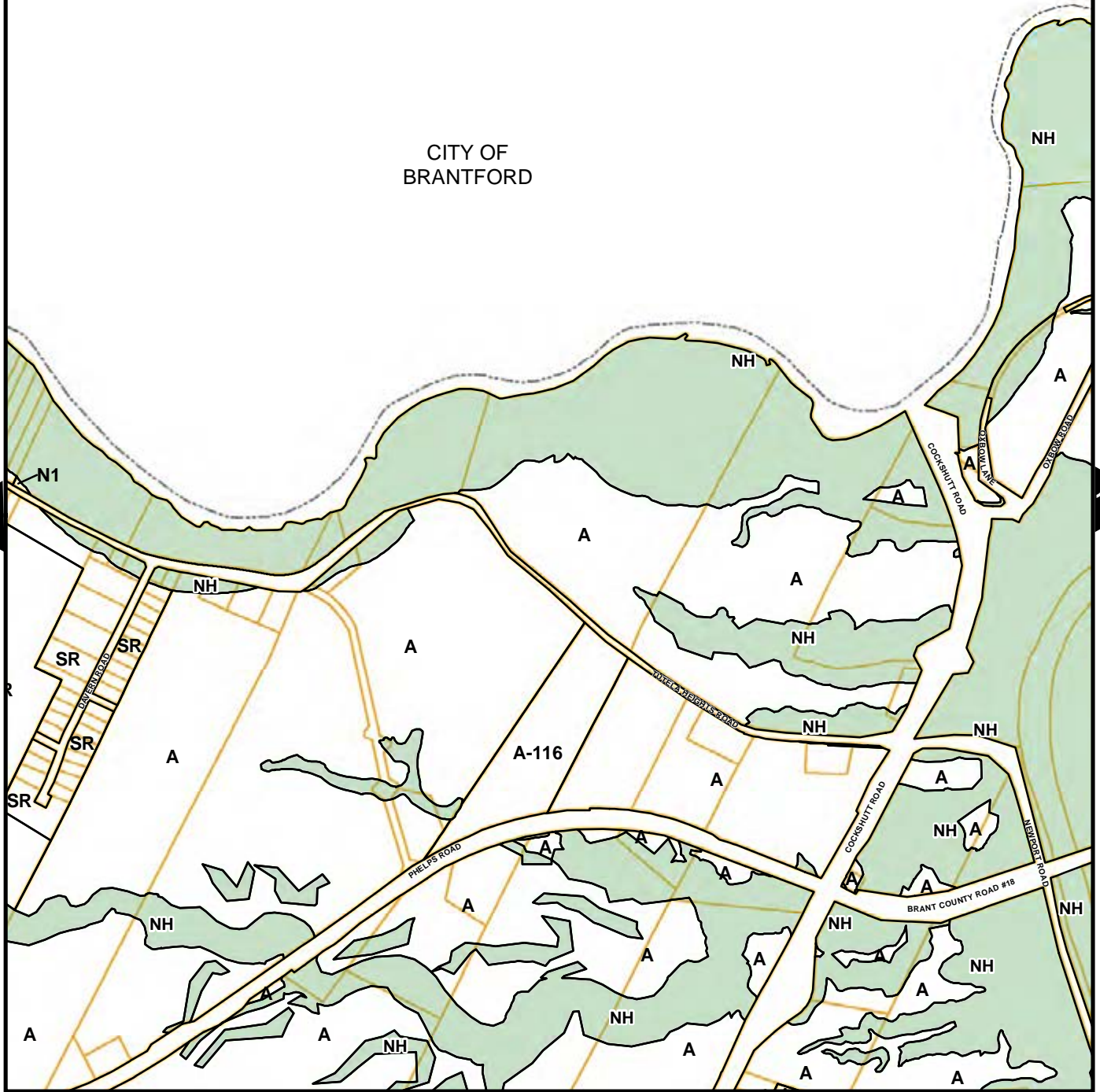

- Zoning
- Natural Heritage
- Parcel Fabric

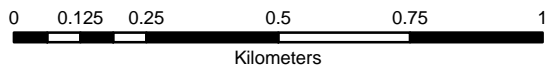

ZONING BY-LAW
SCHEDULE 'A'

Map No. 114



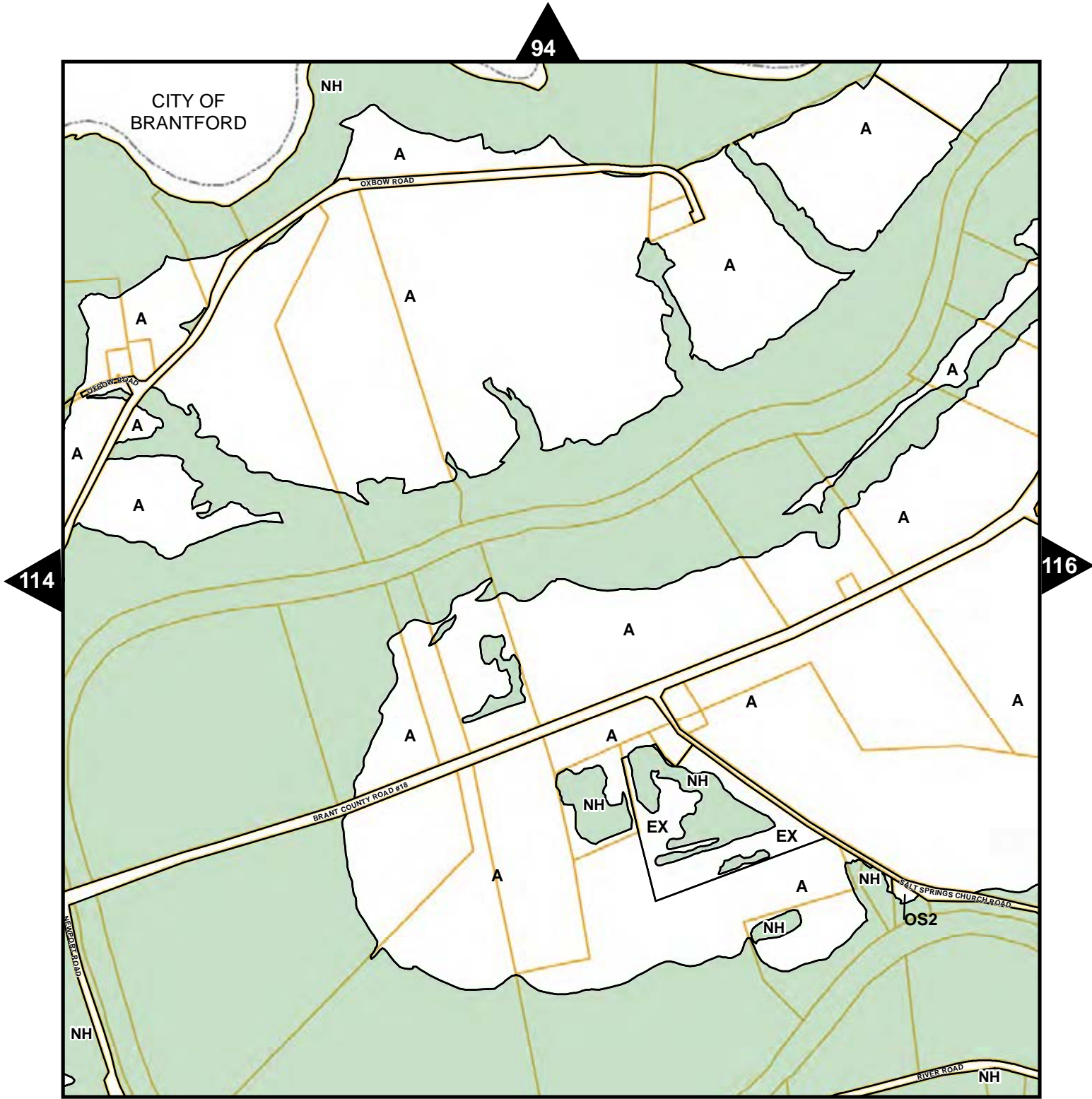

- Zoning
- Natural Heritage
- Parcel Fabric



ZONING BY-LAW SCHEDULE 'A' Map No. 115



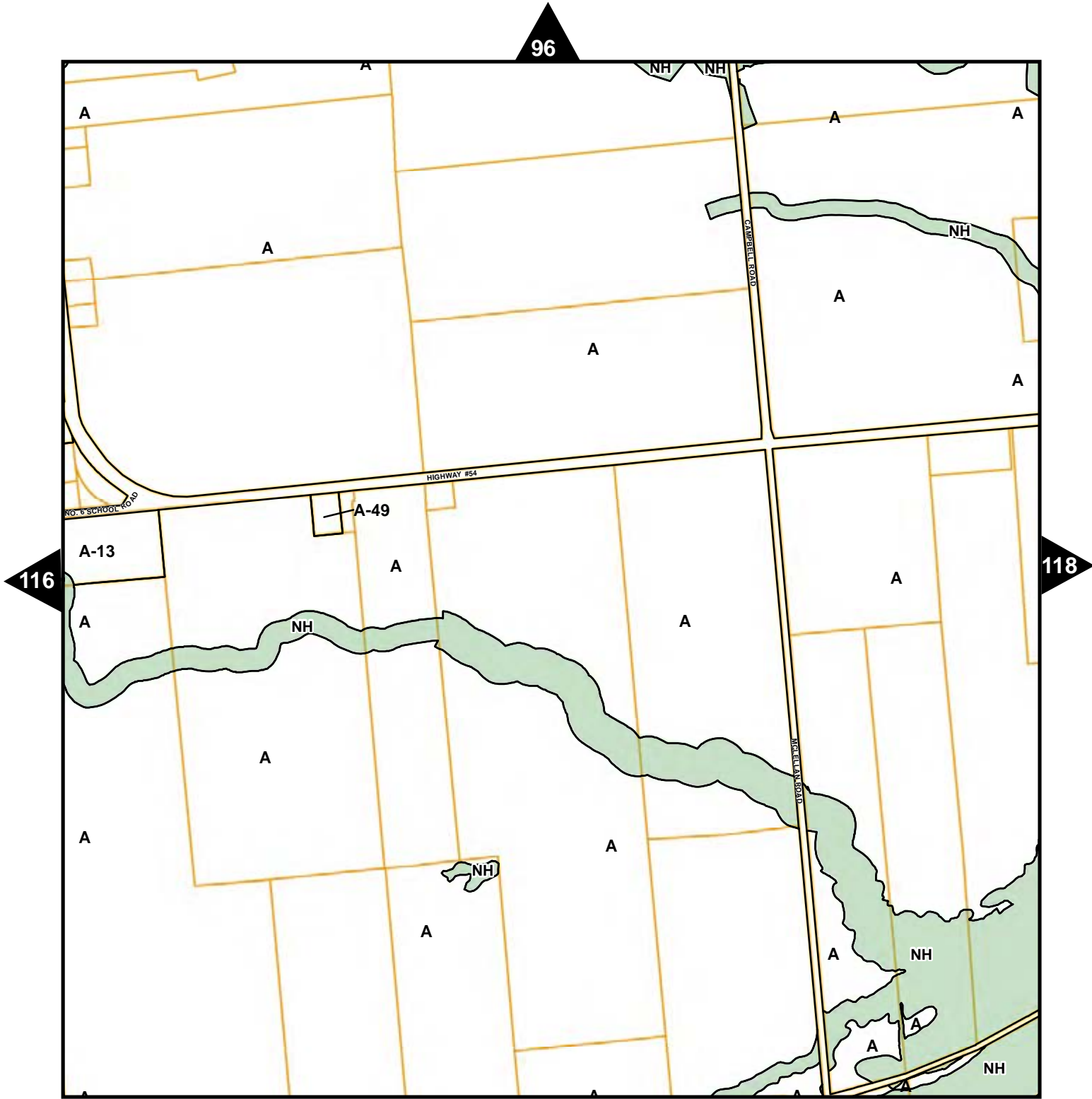

- Zoning
- Natural Heritage
- Parcel Fabric



ZONING BY-LAW
SCHEDULE 'A'
Map No. 117



97

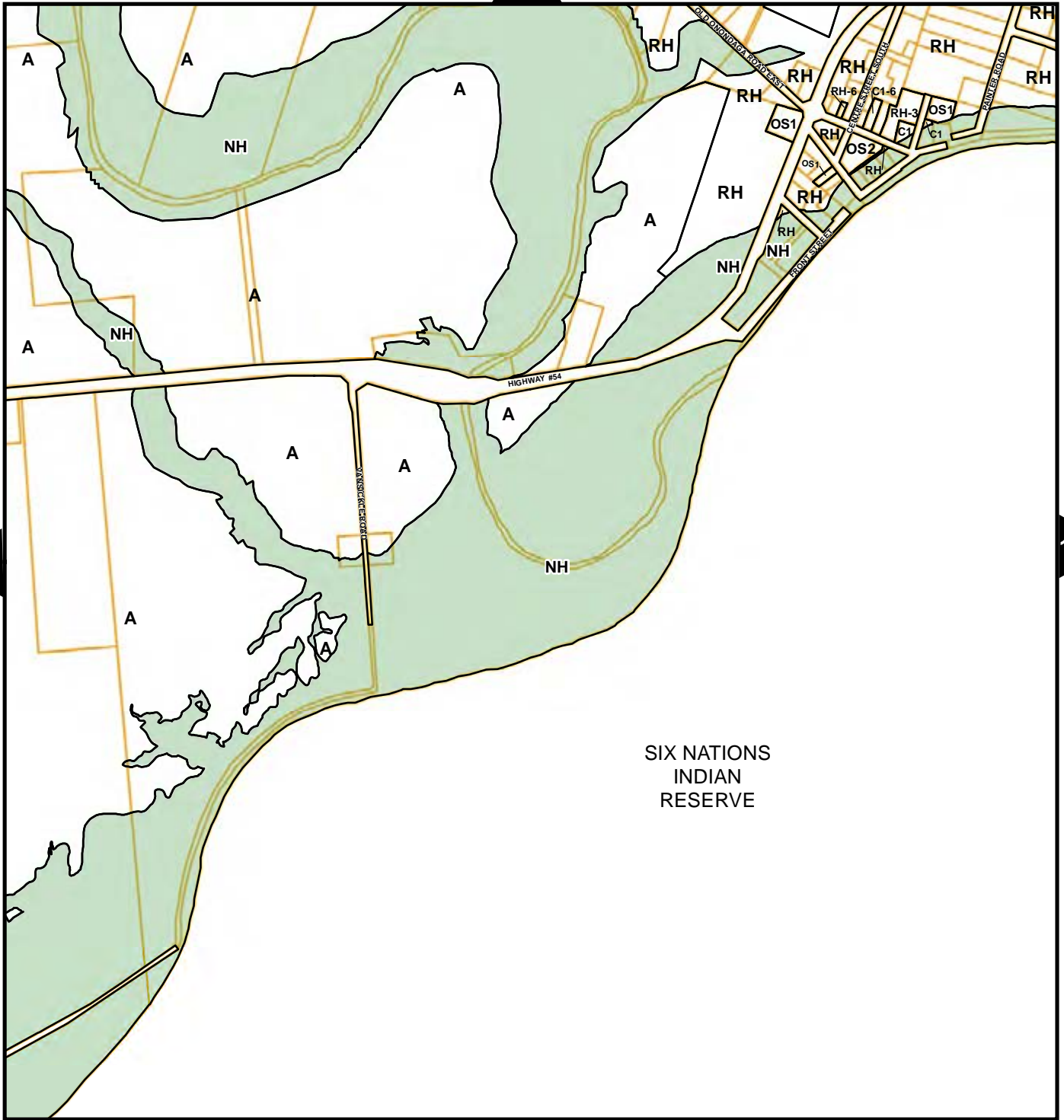



117

119

139



-  Zoning
-  Natural Heritage
-  Parcel Fabric

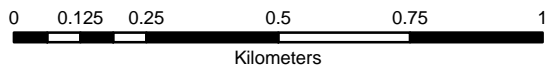

ZONING BY-LAW
SCHEDULE 'A'
Map No. 118



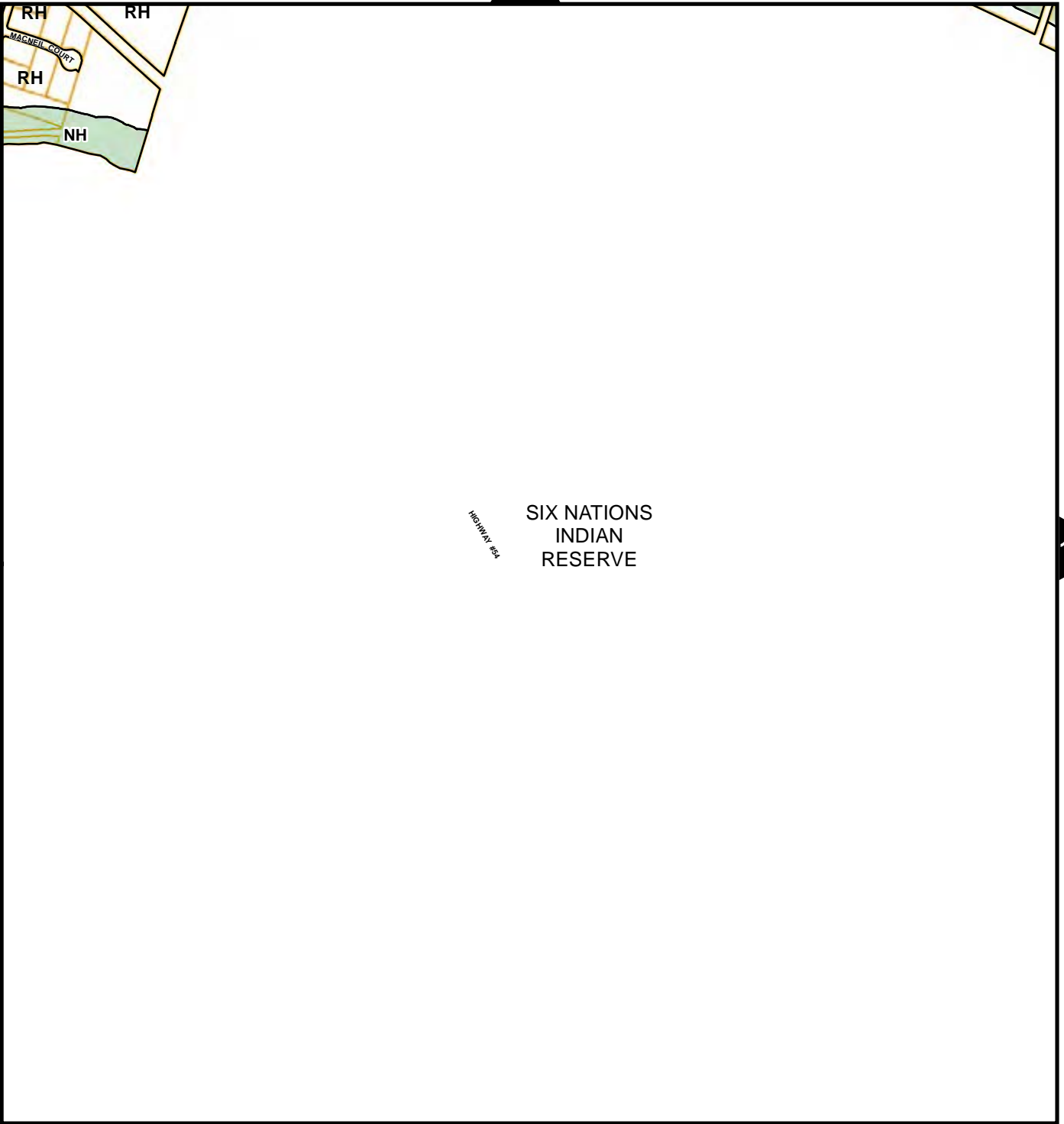

98



118

120





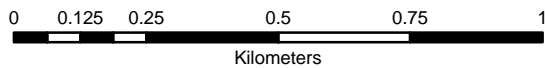

-  Zoning
-  Natural Heritage
-  Parcel Fabric

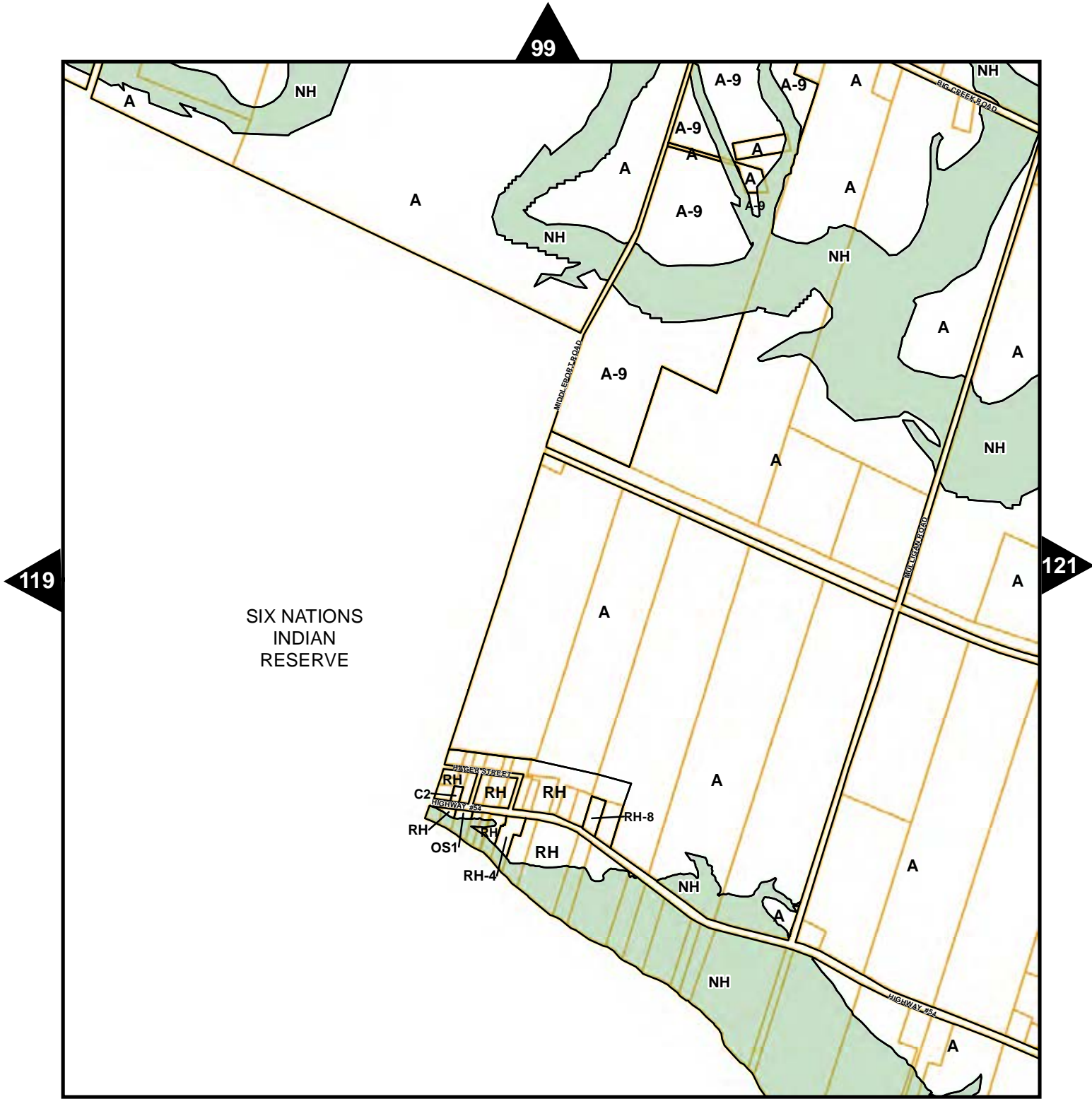

ZONING BY-LAW
SCHEDULE 'A'
Map No. 119





-  Zoning
-  Natural Heritage
-  Parcel Fabric



ZONING BY-LAW
SCHEDULE 'A'
Map No. 120



140

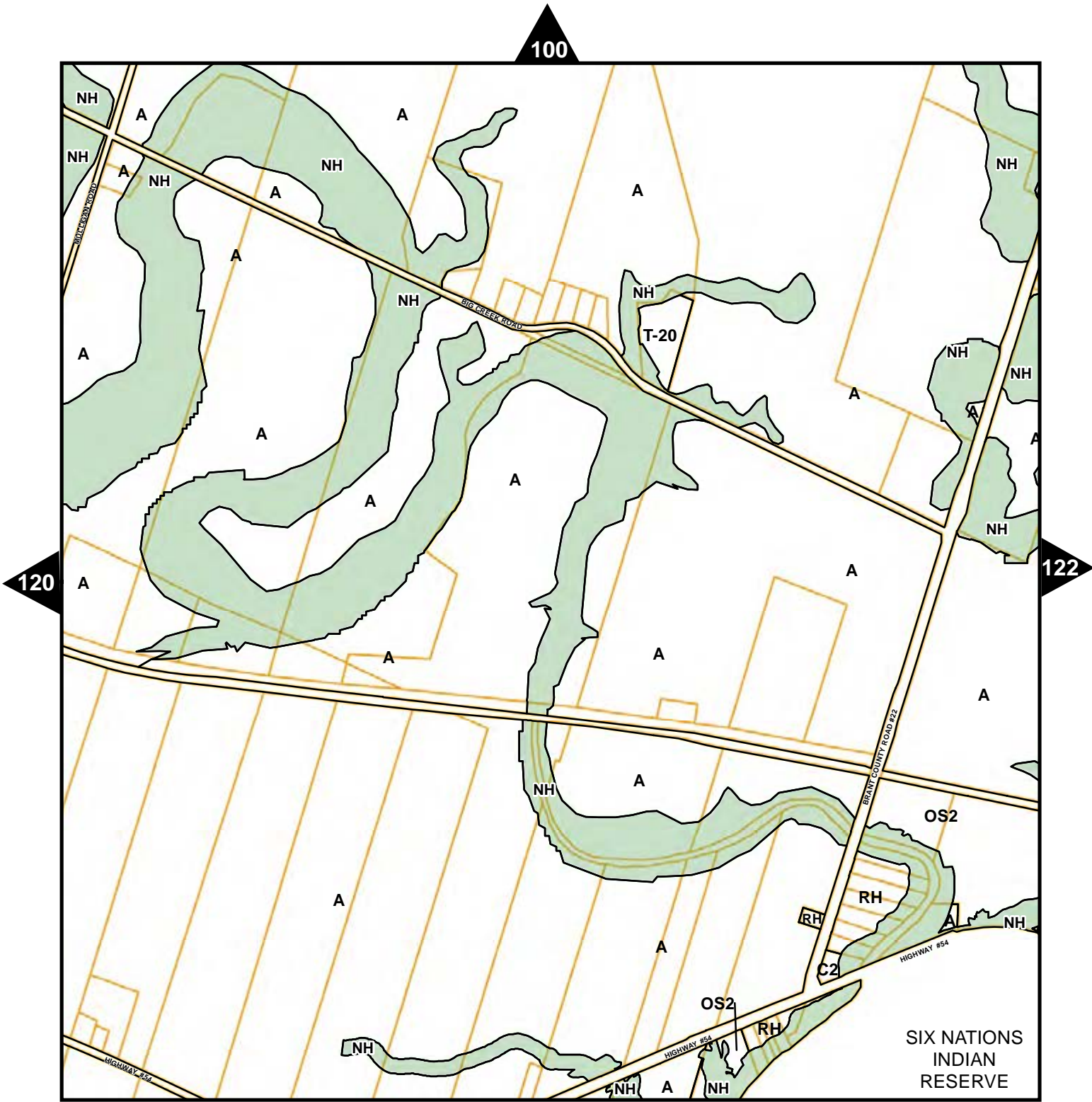

- Zoning
- Natural Heritage
- Parcel Fabric

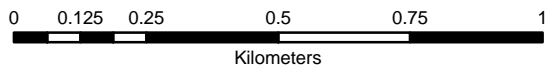

ZONING BY-LAW SCHEDULE 'A' Map No. 121



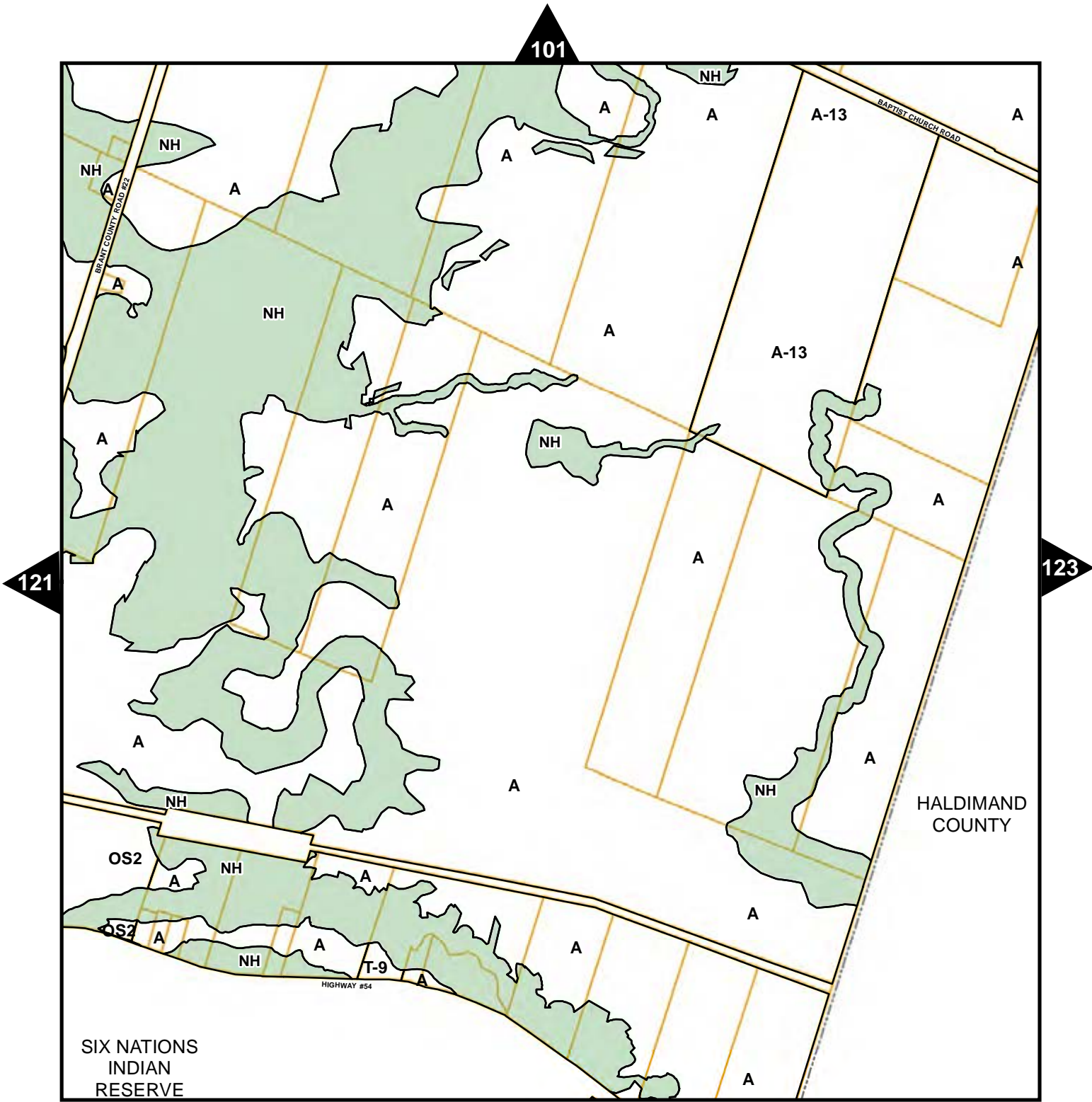

- Zoning
- Natural Heritage
- Parcel Fabric



ZONING BY-LAW SCHEDULE 'A' Map No. 122



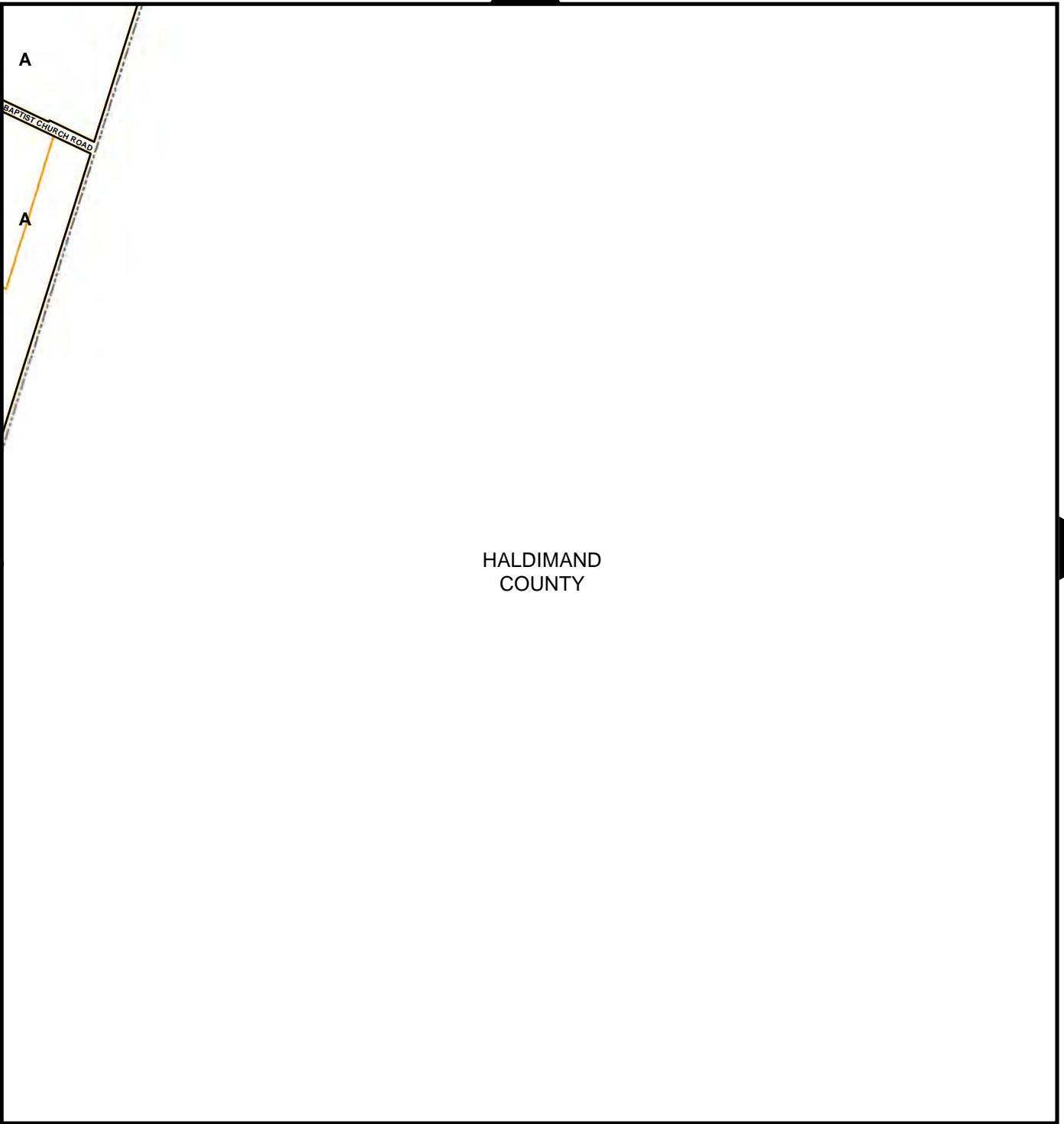

102



122

HALDIMAND COUNTY



-  Zoning
-  Natural Heritage
-  Parcel Fabric

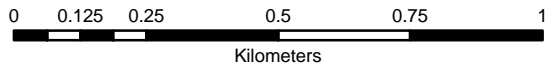

ZONING BY-LAW
SCHEDULE 'A'
Map No. 123



103

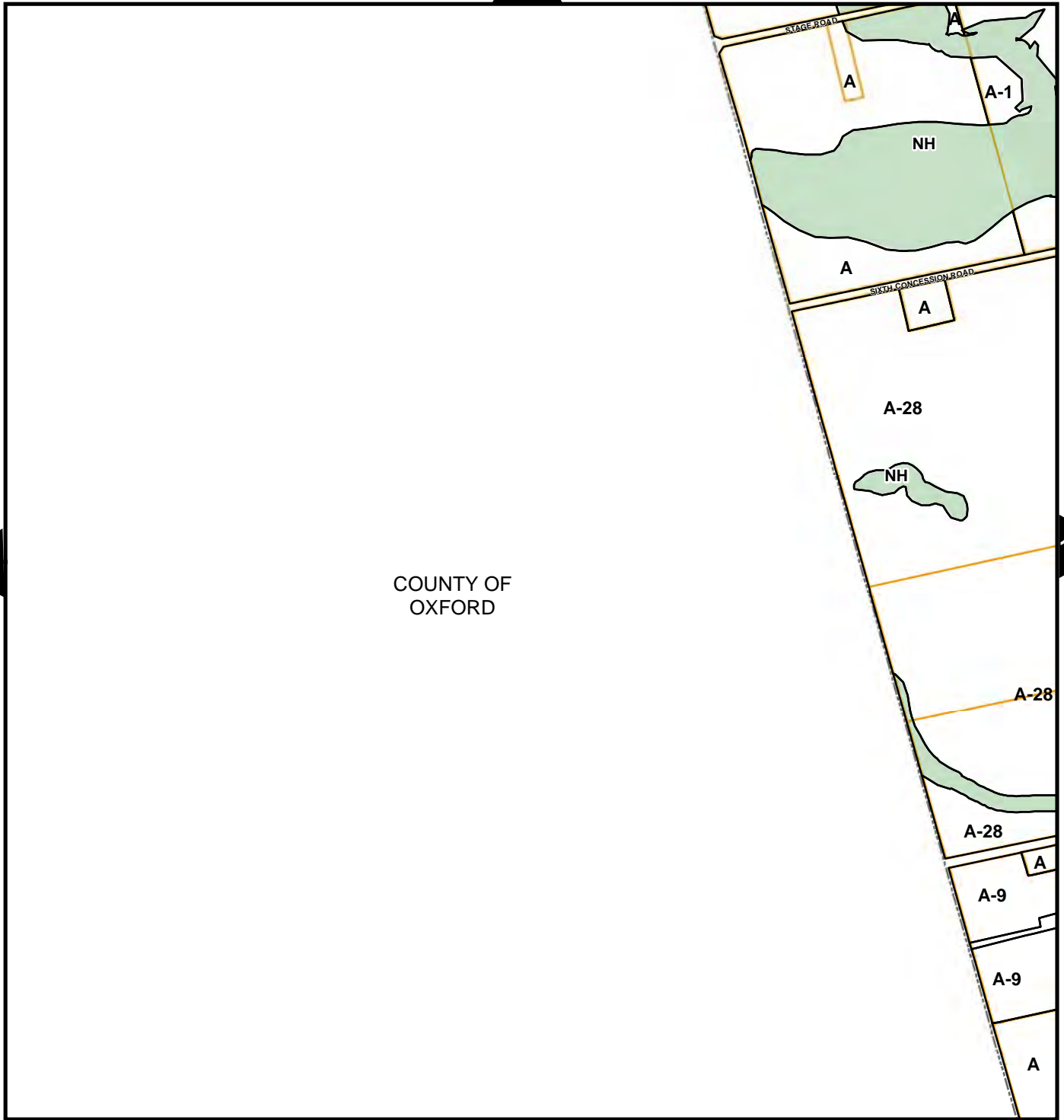



125

143



ZONING BY-LAW
SCHEDULE 'A'
Map No. 124

-  Zoning
-  Natural Heritage
-  Parcel Fabric

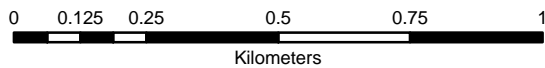

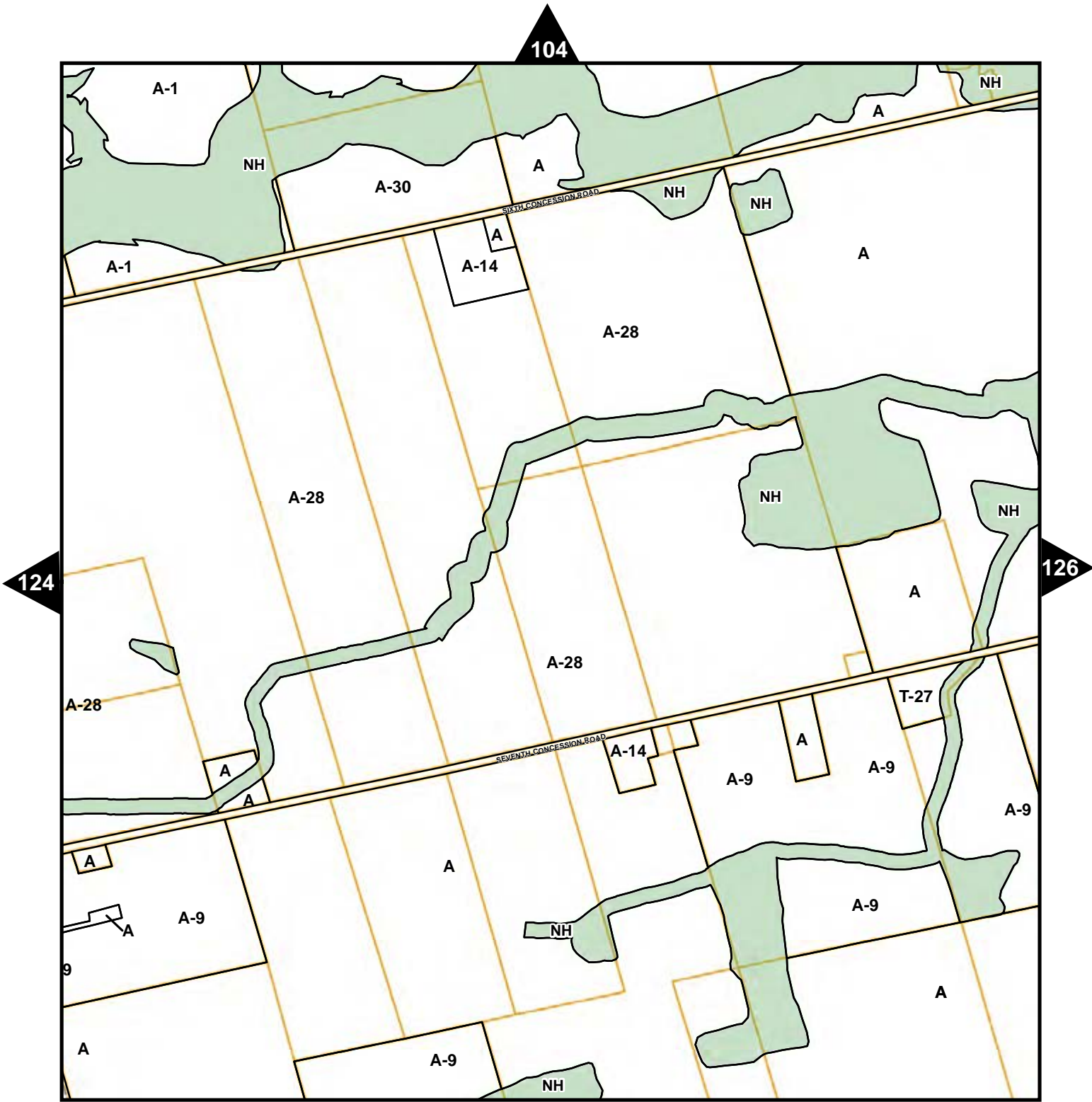

- Zoning
- Natural Heritage
- Parcel Fabric



ZONING BY-LAW SCHEDULE 'A' Map No. 125



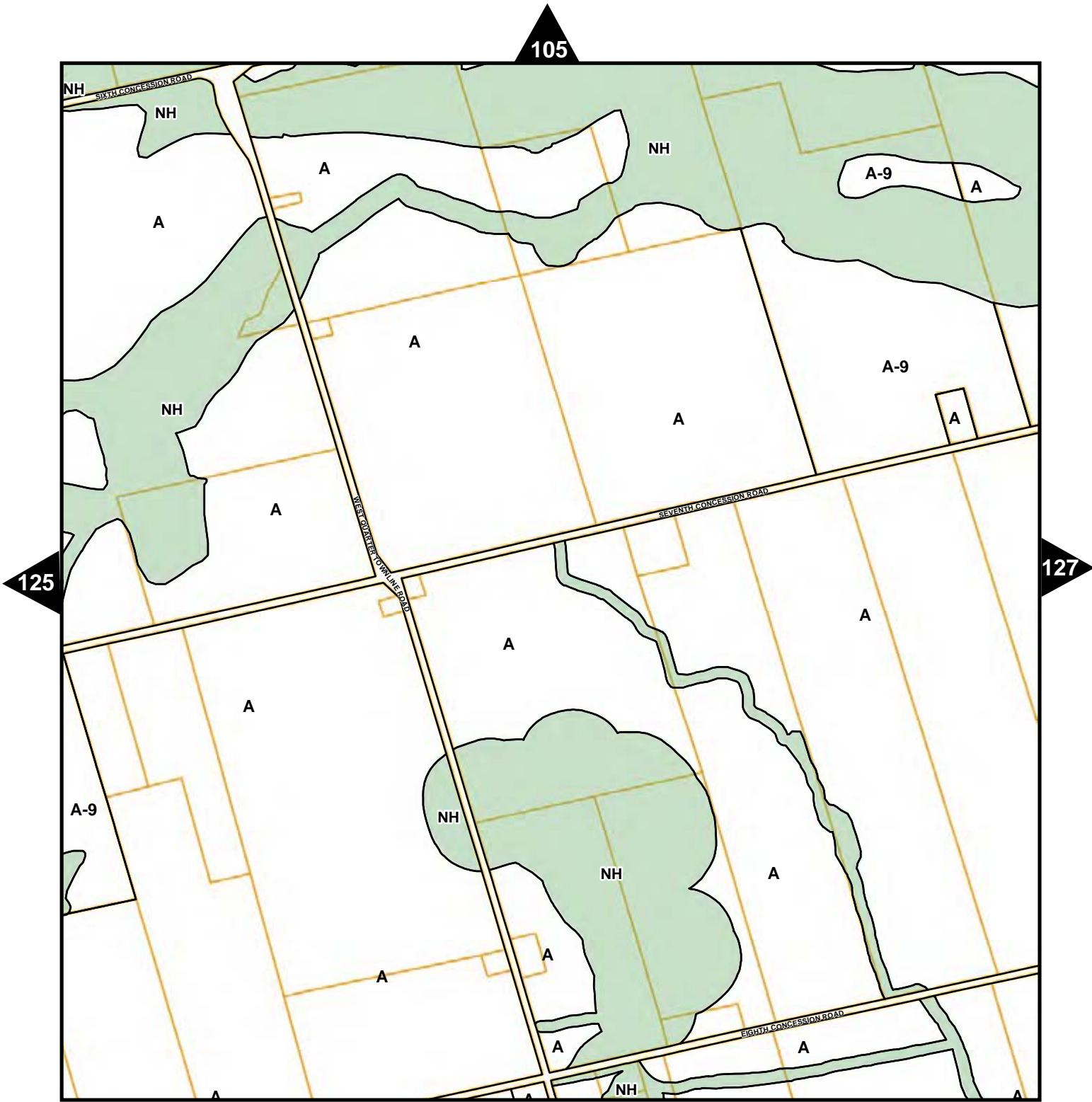

- Zoning
- Natural Heritage
- Parcel Fabric



ZONING BY-LAW SCHEDULE 'A' Map No. 126



106

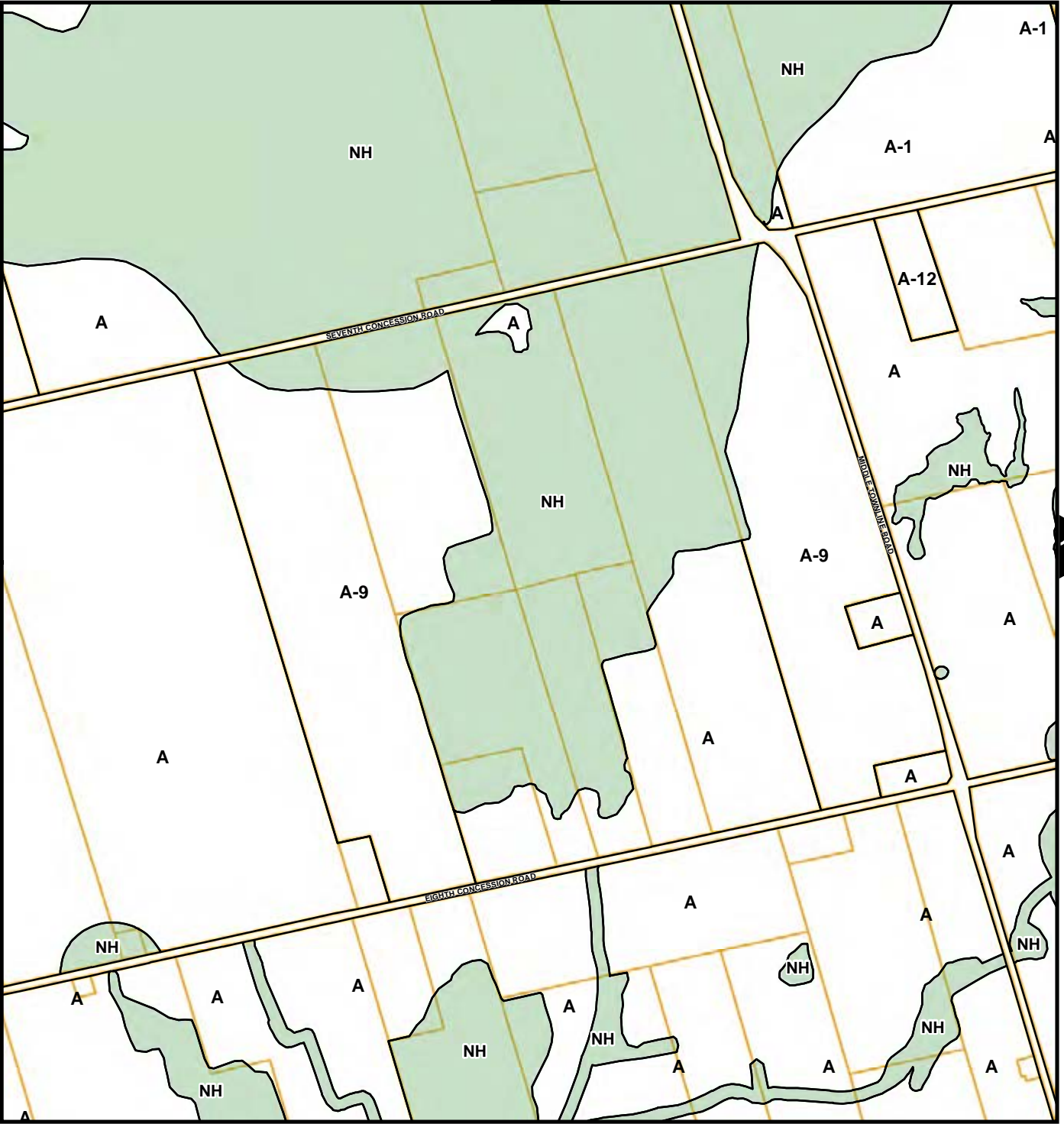



126

128

146



ZONING BY-LAW
SCHEDULE 'A'
Map No. 127

-  Zoning
-  Natural Heritage
-  Parcel Fabric

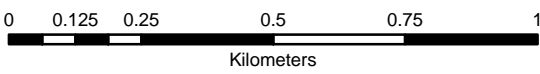

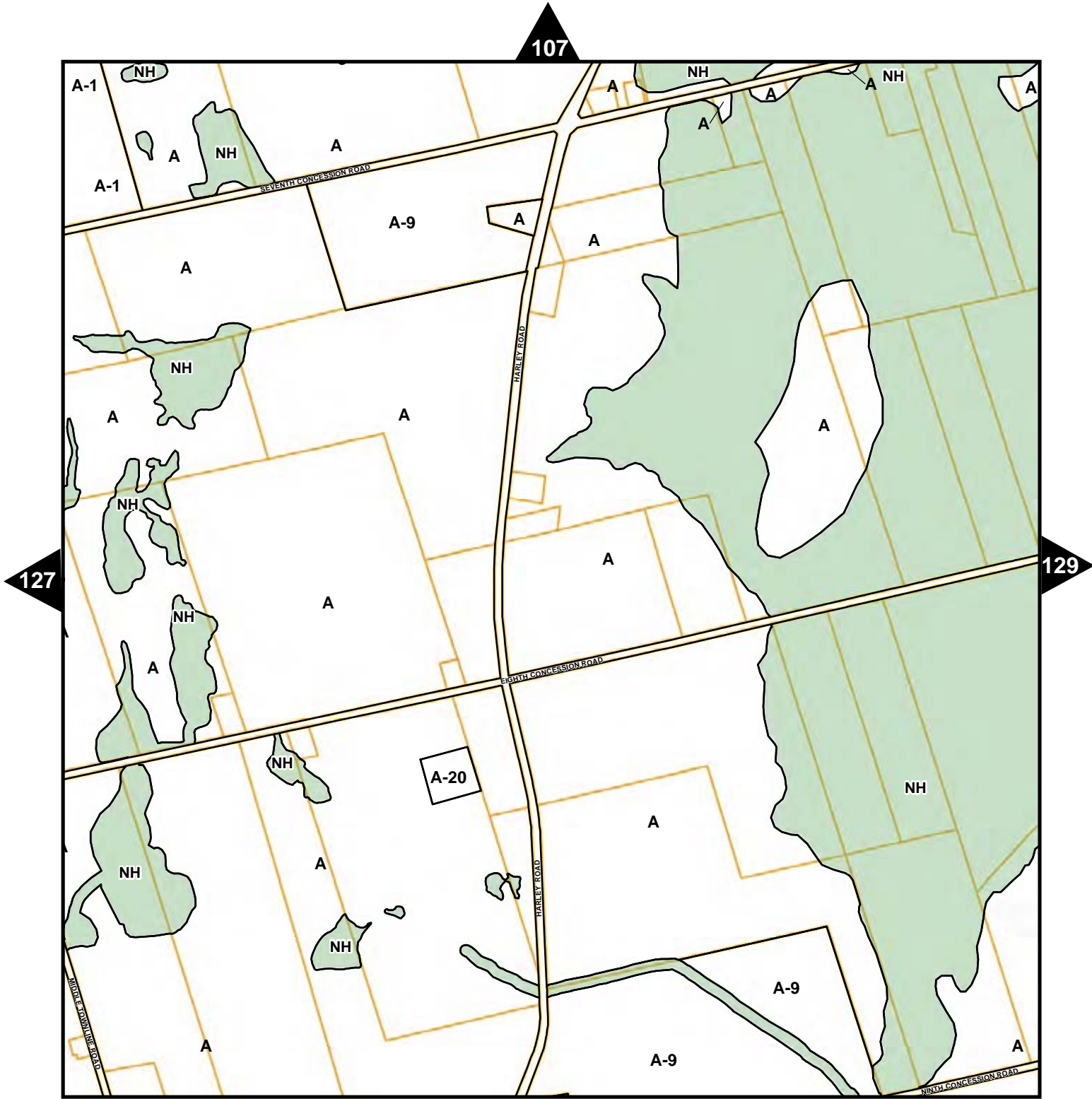

- Zoning
- Natural Heritage
- Parcel Fabric

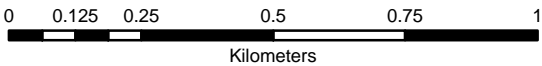

ZONING BY-LAW SCHEDULE 'A' Map No. 128



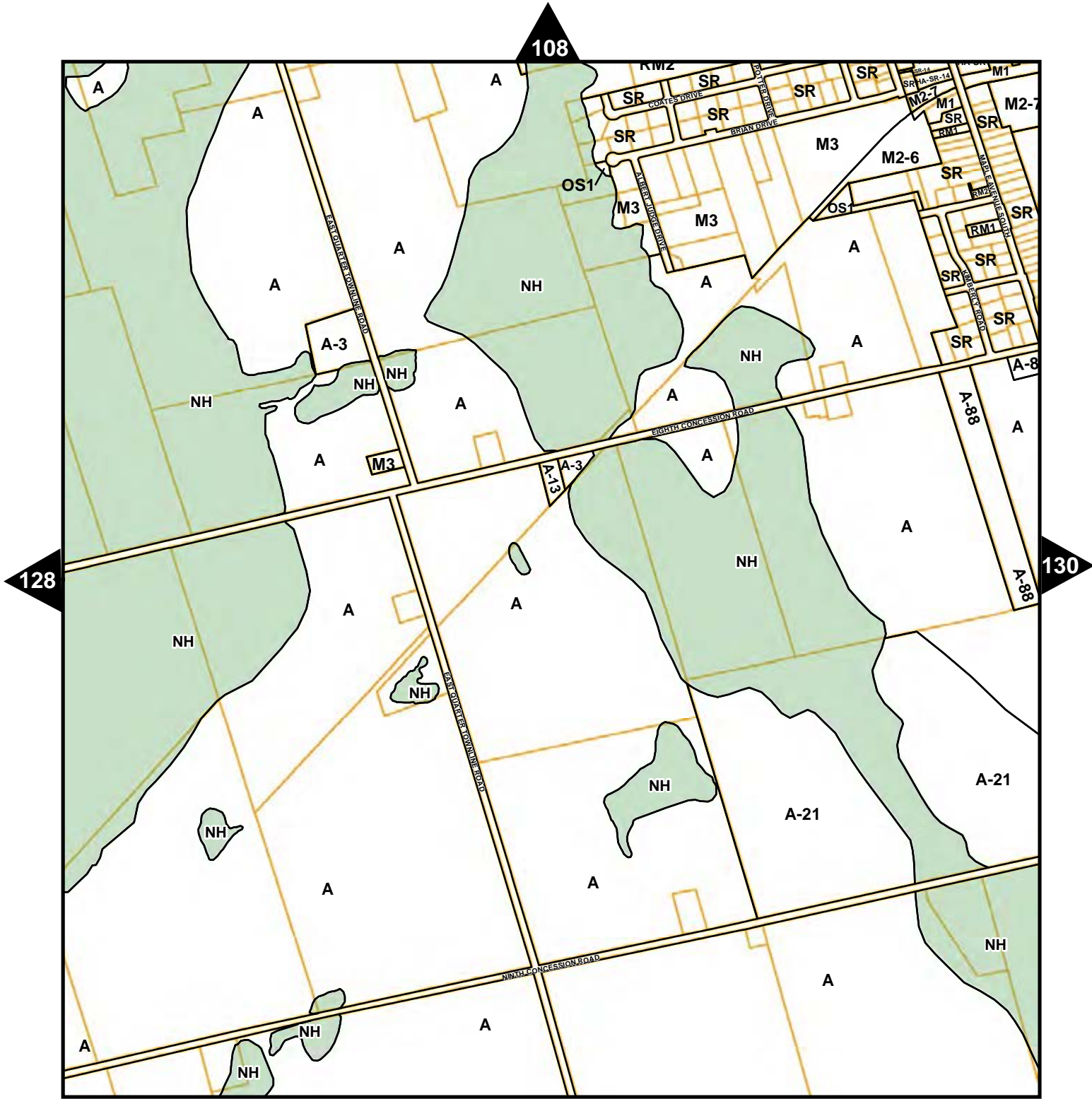

- Zoning
- Natural Heritage
- Parcel Fabric



ZONING BY-LAW SCHEDULE 'A' Map No. 129



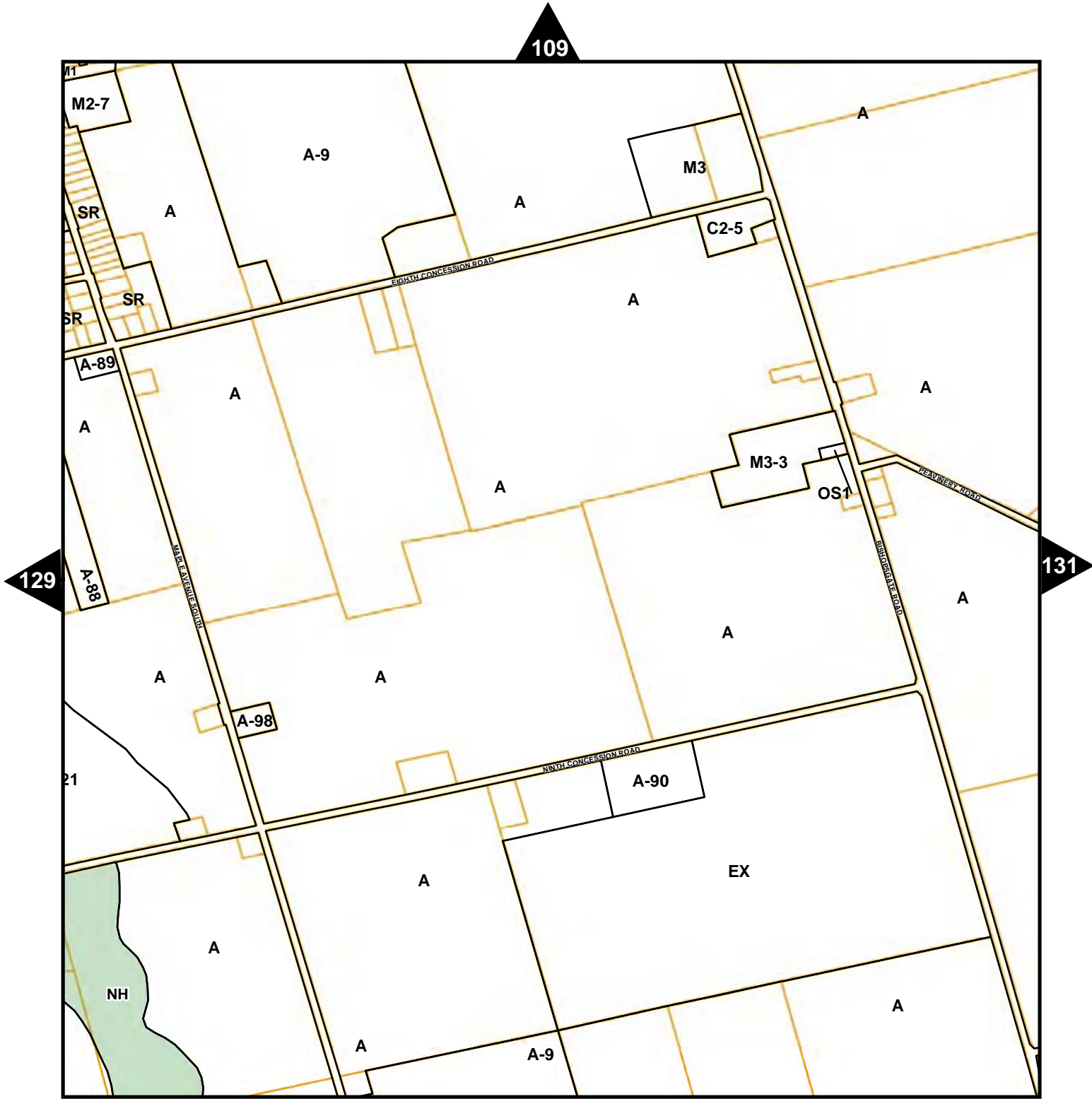

- Zoning
- Natural Heritage
- Parcel Fabric

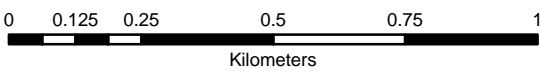

ZONING BY-LAW
SCHEDULE 'A'
Map No. 130







149

109

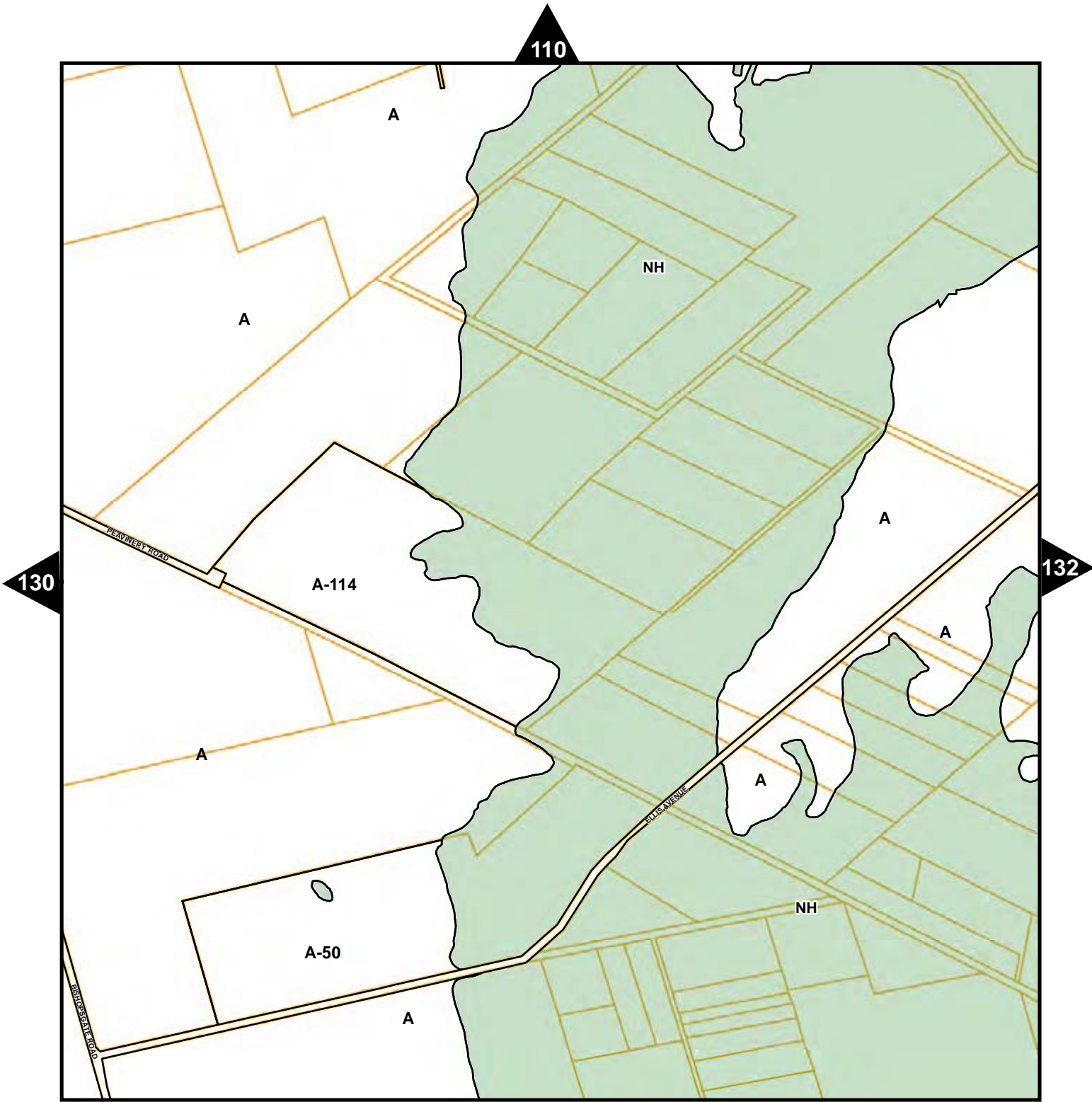
129

131







-  Zoning
-  Natural Heritage
-  Parcel Fabric

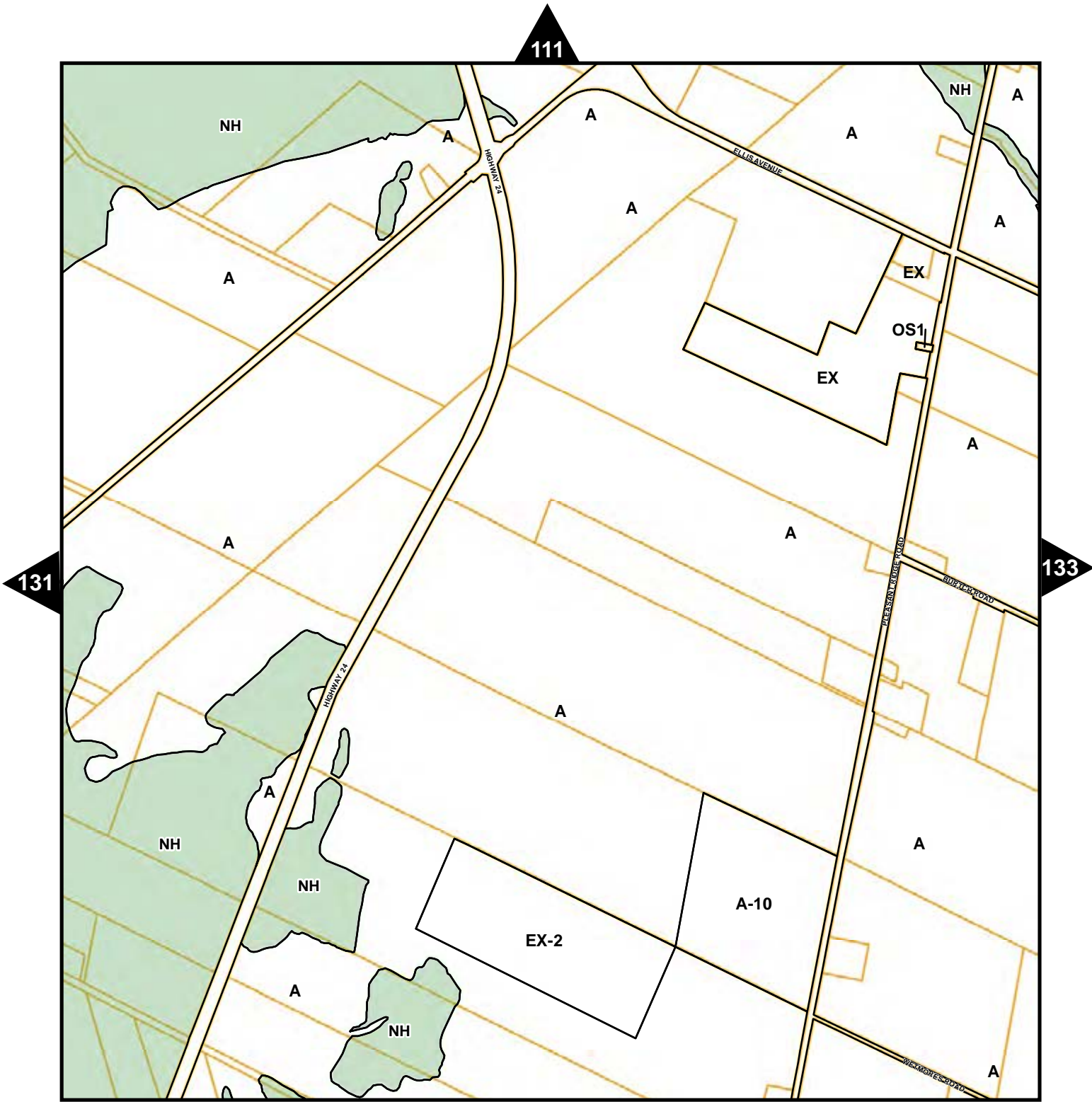

ZONING BY-LAW SCHEDULE 'A' Map No. 131





-  Zoning
-  Natural Heritage
-  Parcel Fabric



ZONING BY-LAW SCHEDULE 'A' Map No. 132



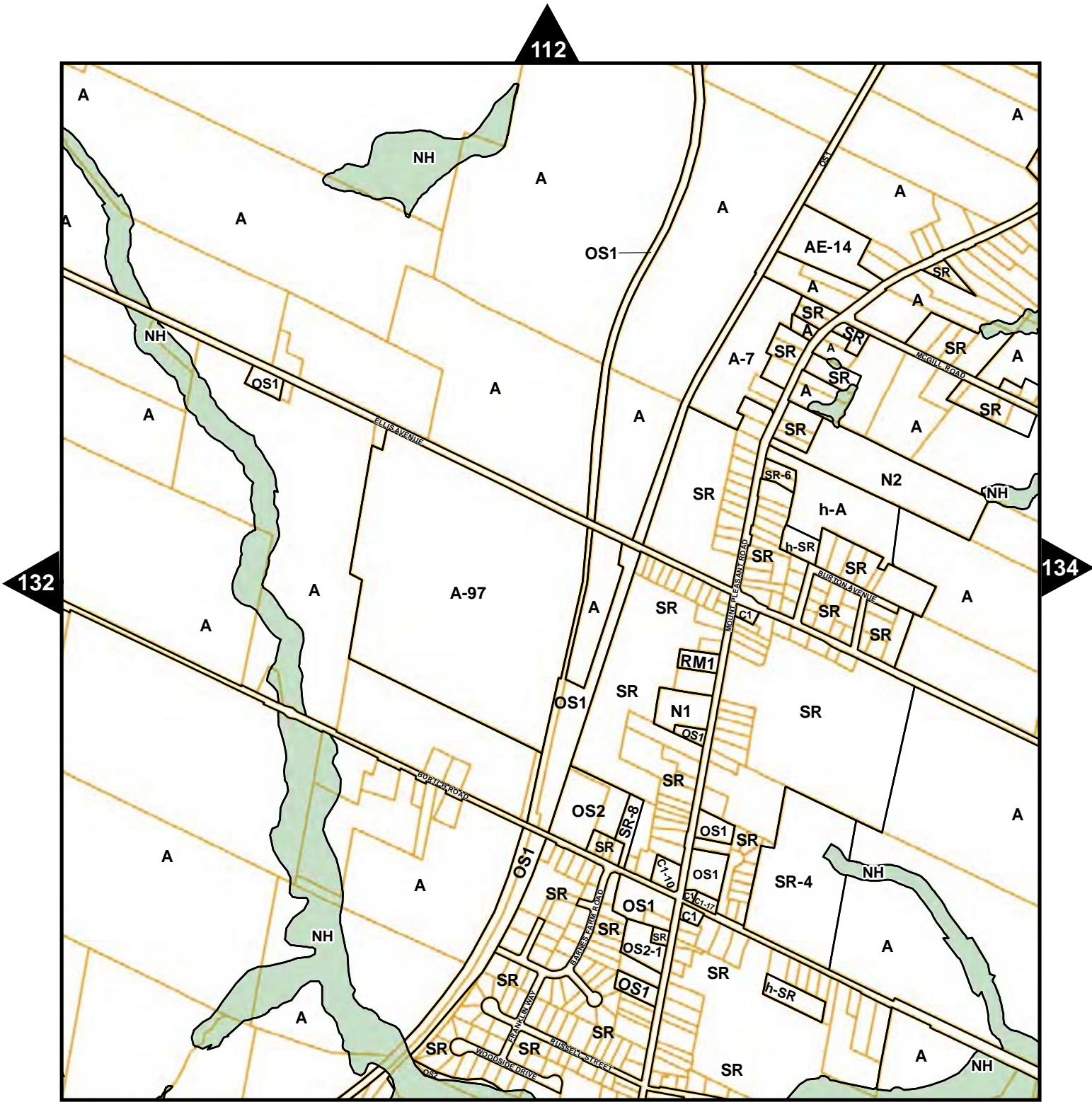

- Zoning
- Natural Heritage
- Parcel Fabric

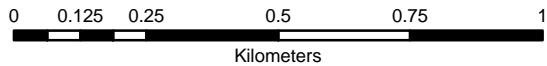

ZONING BY-LAW SCHEDULE 'A' Map No. 133



113

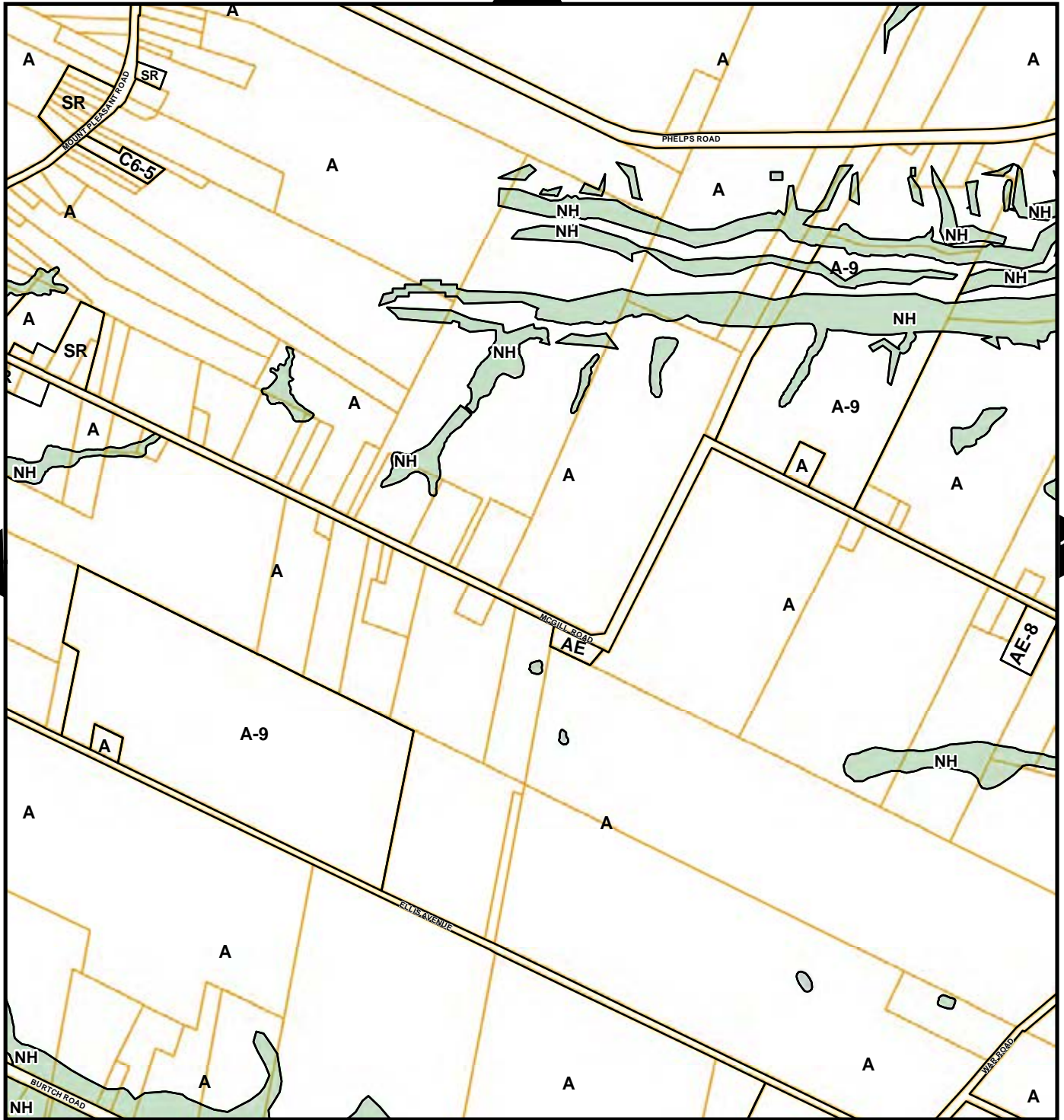

133

135

153





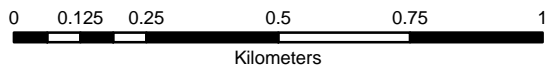

- Zoning
- Natural Heritage
- Parcel Fabric

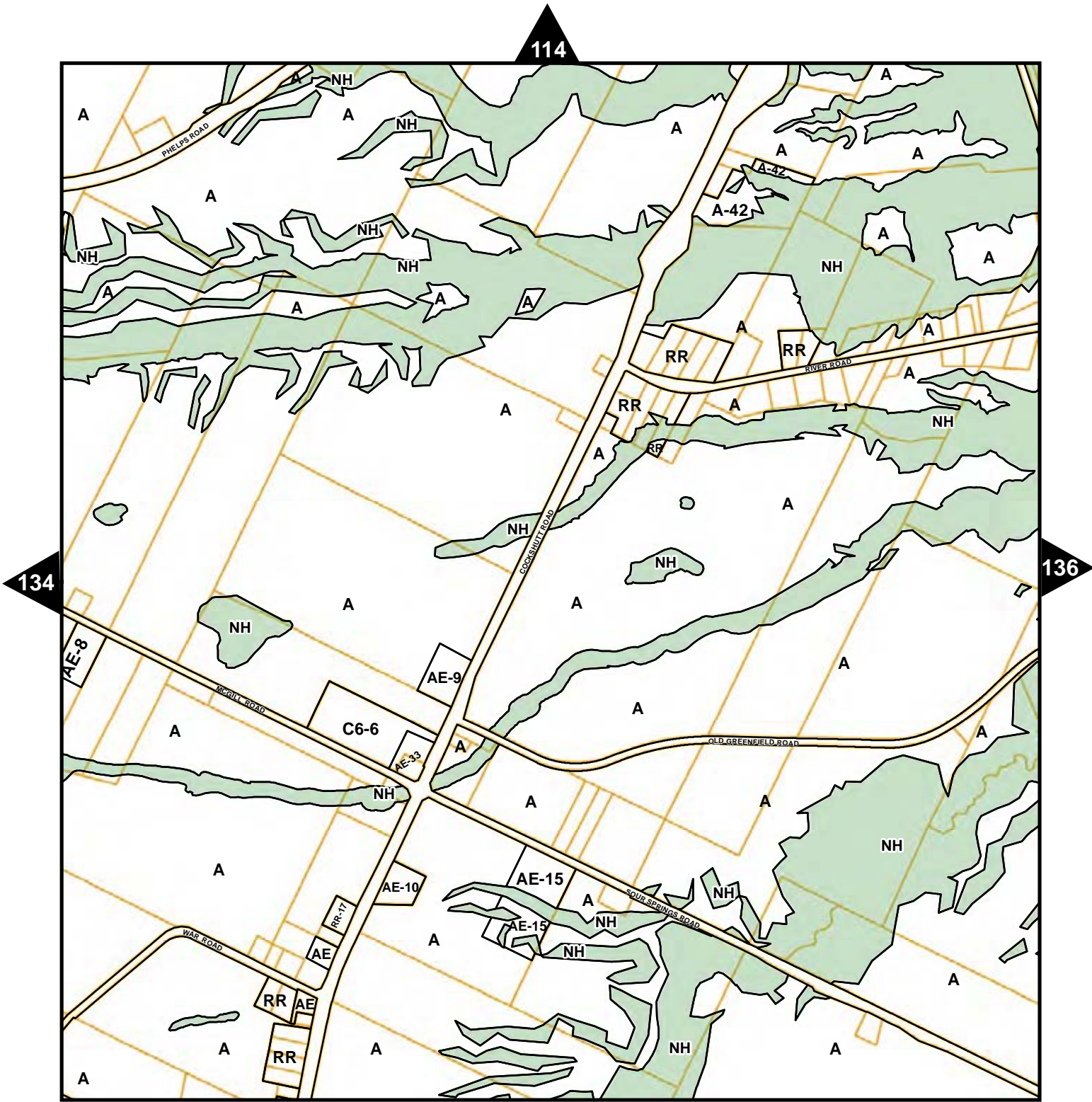

ZONING BY-LAW SCHEDULE 'A' Map No. 134





-  Zoning
-  Natural Heritage
-  Parcel Fabric



ZONING BY-LAW SCHEDULE 'A' Map No. 135



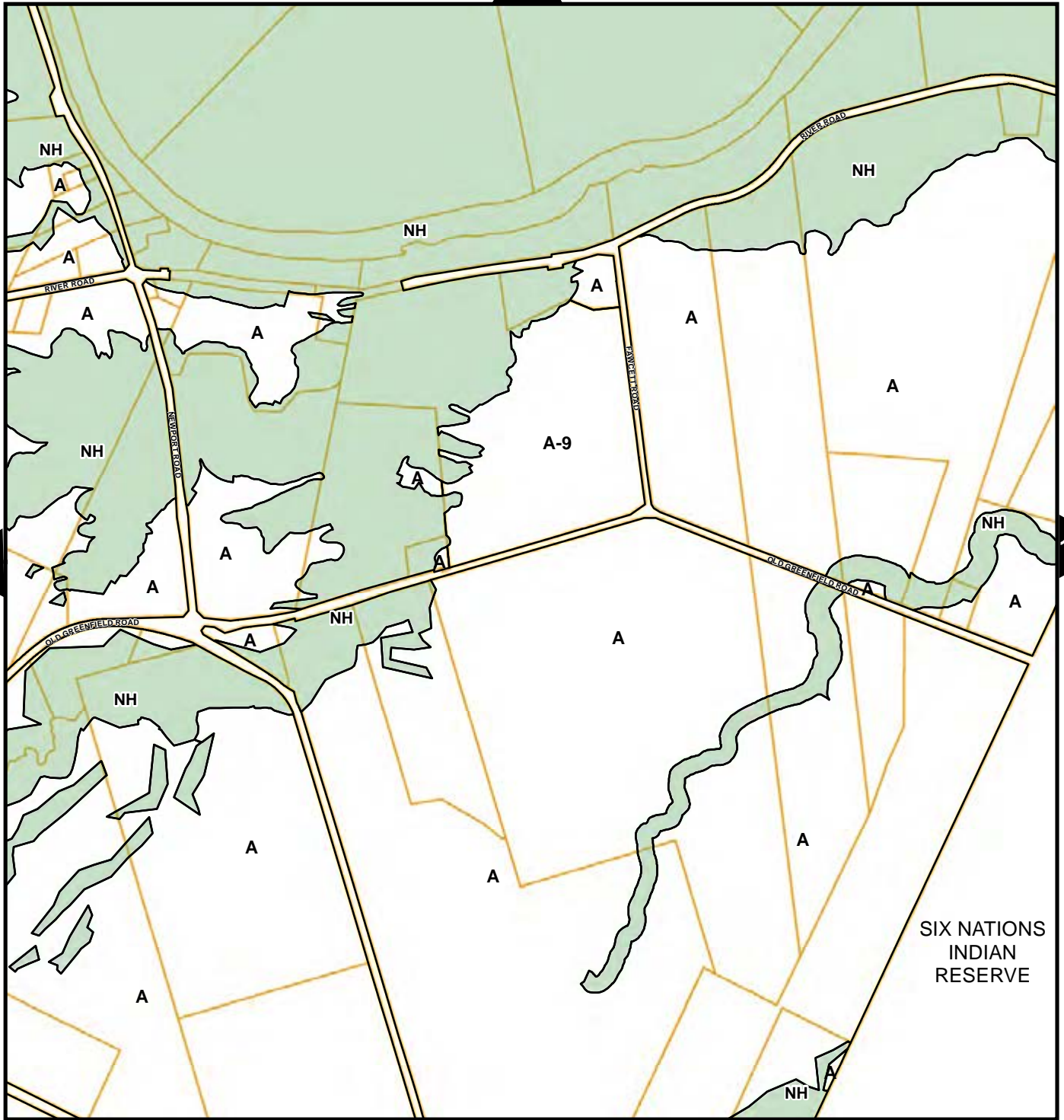

115



155



-  Zoning
-  Natural Heritage
-  Parcel Fabric

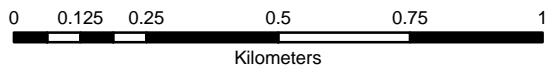

ZONING BY-LAW
SCHEDULE 'A'
Map No. 136



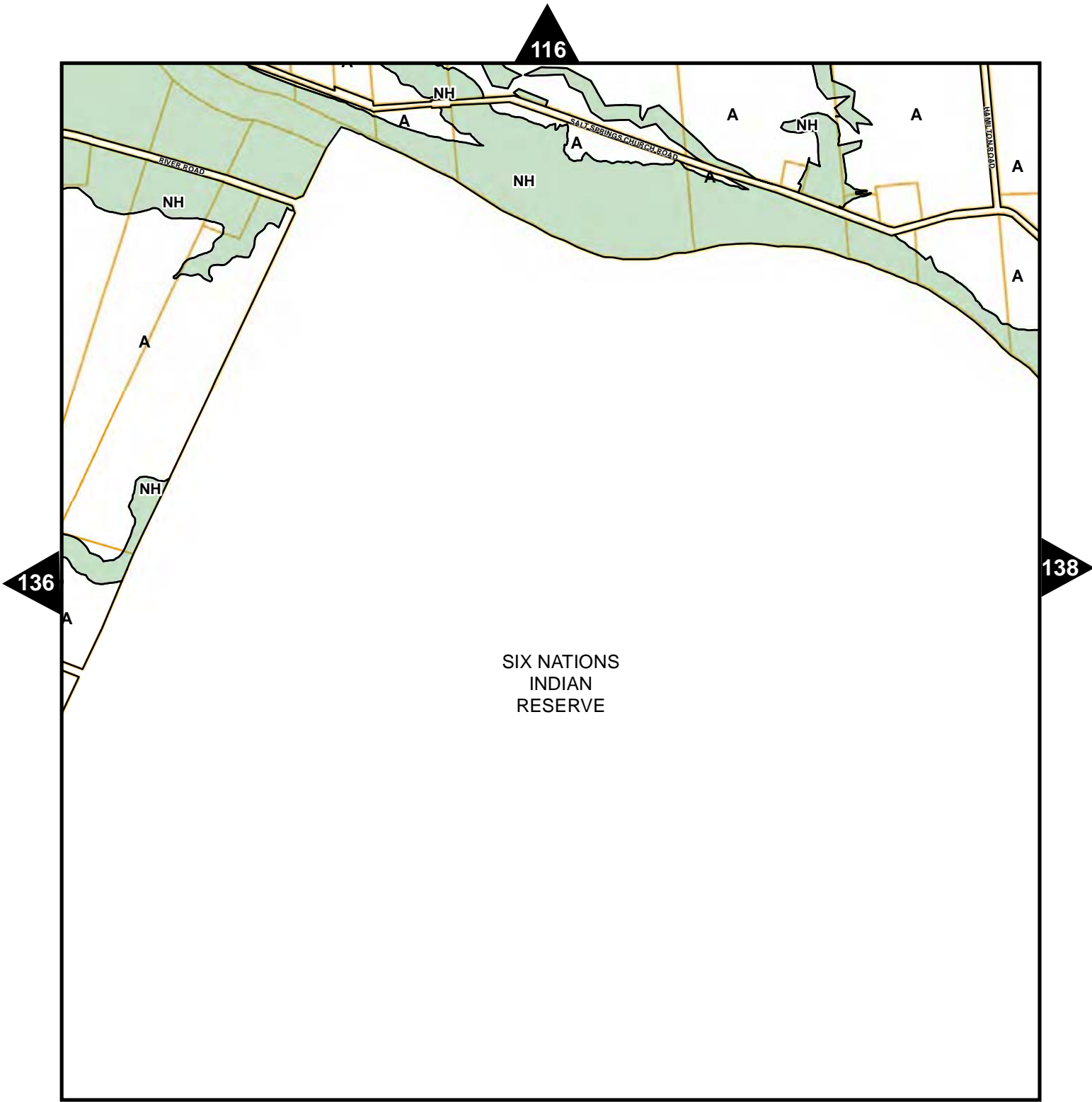

SIX NATIONS
INDIAN
RESERVE



- Zoning
- Natural Heritage
- Parcel Fabric

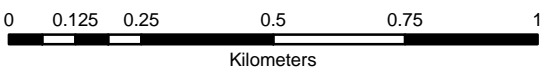

ZONING BY-LAW
SCHEDULE 'A'
Map No. 137



117

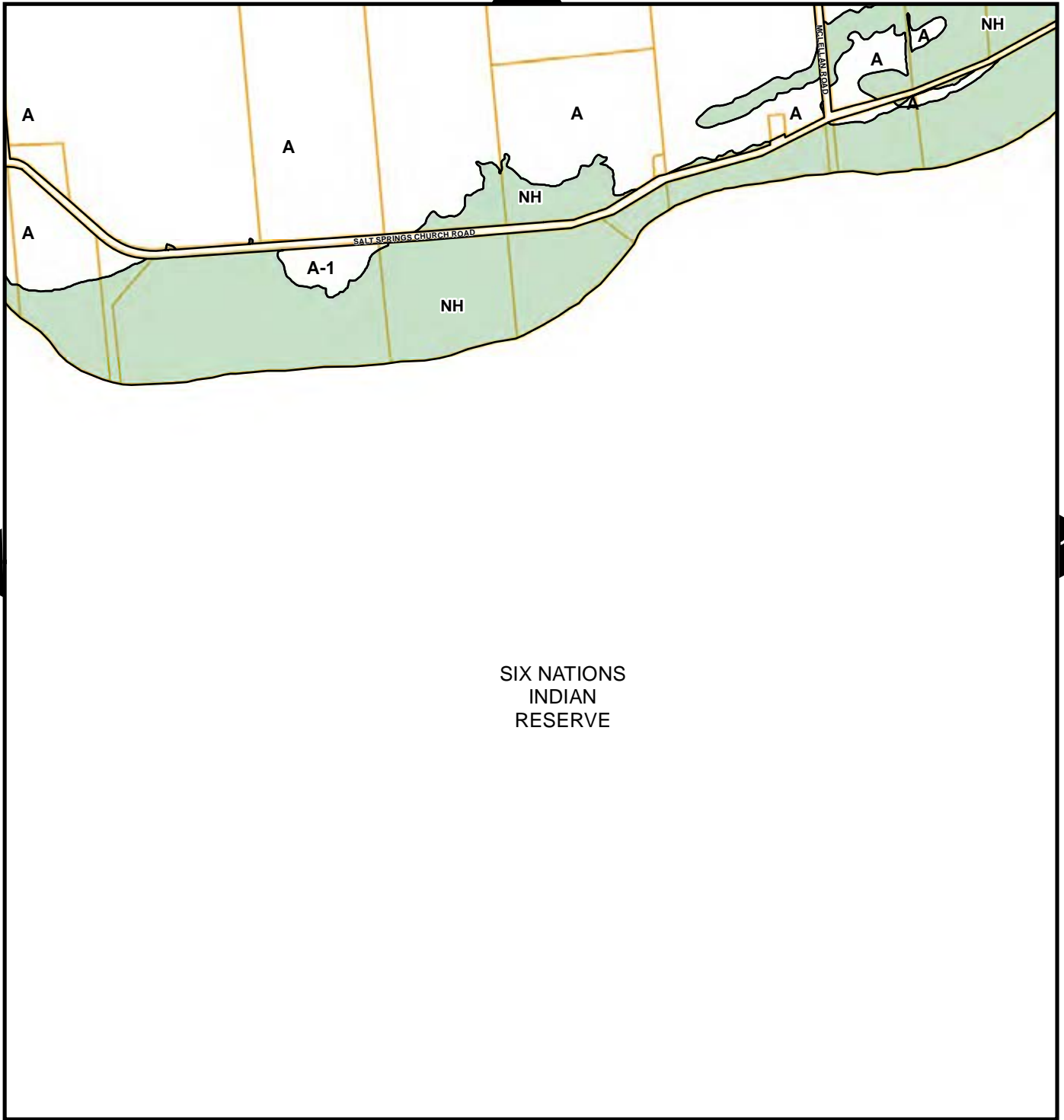



SIX NATIONS INDIAN RESERVE

137

139



-  Zoning
-  Natural Heritage
-  Parcel Fabric

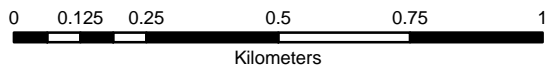

ZONING BY-LAW
SCHEDULE 'A'
Map No. 138





118

NH
NH

SIX NATIONS
INDIAN
RESERVE

138



-  Zoning
-  Natural Heritage
-  Parcel Fabric

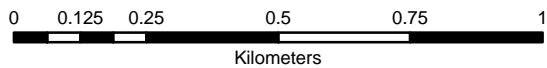

ZONING BY-LAW
SCHEDULE 'A'
Map No. 139



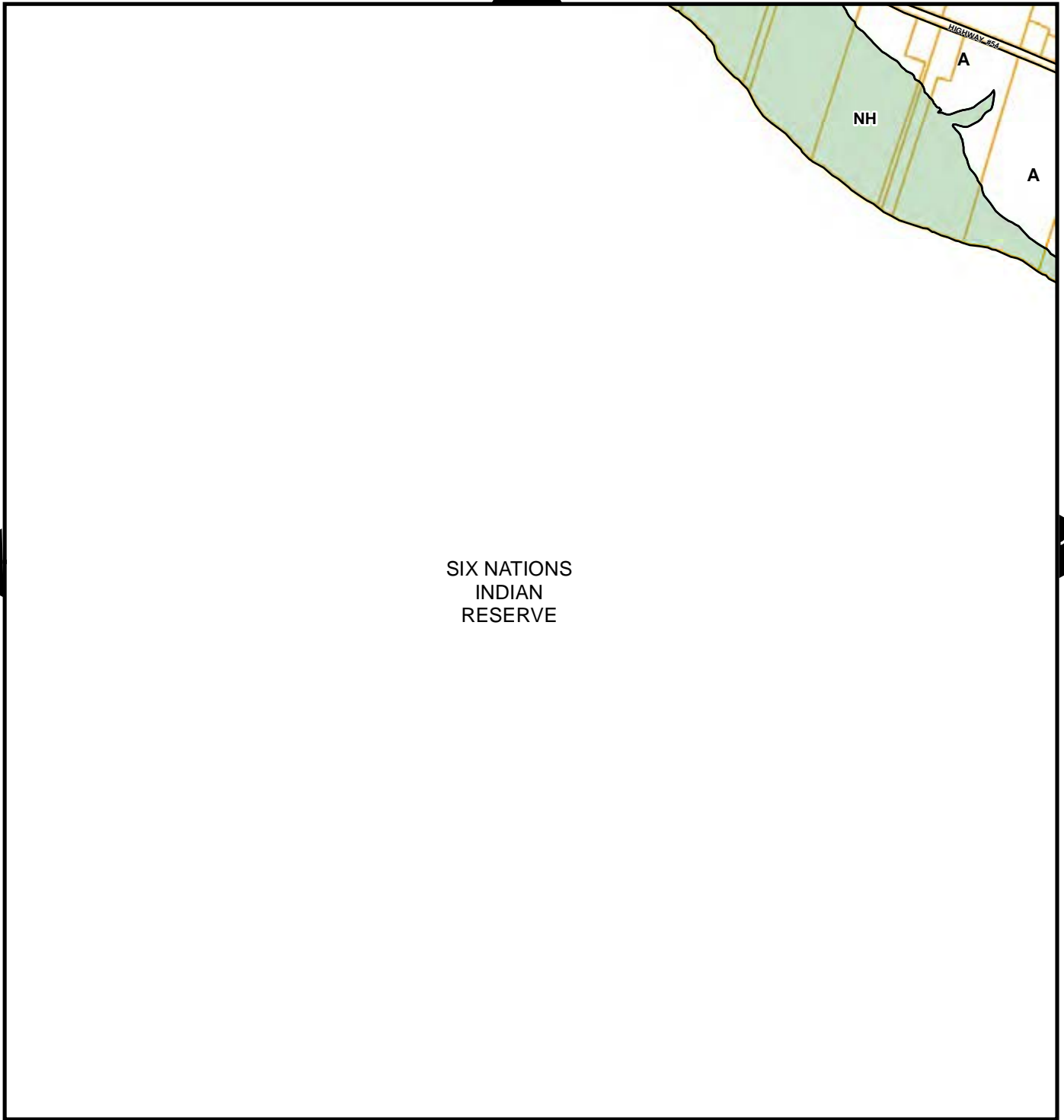

120



141



-  Zoning
-  Natural Heritage
-  Parcel Fabric

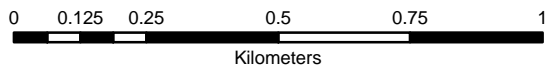

ZONING BY-LAW
SCHEDULE 'A'
Map No. 140



121

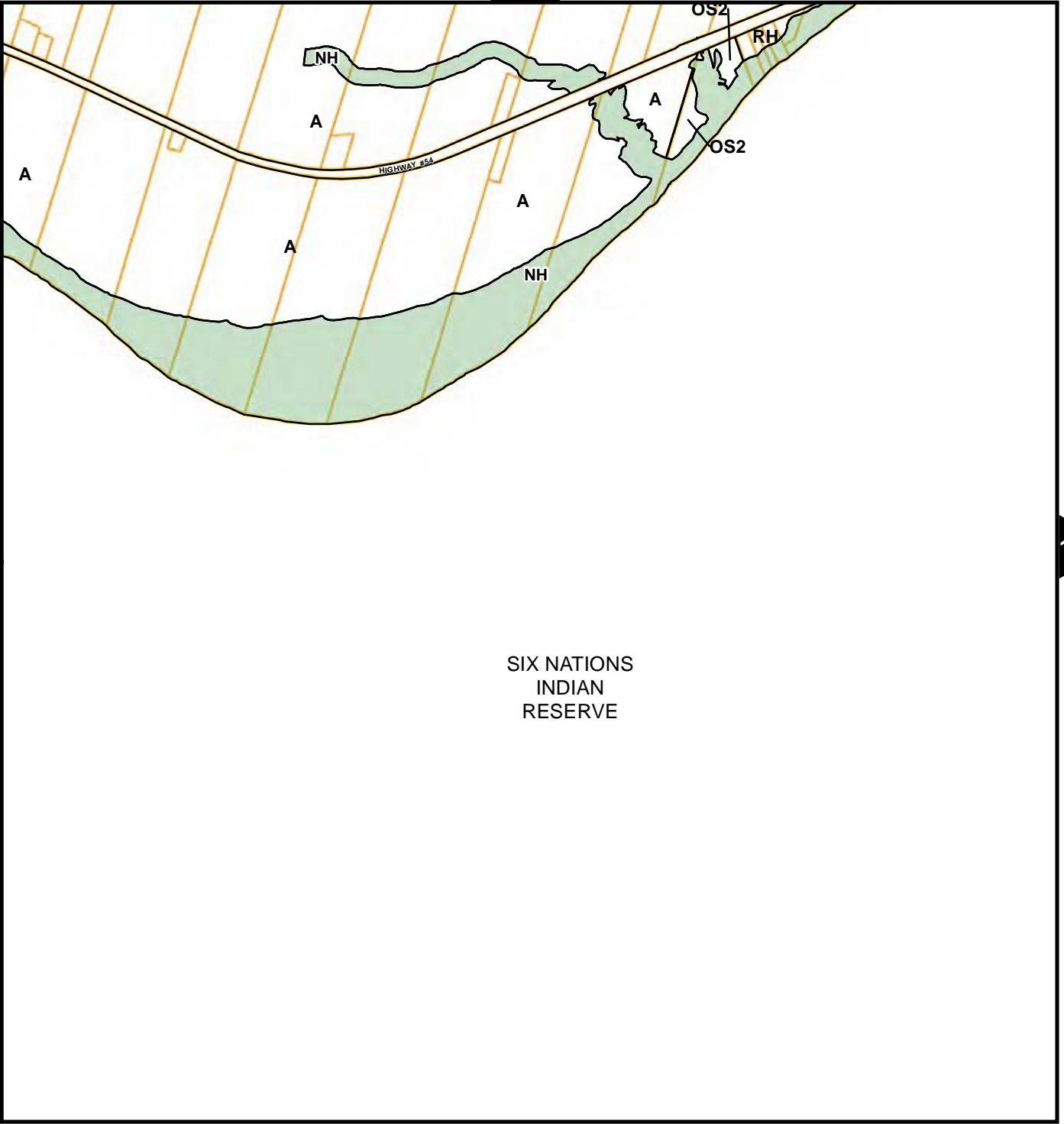

SIX NATIONS INDIAN RESERVE





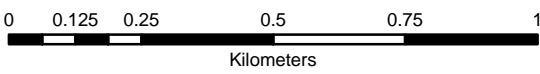

- Zoning
- Natural Heritage
- Parcel Fabric

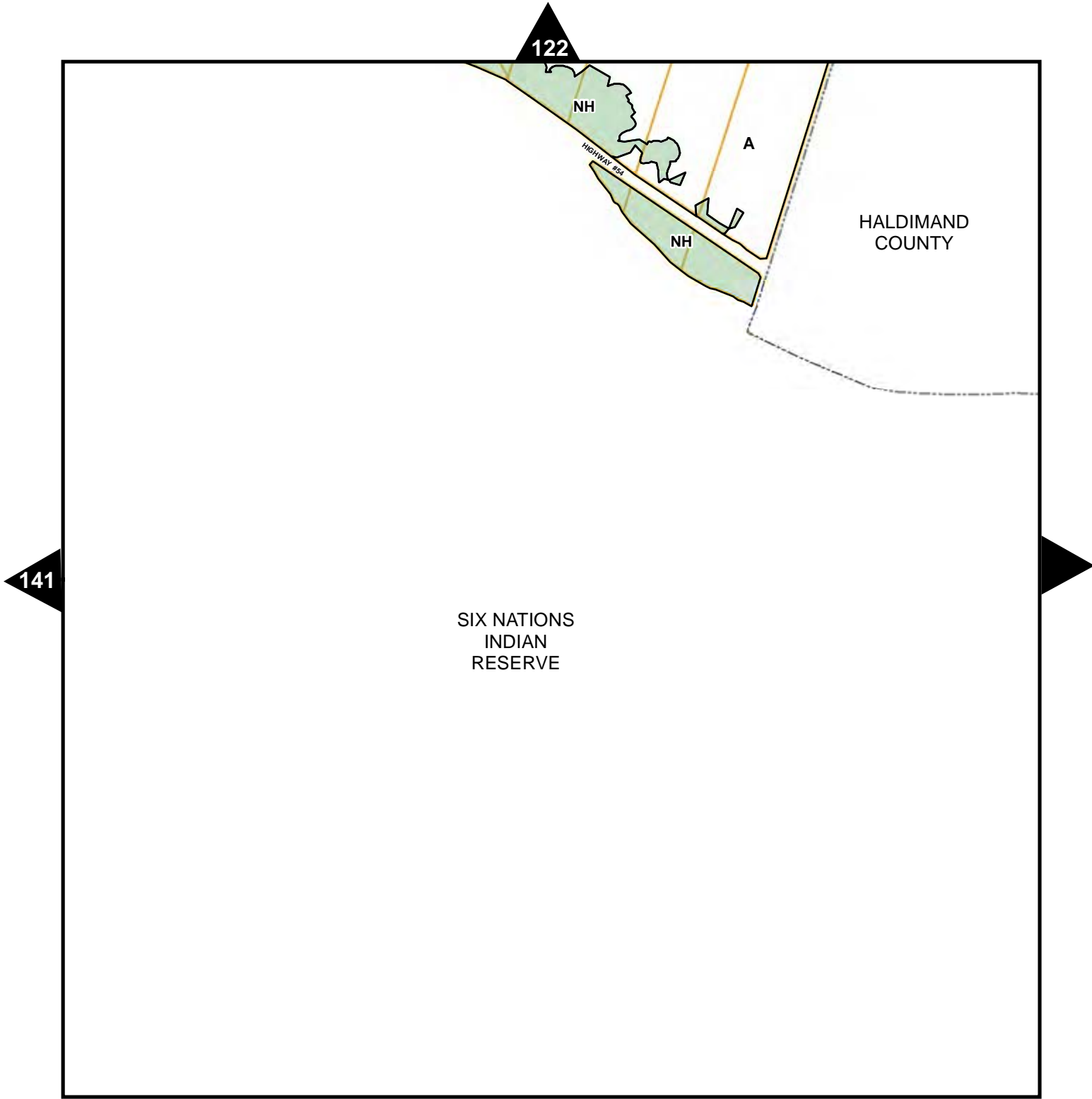

ZONING BY-LAW
SCHEDULE 'A'
Map No. 141





-  Zoning
-  Natural Heritage
-  Parcel Fabric

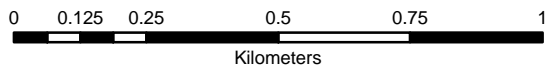

ZONING BY-LAW
SCHEDULE 'A'
Map No. 142





124

A

COUNTY OF OXFORD

144





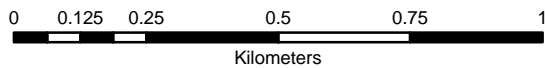

-  Zoning
-  Natural Heritage
-  Parcel Fabric

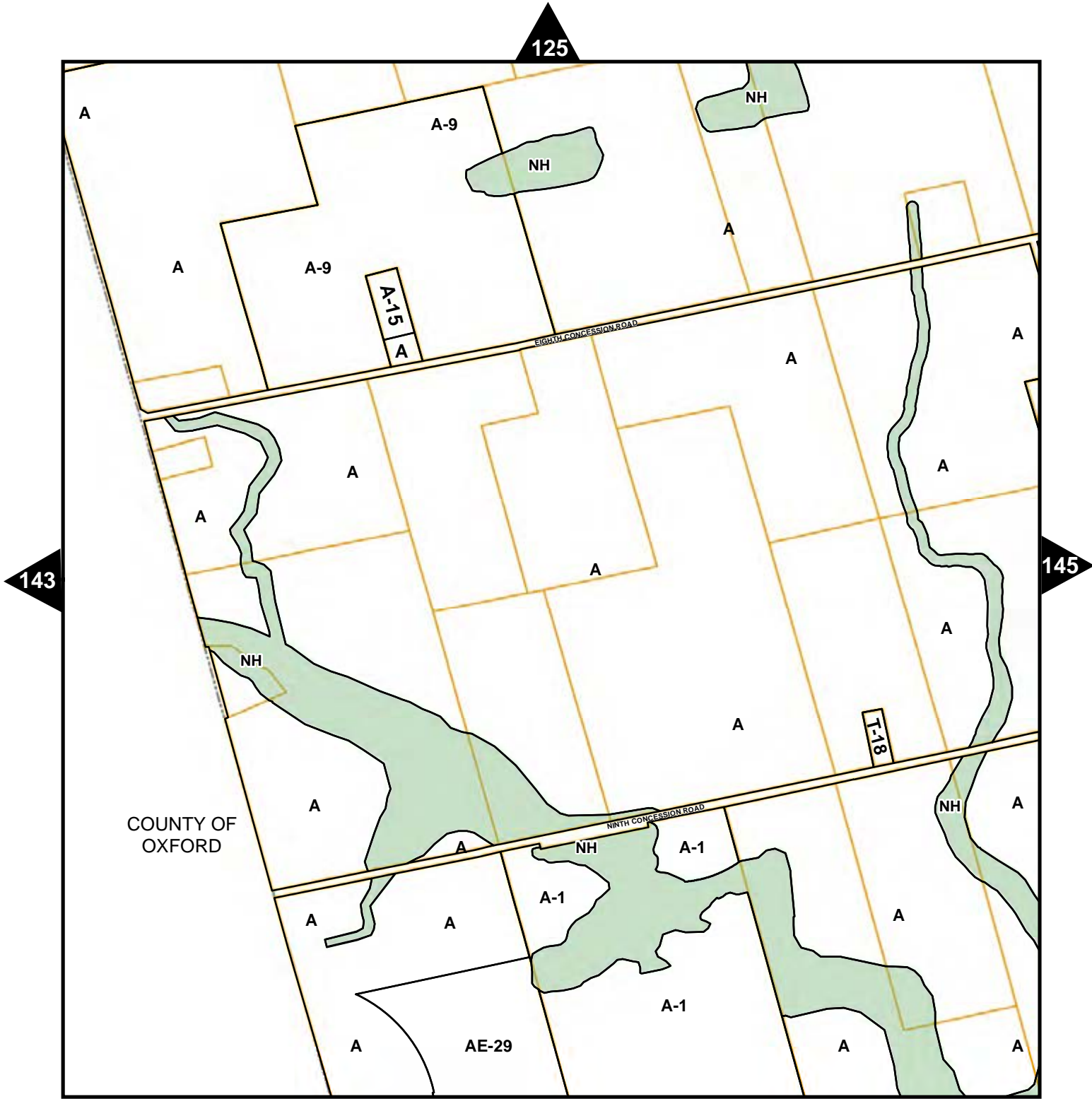

ZONING BY-LAW
SCHEDULE 'A'
Map No. 143





-  Zoning
-  Natural Heritage
-  Parcel Fabric



ZONING BY-LAW SCHEDULE 'A'

Map No. 144



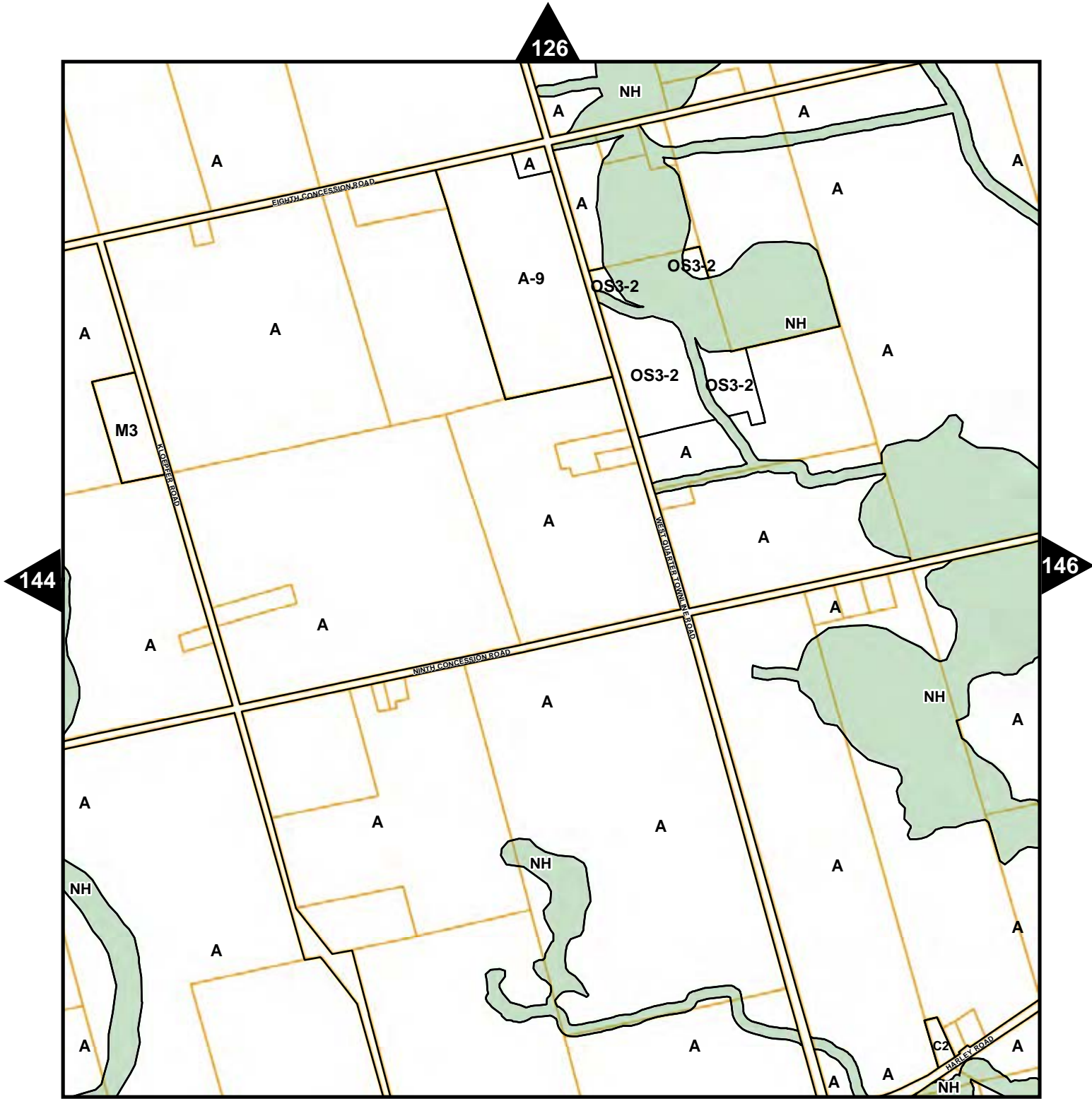

- Zoning
- Natural Heritage
- Parcel Fabric

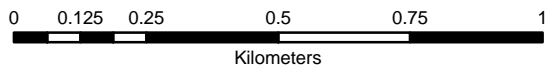

ZONING BY-LAW SCHEDULE 'A' Map No. 145

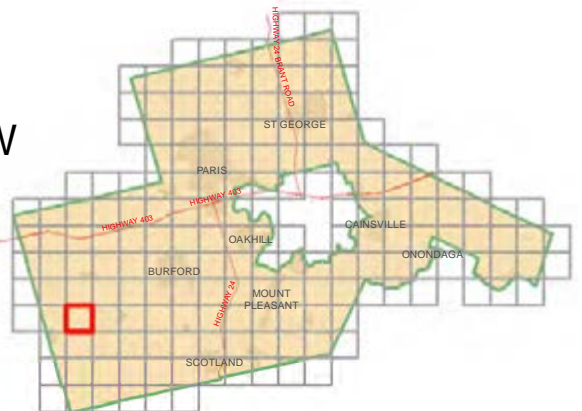

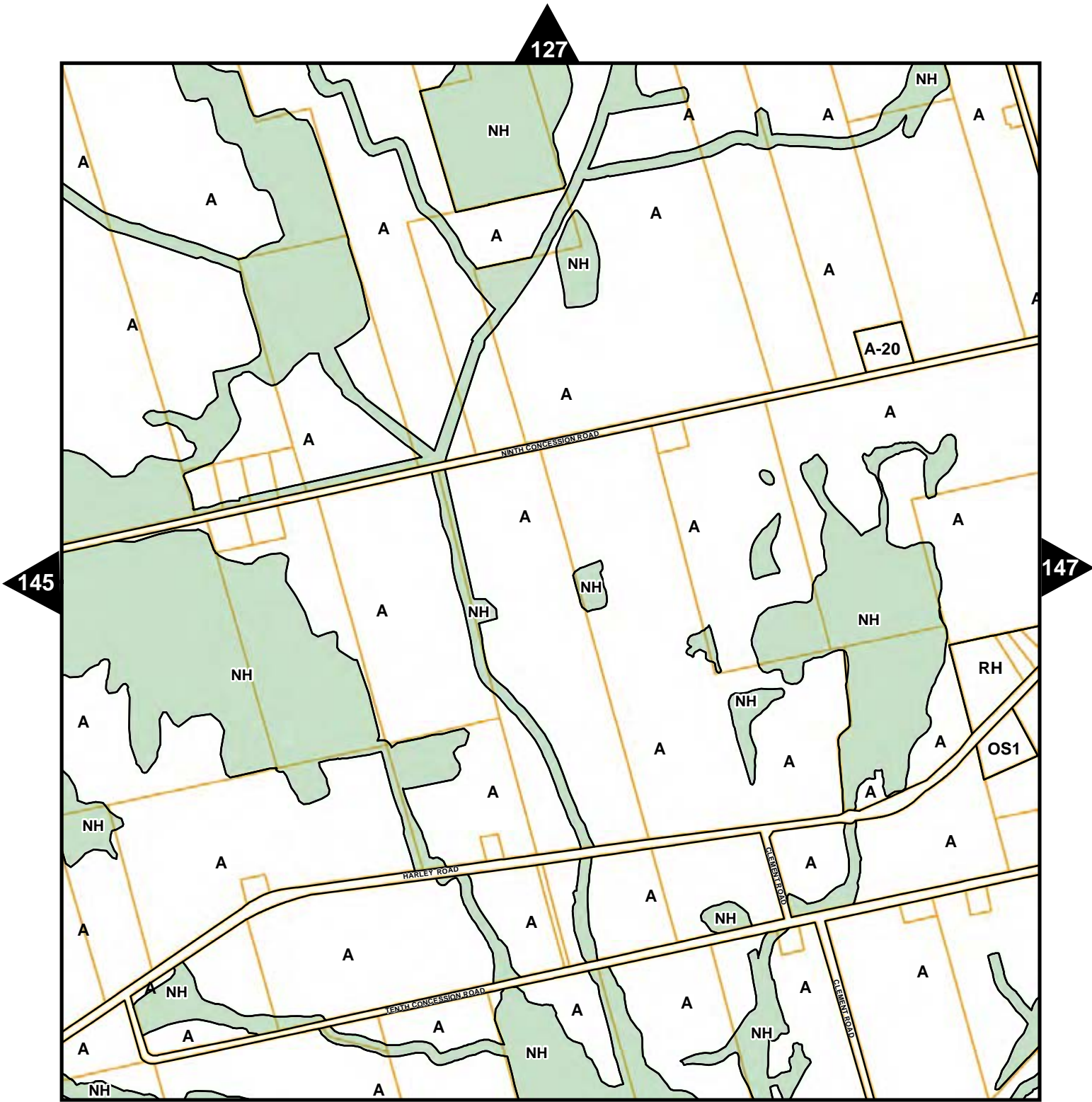

- Zoning
- Natural Heritage
- Parcel Fabric



ZONING BY-LAW SCHEDULE 'A' Map No. 146

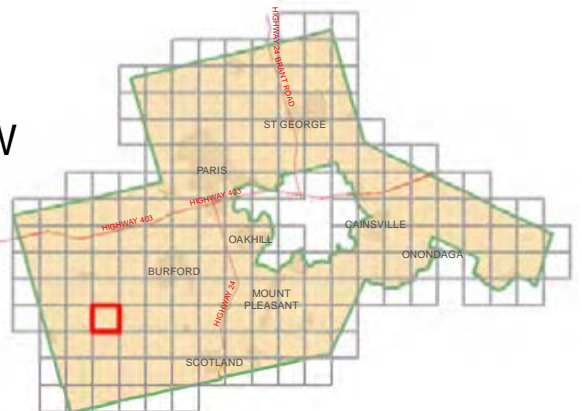

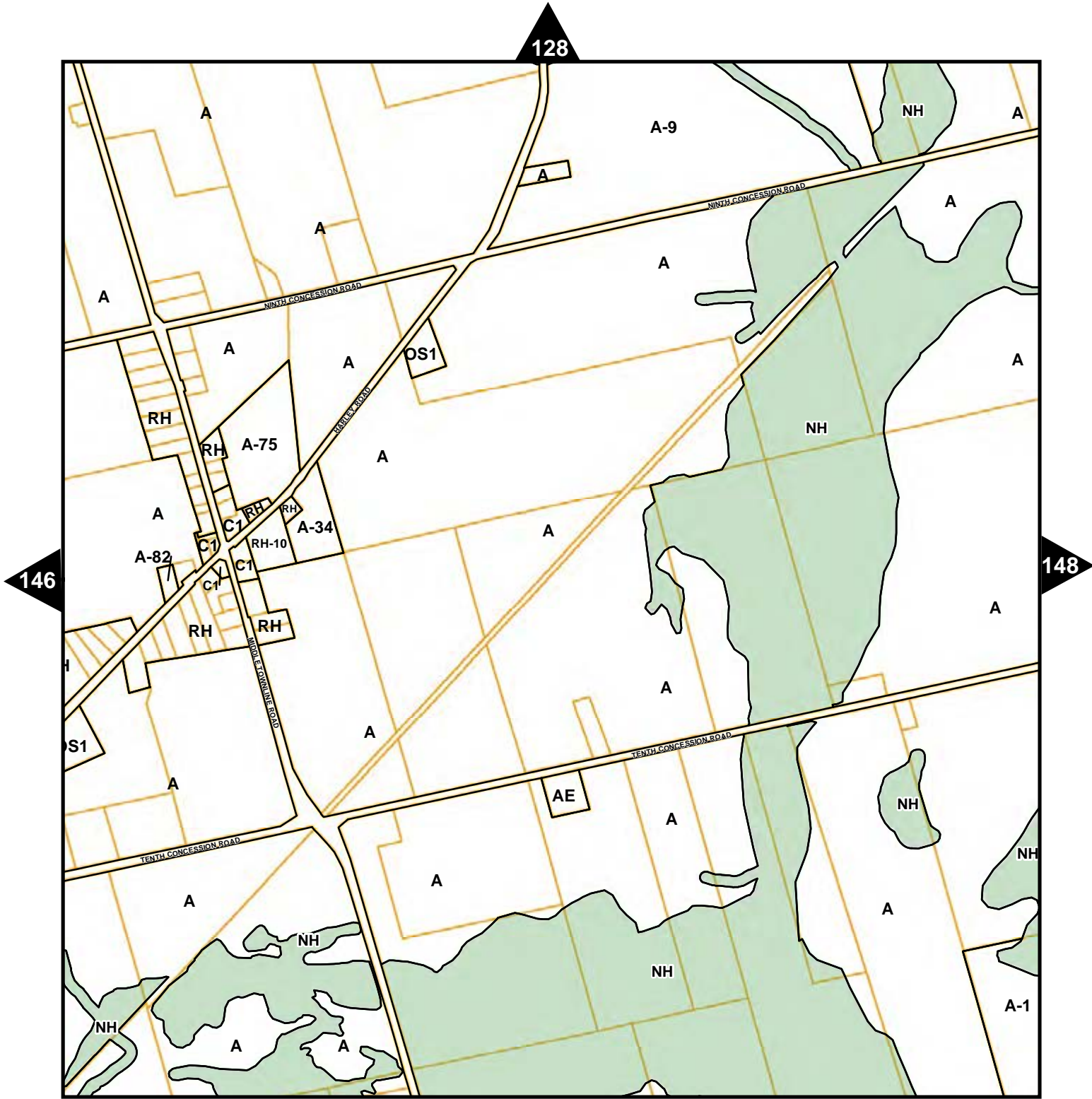

- Zoning
- Natural Heritage
- Parcel Fabric

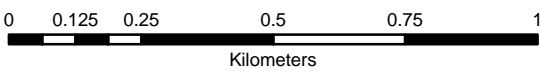

ZONING BY-LAW
SCHEDULE 'A'
Map No. 147



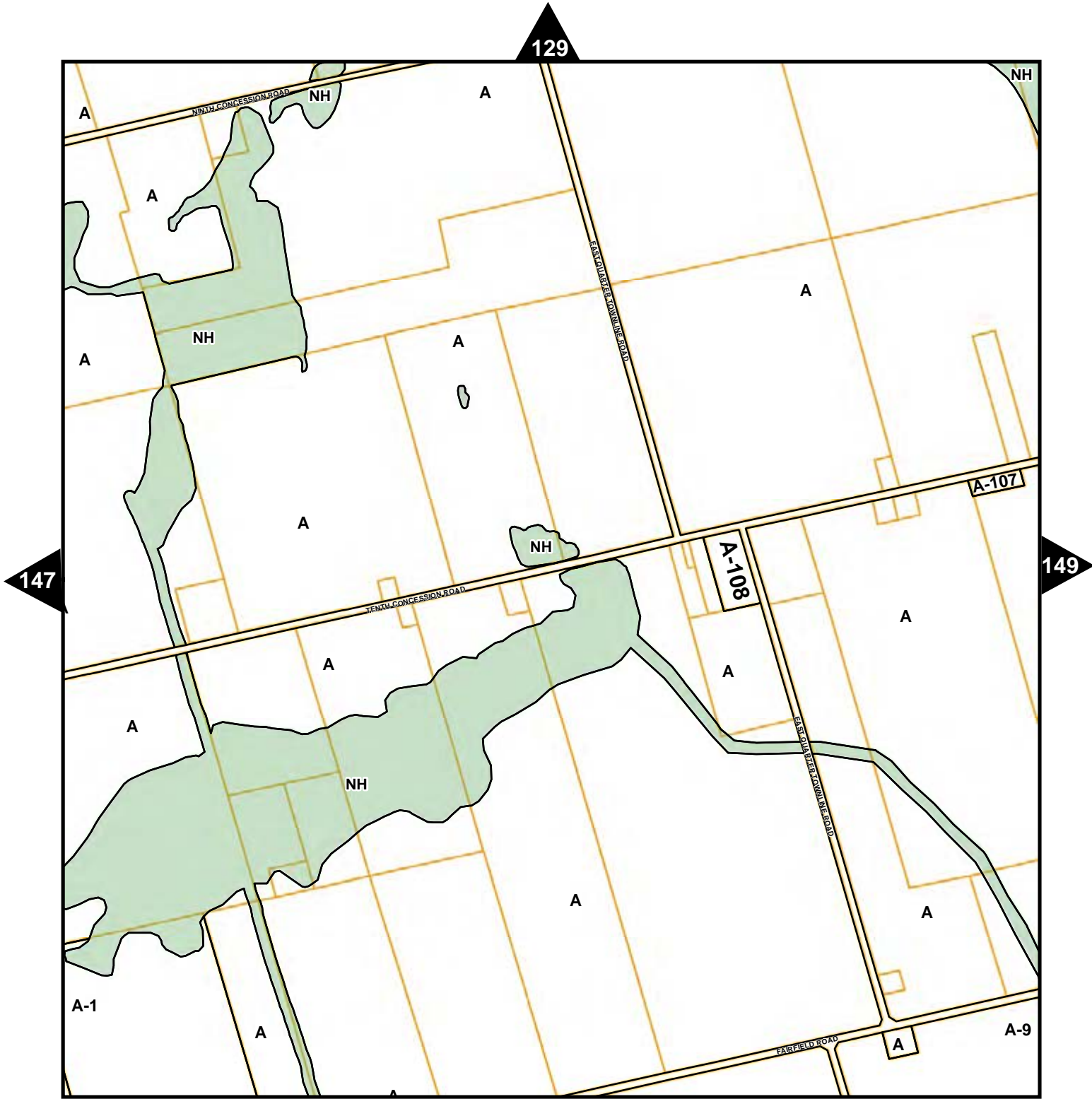

- Zoning
- Natural Heritage
- Parcel Fabric



ZONING BY-LAW
SCHEDULE 'A'
Map No. 148



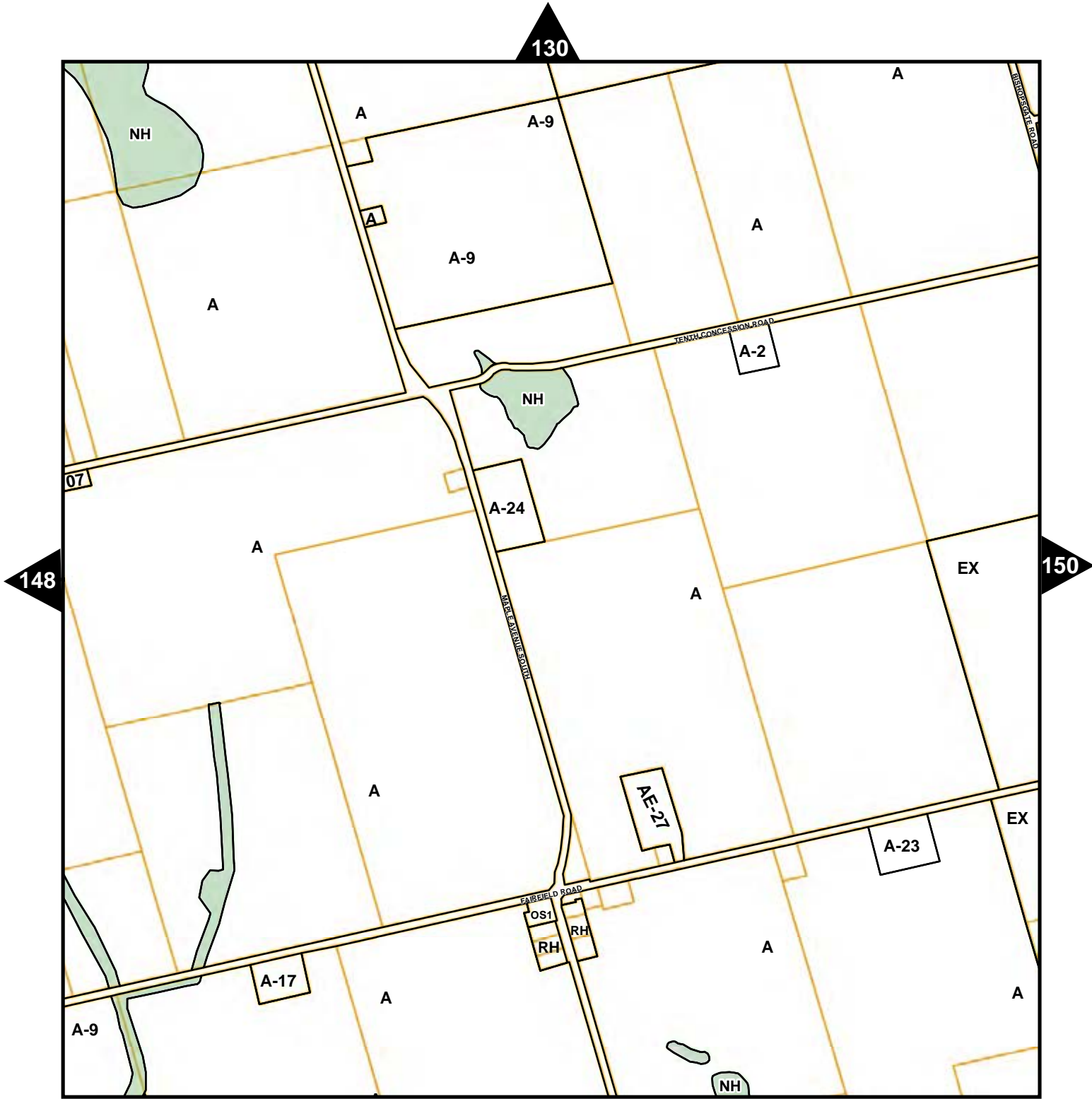

- Zoning
- Natural Heritage
- Parcel Fabric



ZONING BY-LAW SCHEDULE 'A' Map No. 149



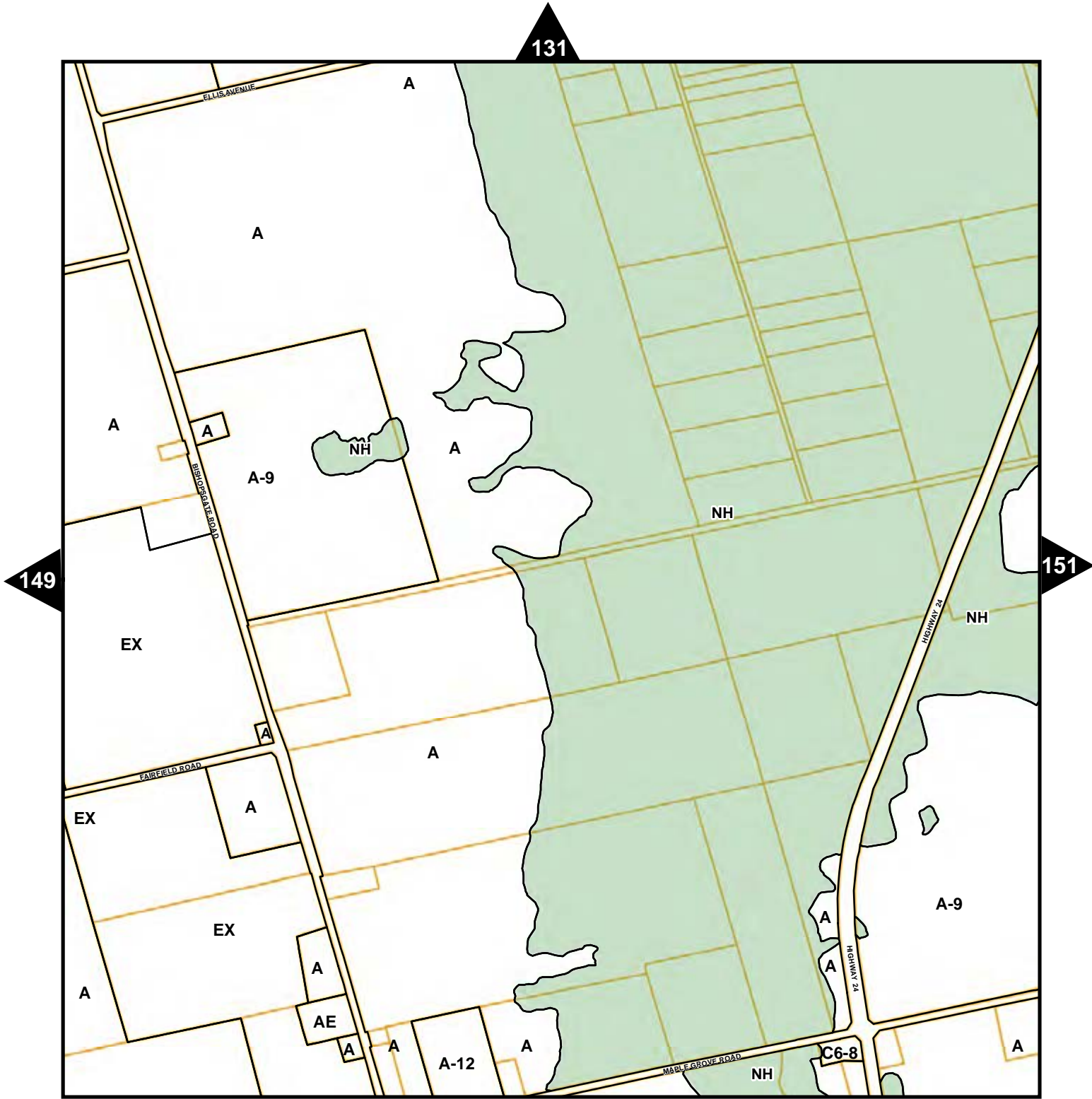

- Zoning
- Natural Heritage
- Parcel Fabric

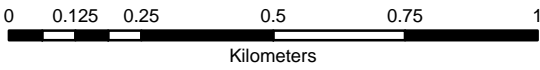

ZONING BY-LAW
SCHEDULE 'A'
Map No. 150



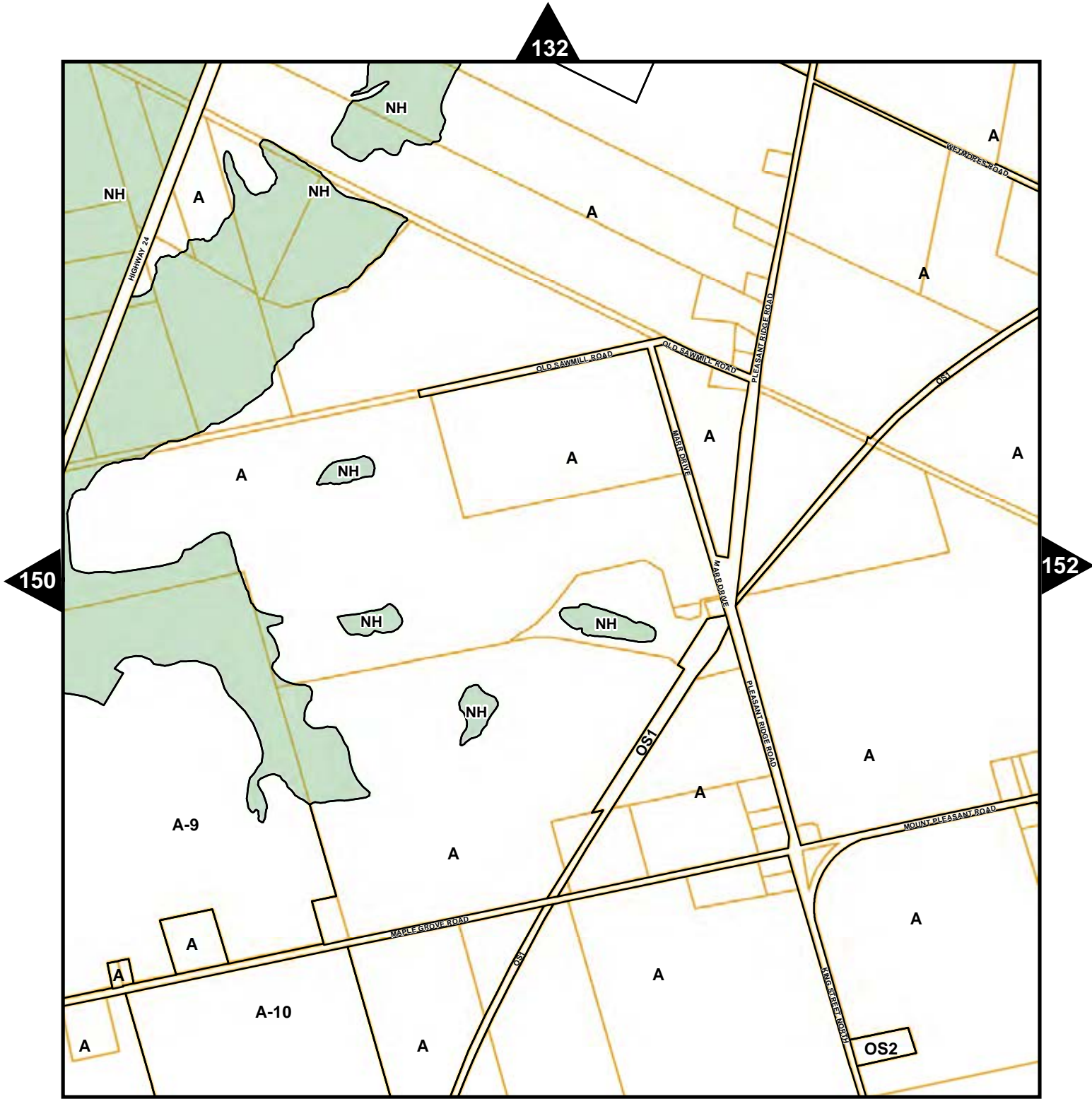

- Zoning
- Natural Heritage
- Parcel Fabric



ZONING BY-LAW SCHEDULE 'A' Map No. 151



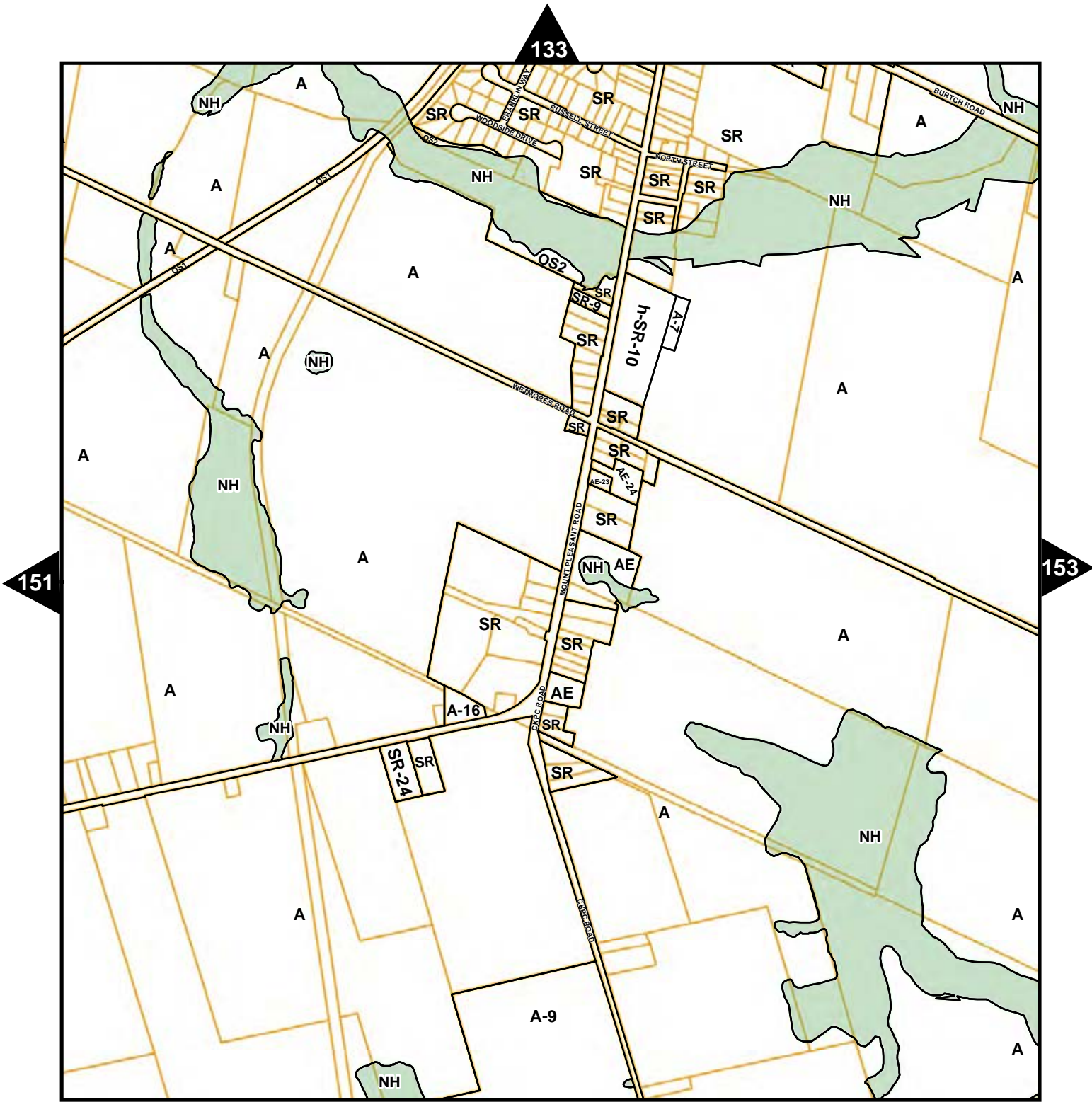

- Zoning
- Natural Heritage
- Parcel Fabric



ZONING BY-LAW
SCHEDULE 'A'
Map No. 152



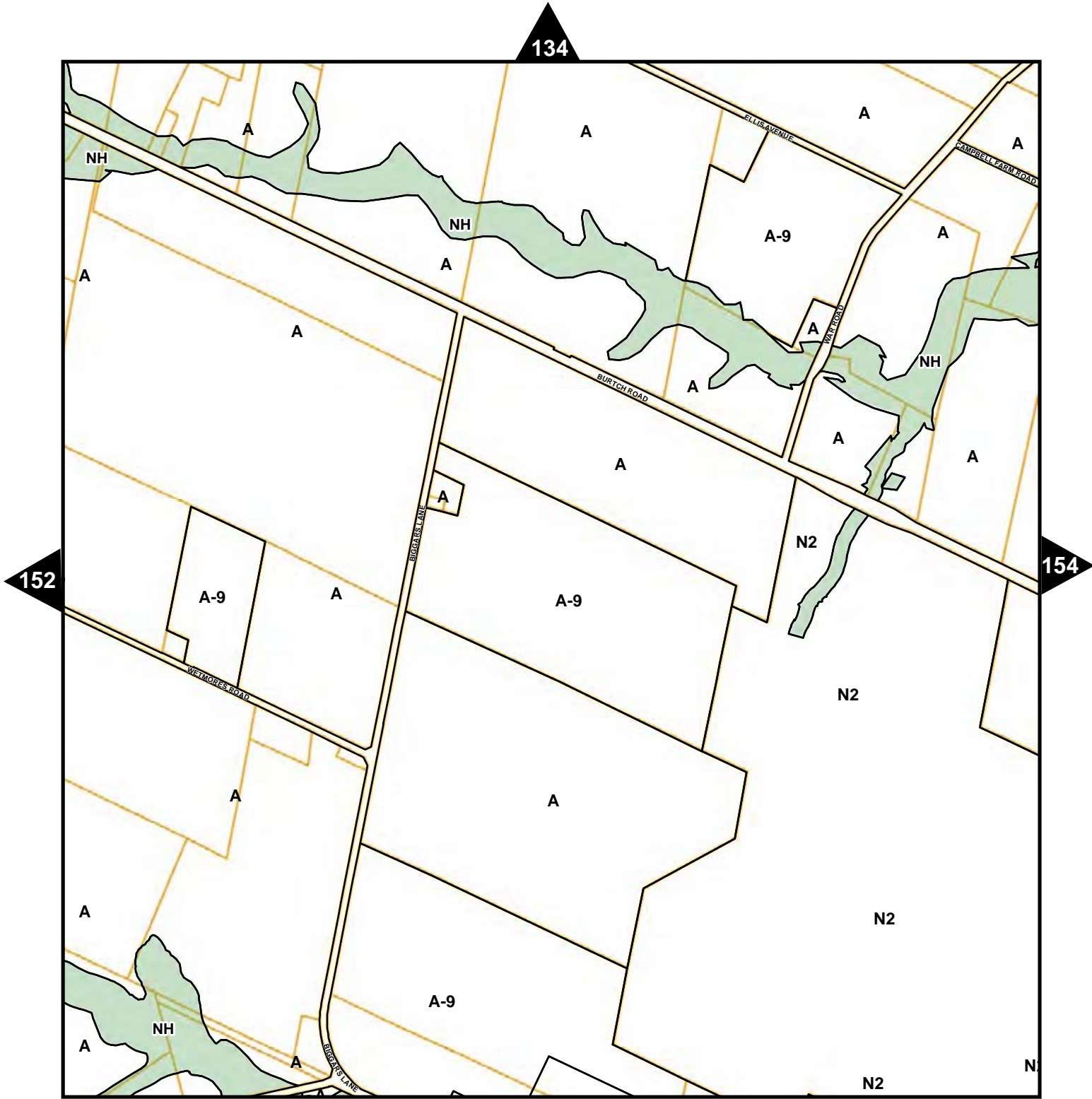

- Zoning
- Natural Heritage
- Parcel Fabric



ZONING BY-LAW SCHEDULE 'A' Map No. 153



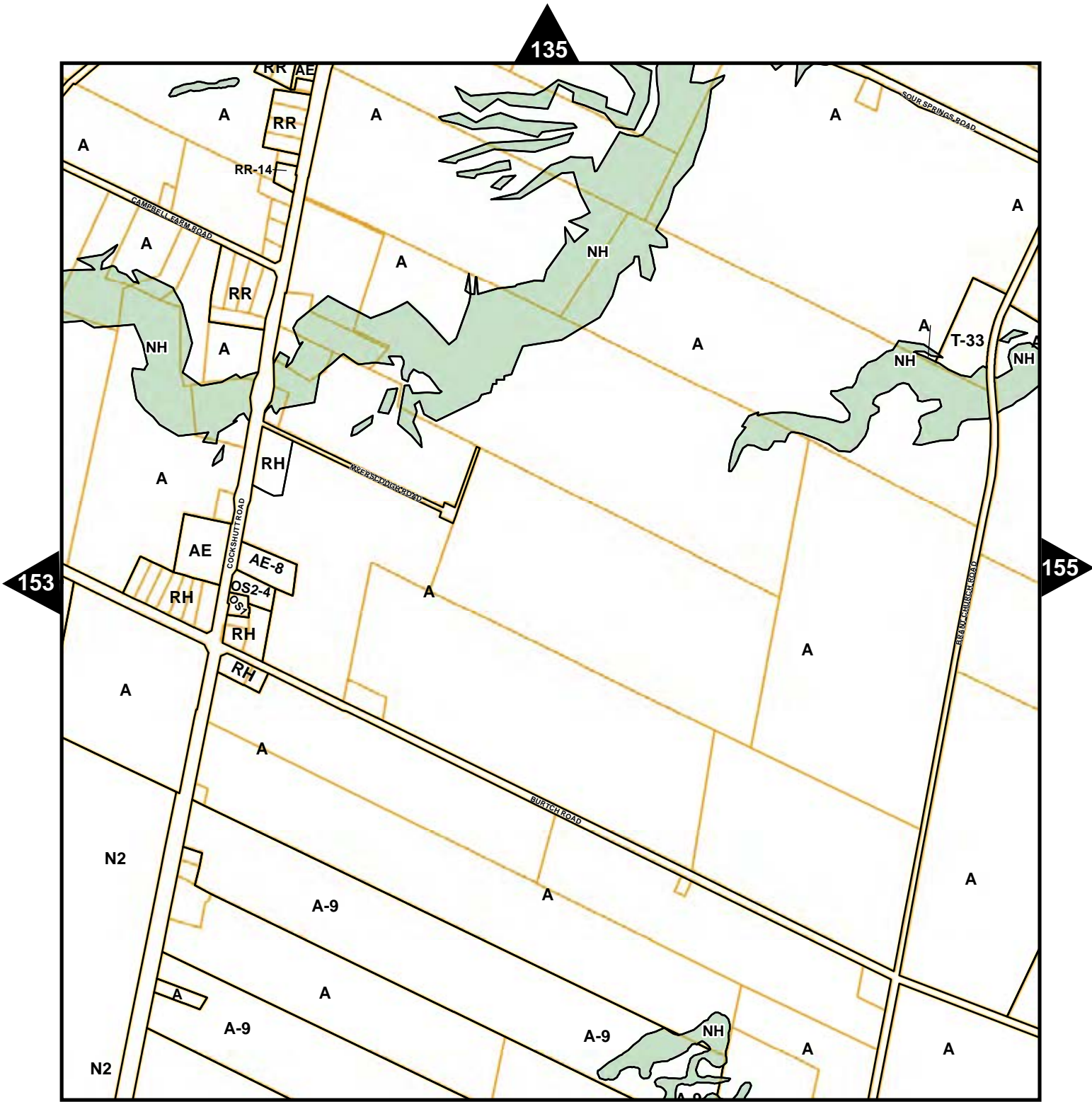

- Zoning
- Natural Heritage
- Parcel Fabric



ZONING BY-LAW SCHEDULE 'A' Map No. 154



136

154

167

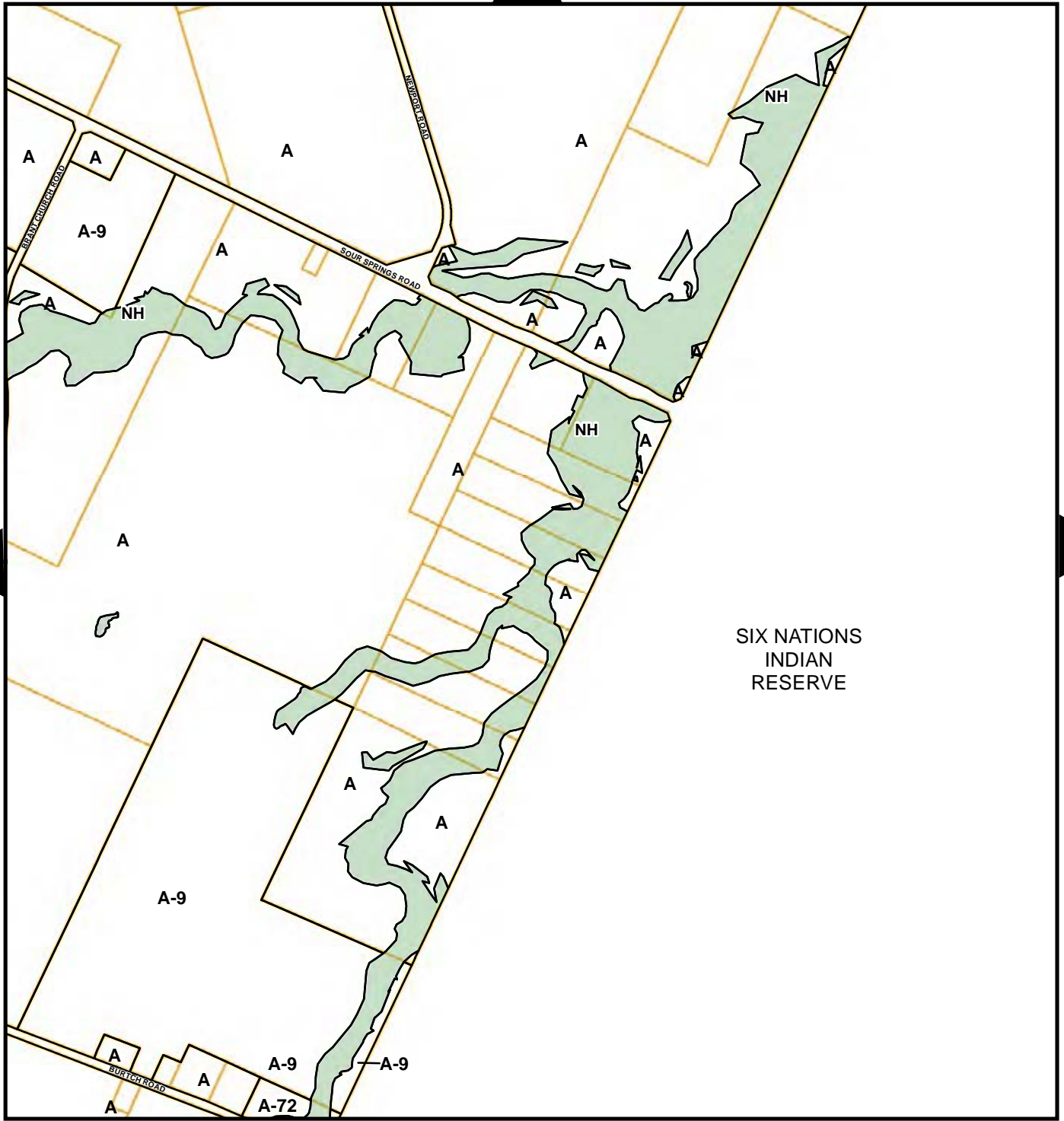

SIX NATIONS INDIAN RESERVE



- Zoning
- Natural Heritage
- Parcel Fabric

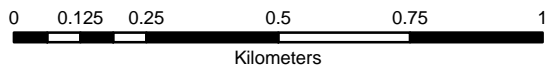

ZONING BY-LAW
SCHEDULE 'A'
Map No. 155



144

157

168

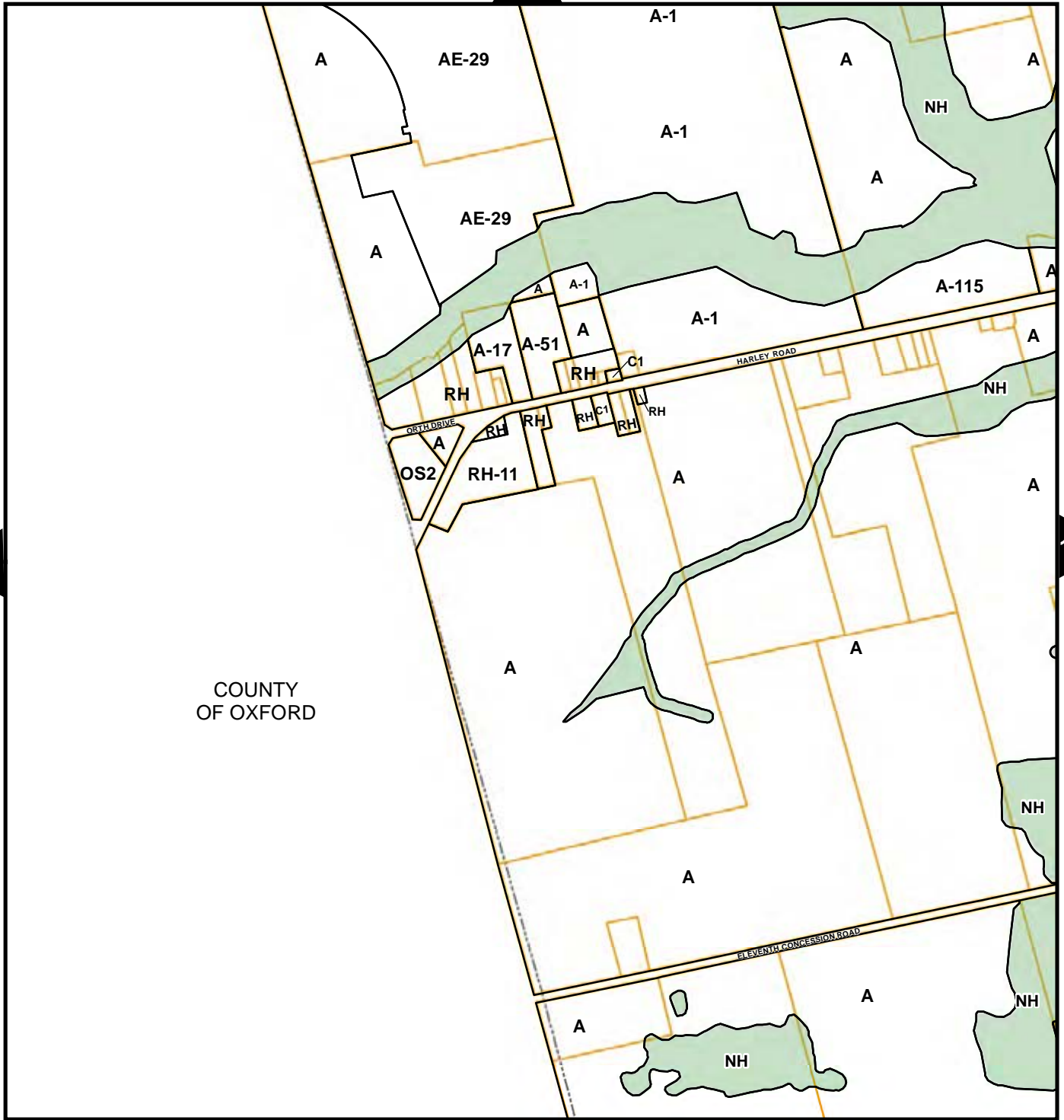

COUNTY OF OXFORD



- Zoning
- Natural Heritage
- Parcel Fabric

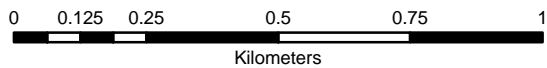

ZONING BY-LAW SCHEDULE 'A' Map No. 156



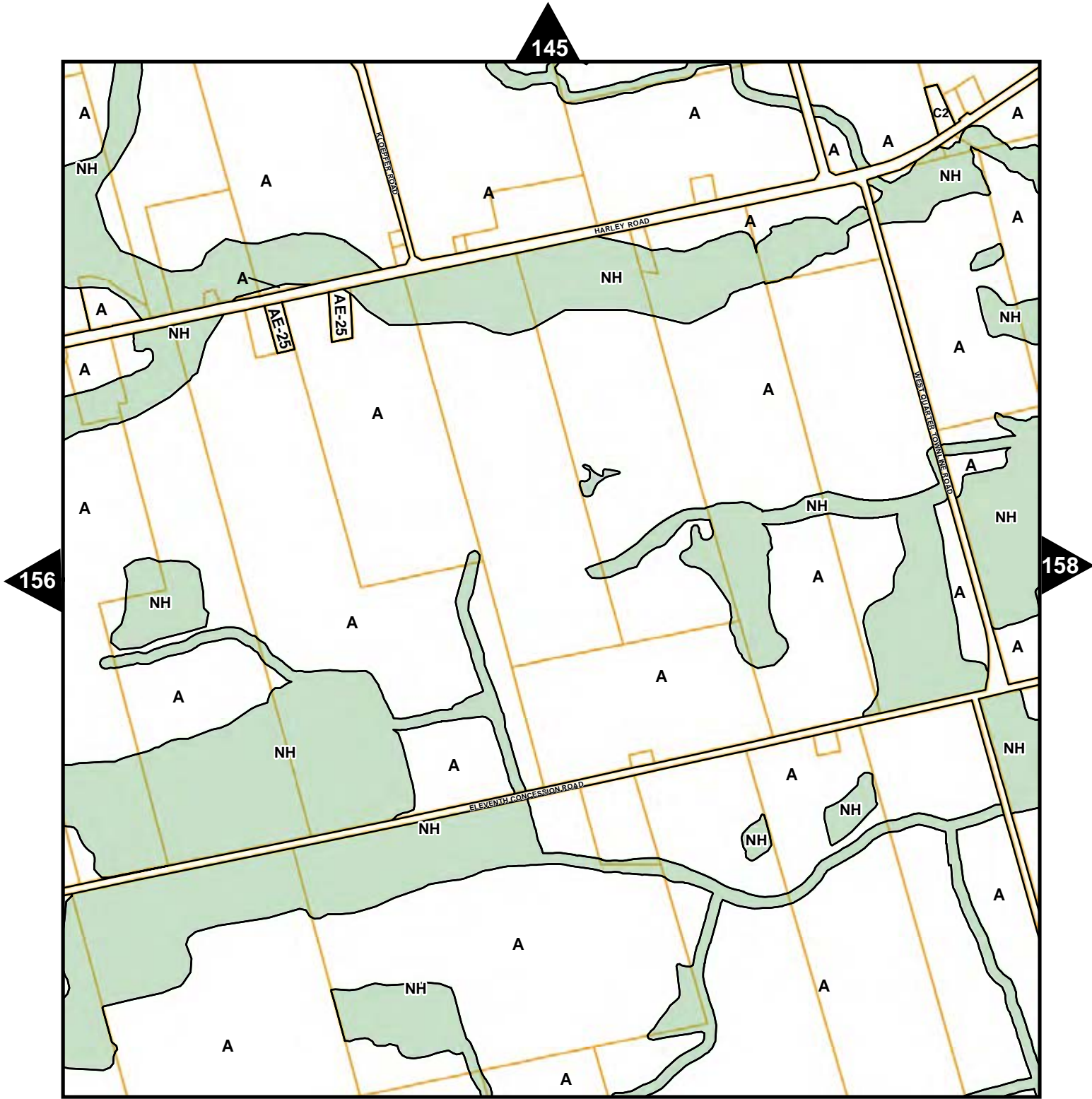

- Zoning
- Natural Heritage
- Parcel Fabric



ZONING BY-LAW SCHEDULE 'A' Map No. 157



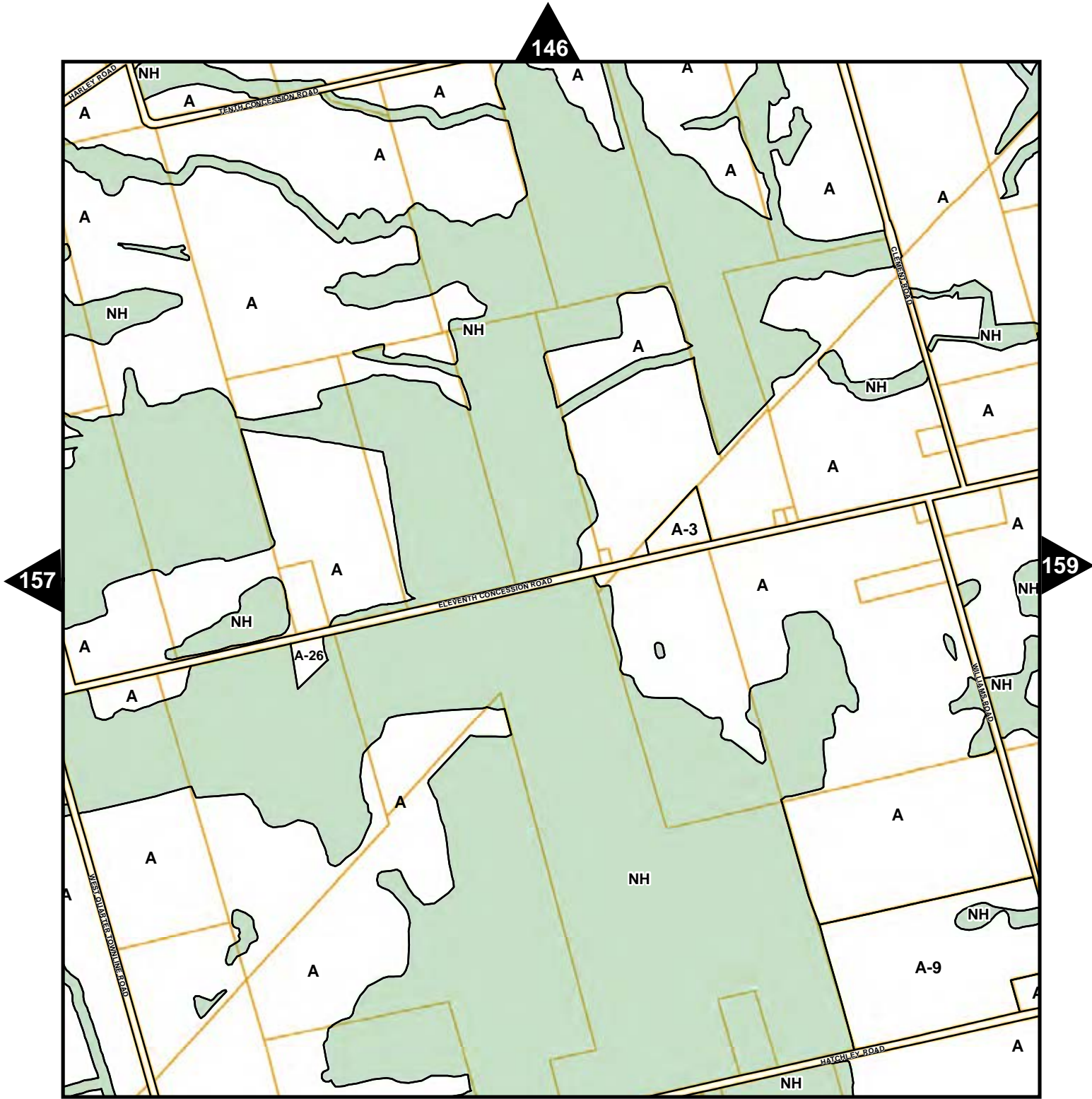

- Zoning
- Natural Heritage
- Parcel Fabric

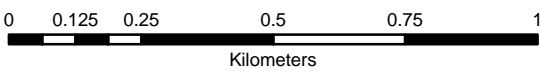

ZONING BY-LAW
SCHEDULE 'A'
Map No. 158



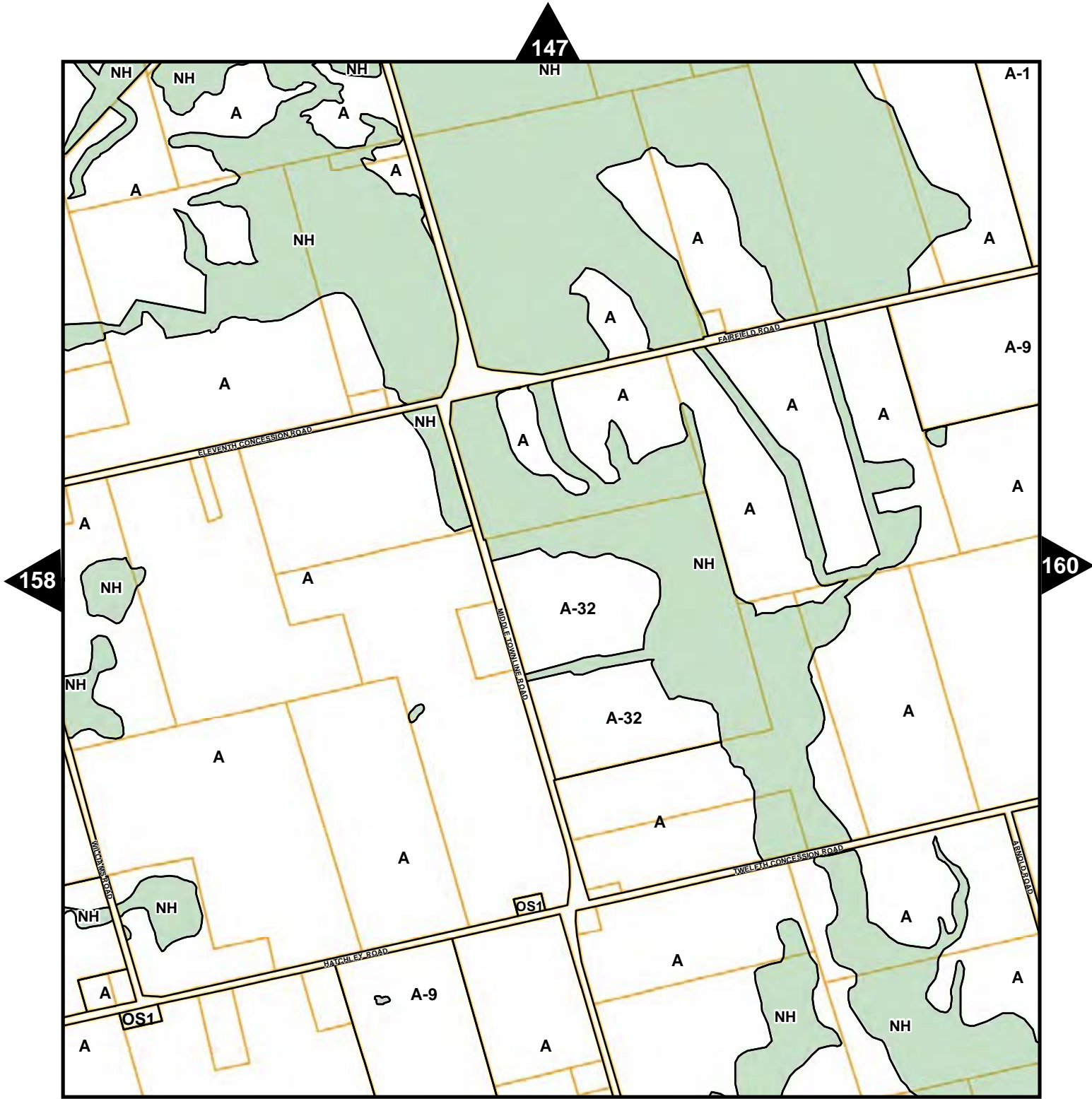

- Zoning
- Natural Heritage
- Parcel Fabric



ZONING BY-LAW SCHEDULE 'A' Map No. 159



148

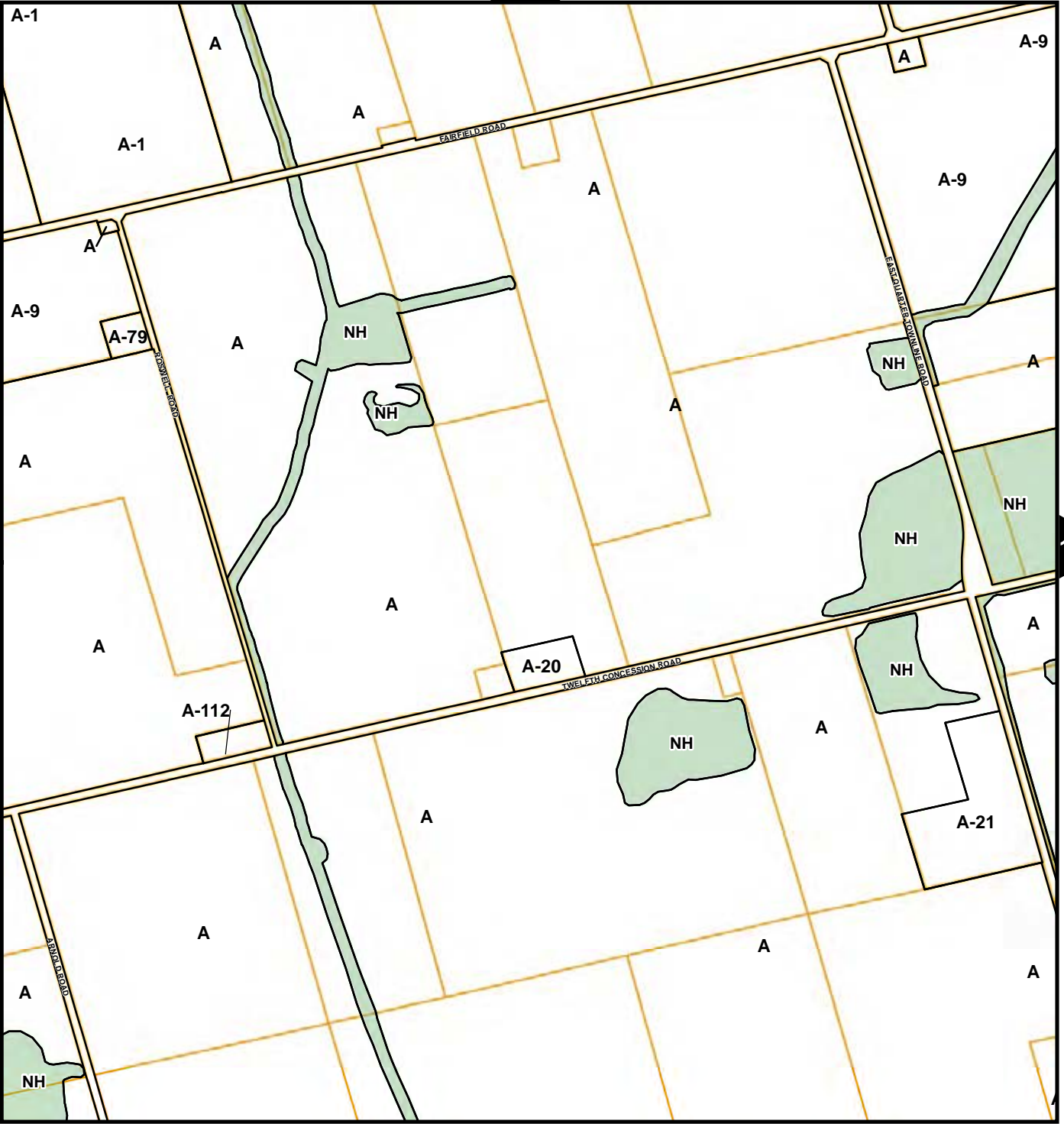

172



ZONING BY-LAW
SCHEDULE 'A'
Map No. 160

- Zoning
- Natural Heritage
- Parcel Fabric

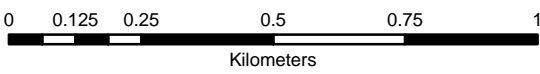



- Zoning
- Natural Heritage
- Parcel Fabric



ZONING BY-LAW SCHEDULE 'A' Map No. 161





- Zoning
- Natural Heritage
- Parcel Fabric

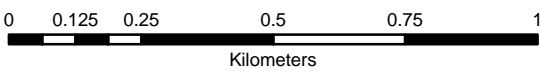

ZONING BY-LAW
SCHEDULE 'A'
Map No. 162



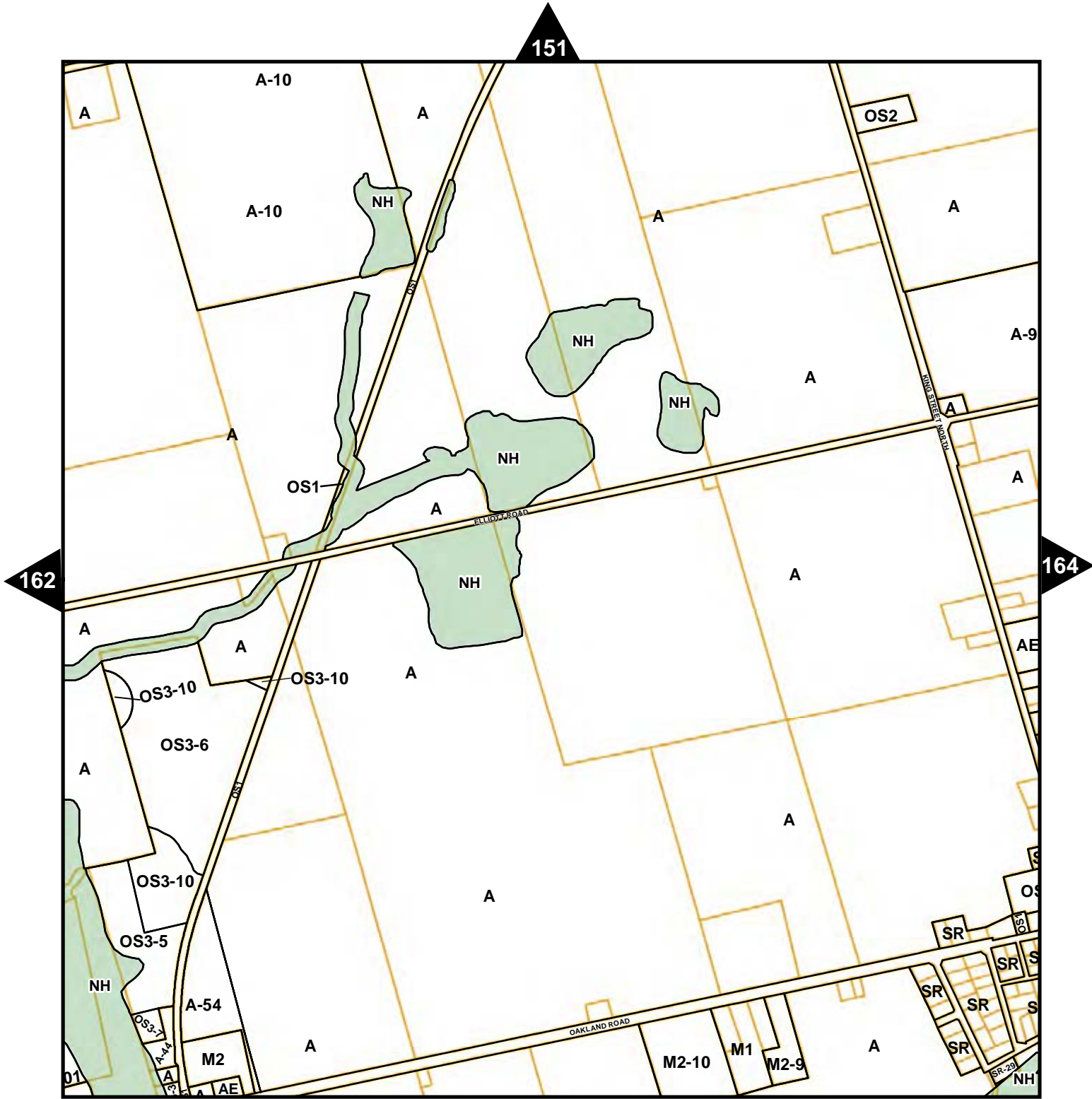

- Zoning
- Natural Heritage
- Parcel Fabric



ZONING BY-LAW
SCHEDULE 'A'
Map No. 163



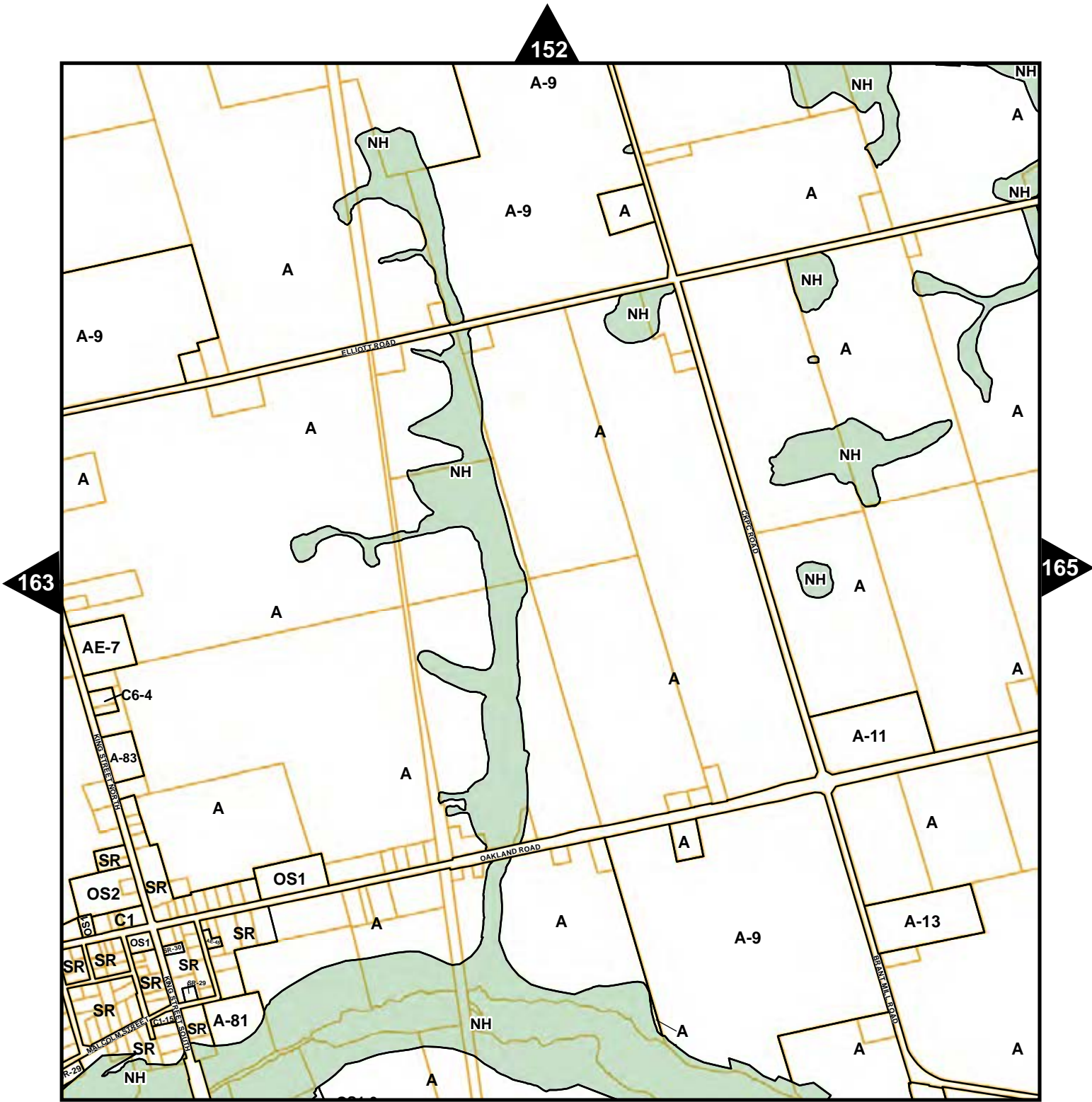

- Zoning
- Natural Heritage
- Parcel Fabric

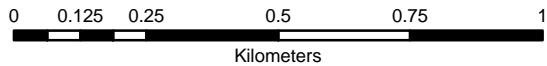

ZONING BY-LAW SCHEDULE 'A'

Map No. 164



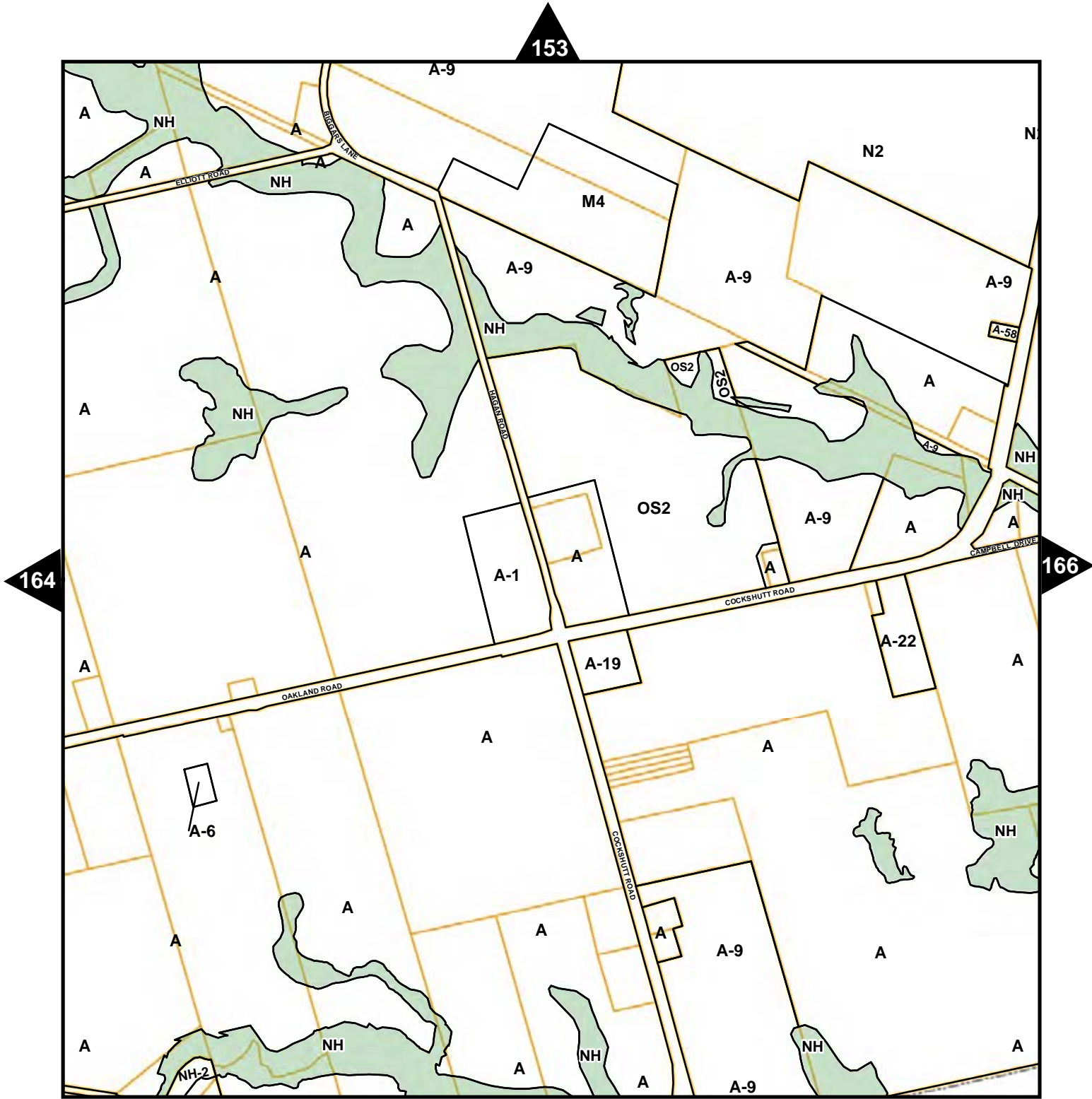

- Zoning
- Natural Heritage
- Parcel Fabric

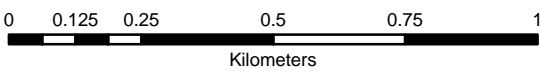

ZONING BY-LAW
SCHEDULE 'A'
Map No. 165



154

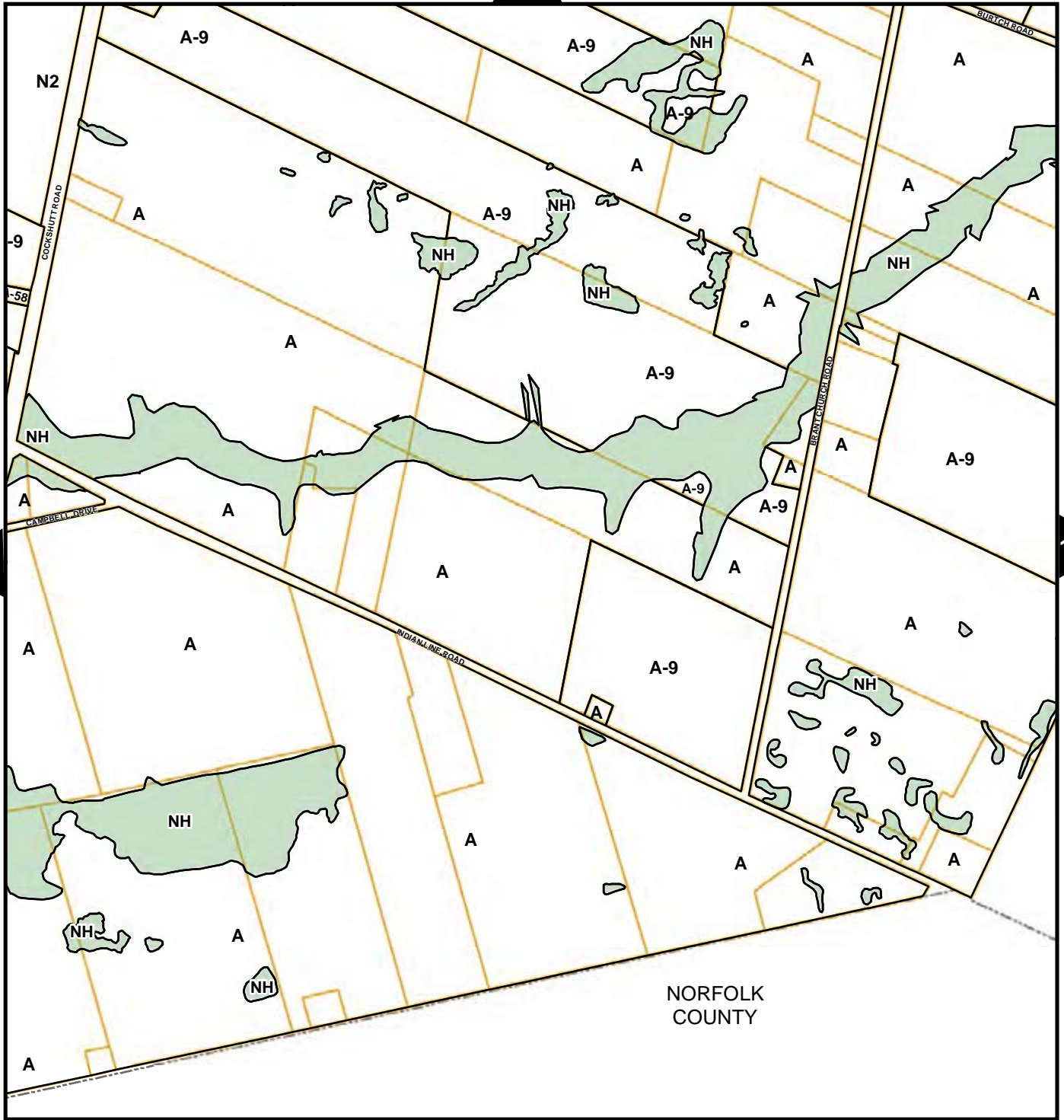

167

165

NORFOLK COUNTY

178



- Zoning
- Natural Heritage
- Parcel Fabric

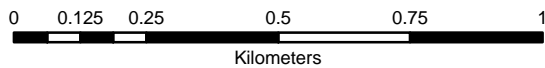

ZONING BY-LAW
SCHEDULE 'A'
Map No. 166



155

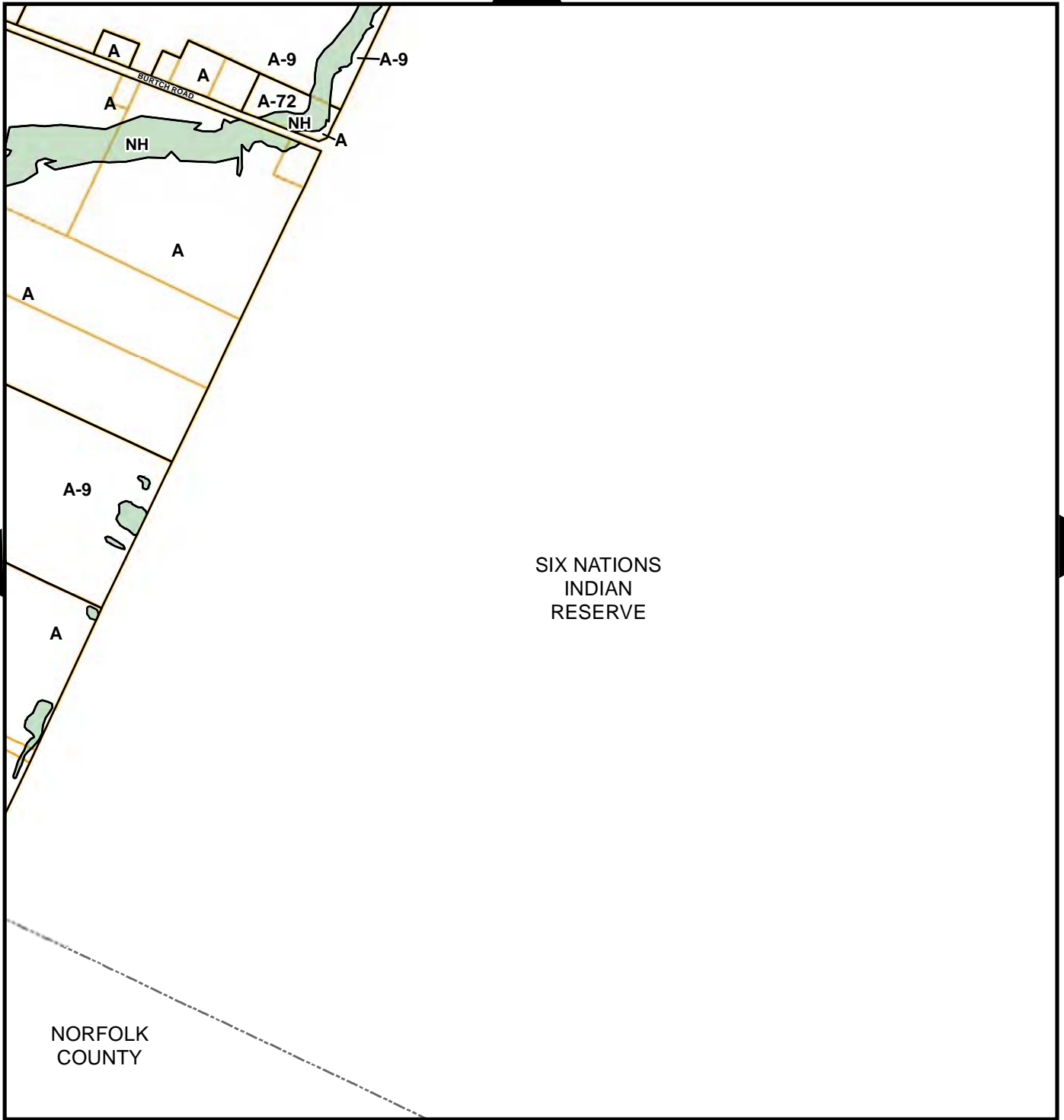



166

SIX NATIONS INDIAN RESERVE

NORFOLK COUNTY



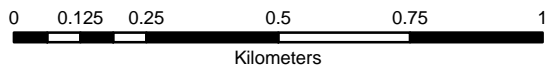

ZONING BY-LAW
SCHEDULE 'A'
Map No. 167

-  Zoning
-  Natural Heritage
-  Parcel Fabric

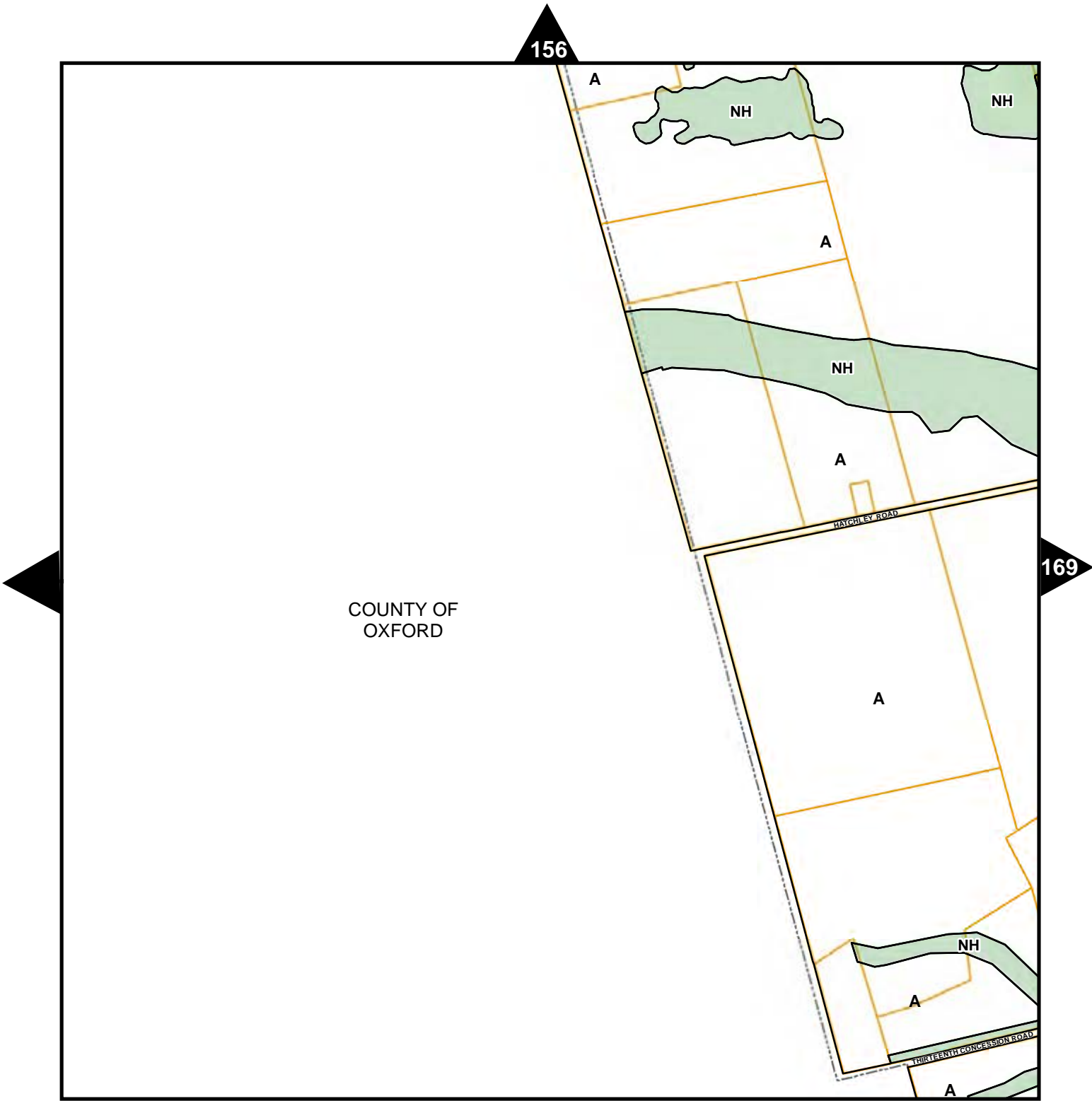



-  Zoning
-  Natural Heritage
-  Parcel Fabric

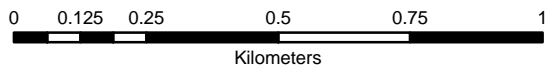

ZONING BY-LAW
SCHEDULE 'A'
Map No. 168



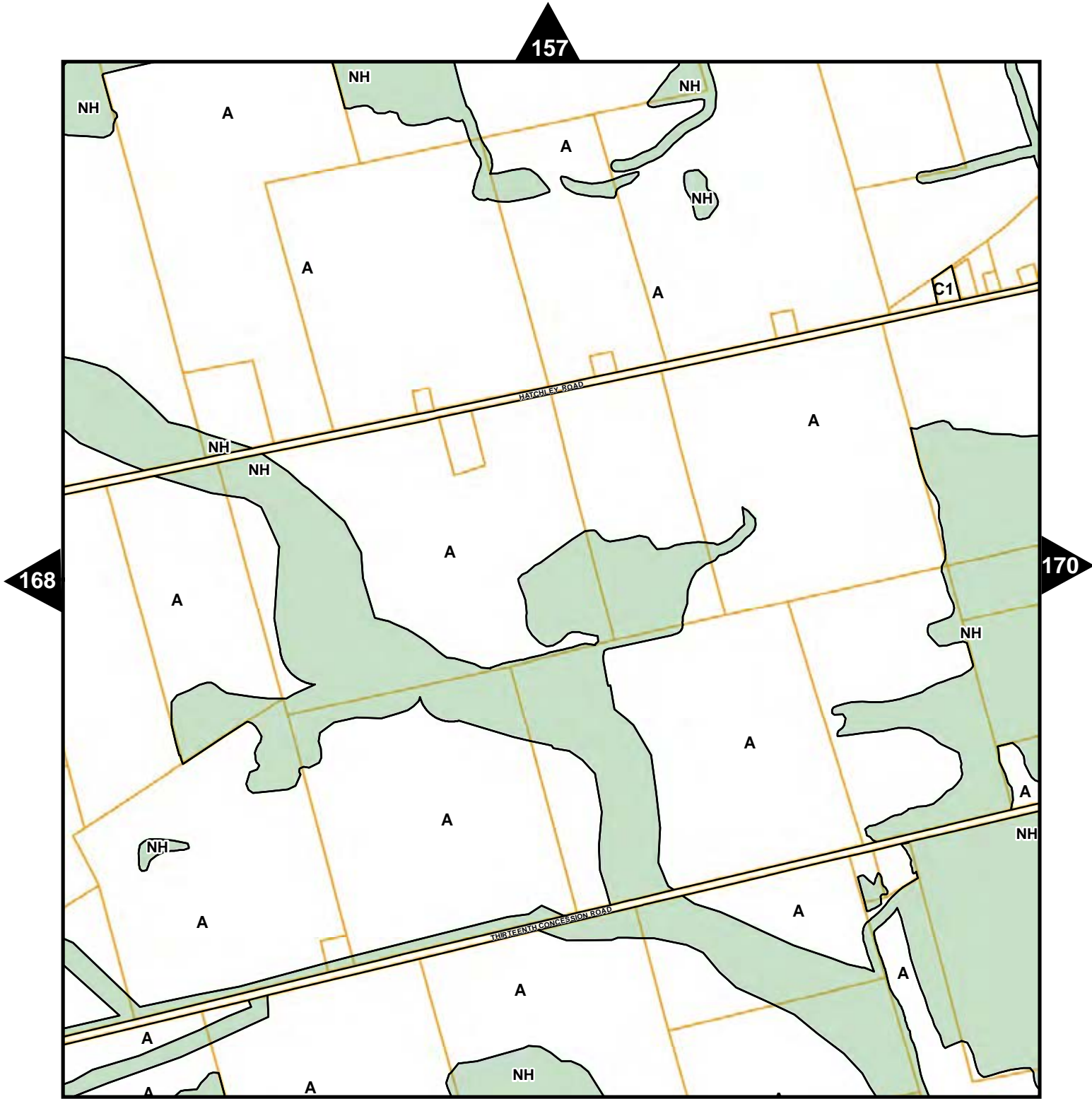

- Zoning
- Natural Heritage
- Parcel Fabric



ZONING BY-LAW
SCHEDULE 'A'
Map No. 169





- Zoning
- Natural Heritage
- Parcel Fabric



ZONING BY-LAW SCHEDULE 'A' Map No. 170









- Zoning
- Natural Heritage
- Parcel Fabric

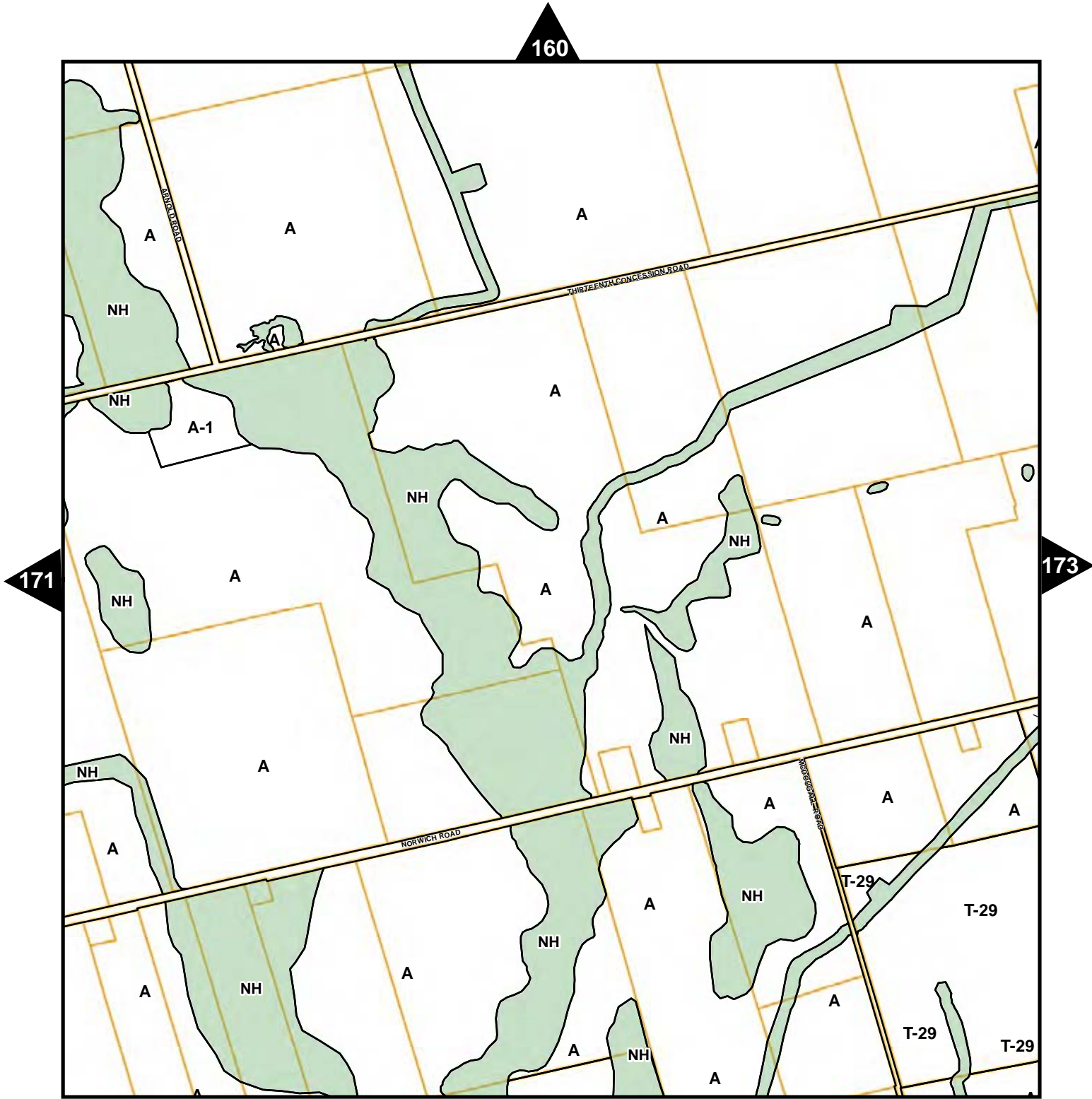

ZONING BY-LAW
SCHEDULE 'A'
Map No. 171





-  Zoning
-  Natural Heritage
-  Parcel Fabric



ZONING BY-LAW SCHEDULE 'A' Map No. 172



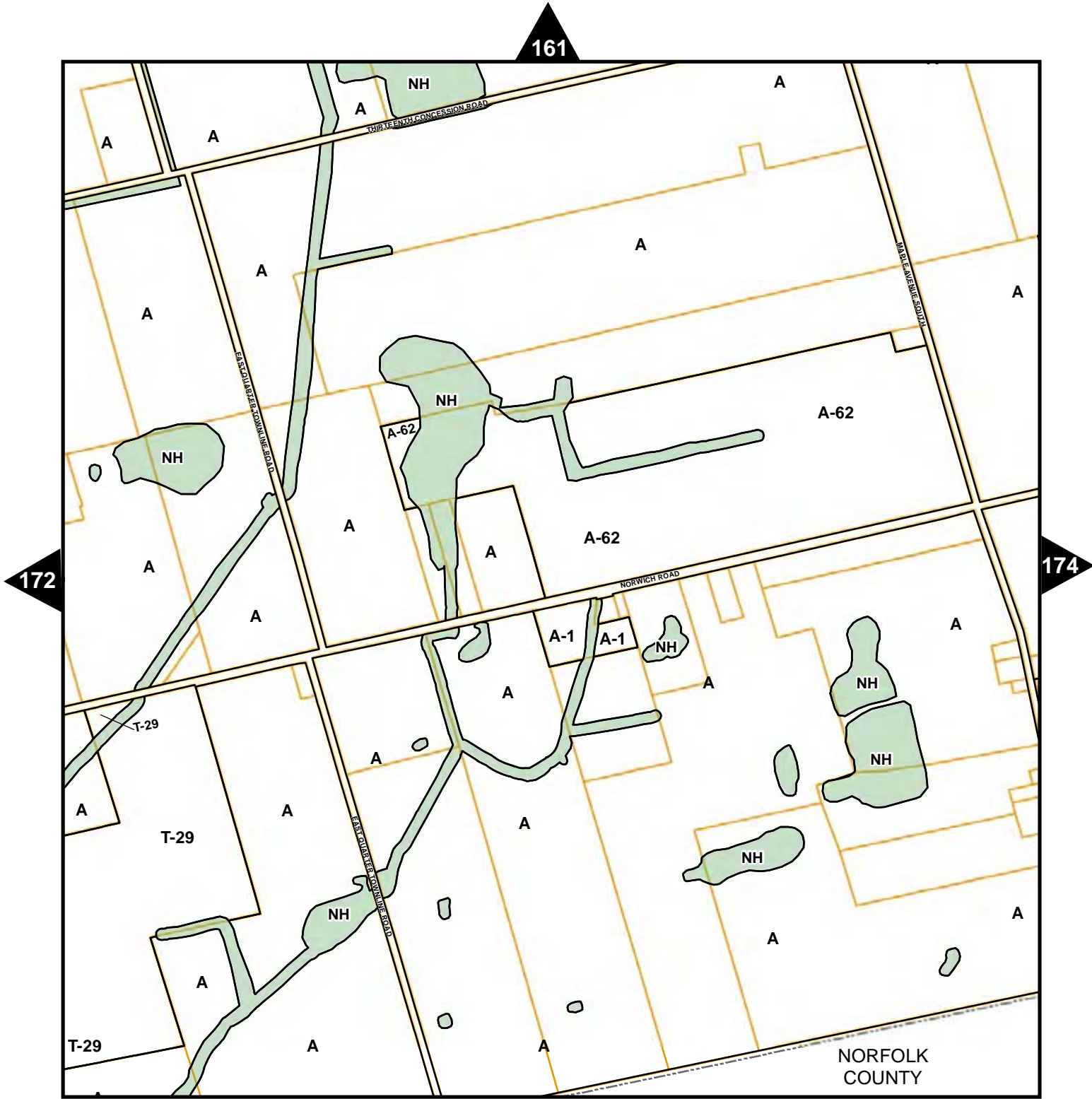

- Zoning
- Natural Heritage
- Parcel Fabric



ZONING BY-LAW SCHEDULE 'A' Map No. 173



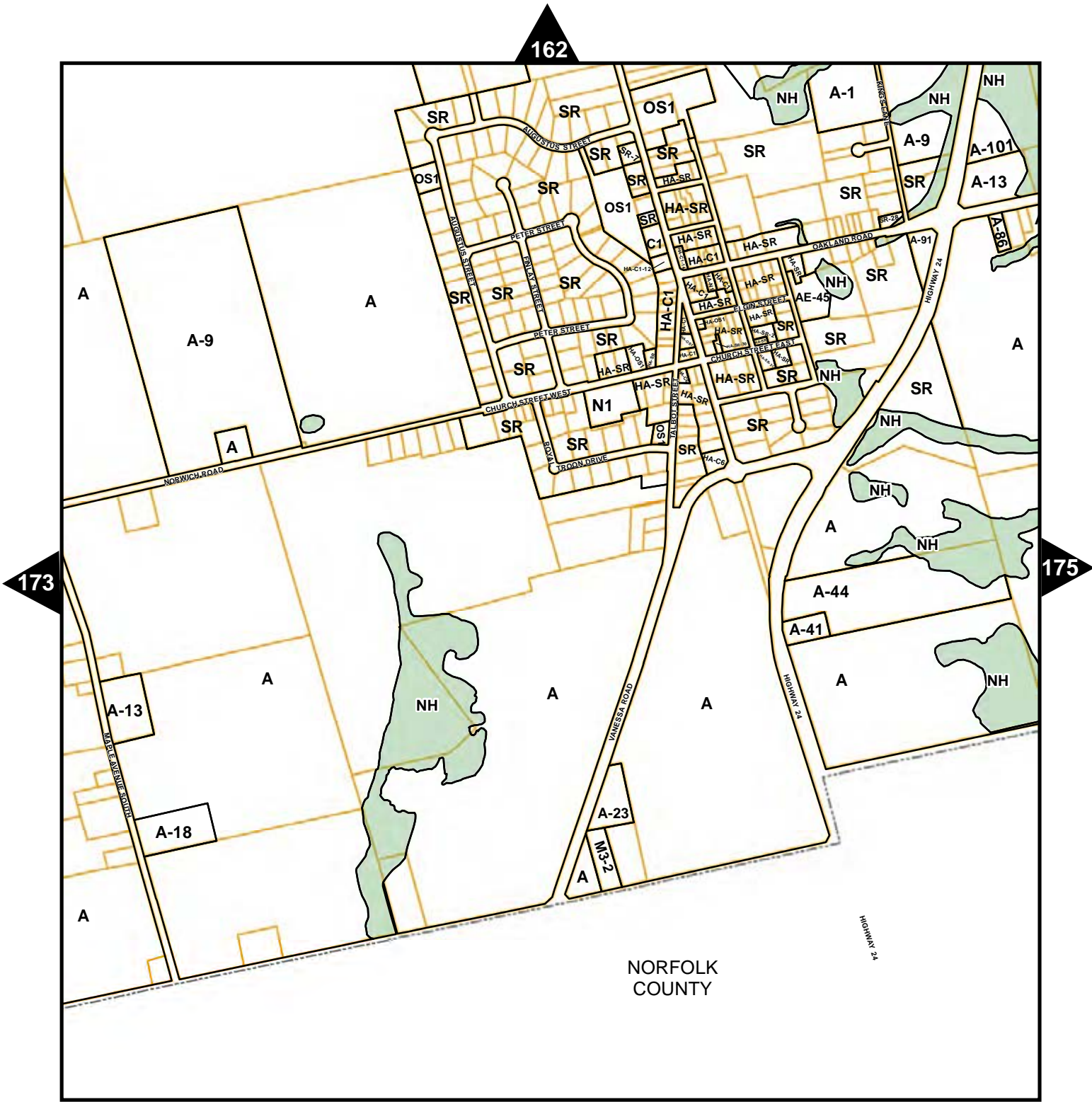

- Zoning
- Natural Heritage
- Parcel Fabric



ZONING BY-LAW
SCHEDULE 'A'
Map No. 174



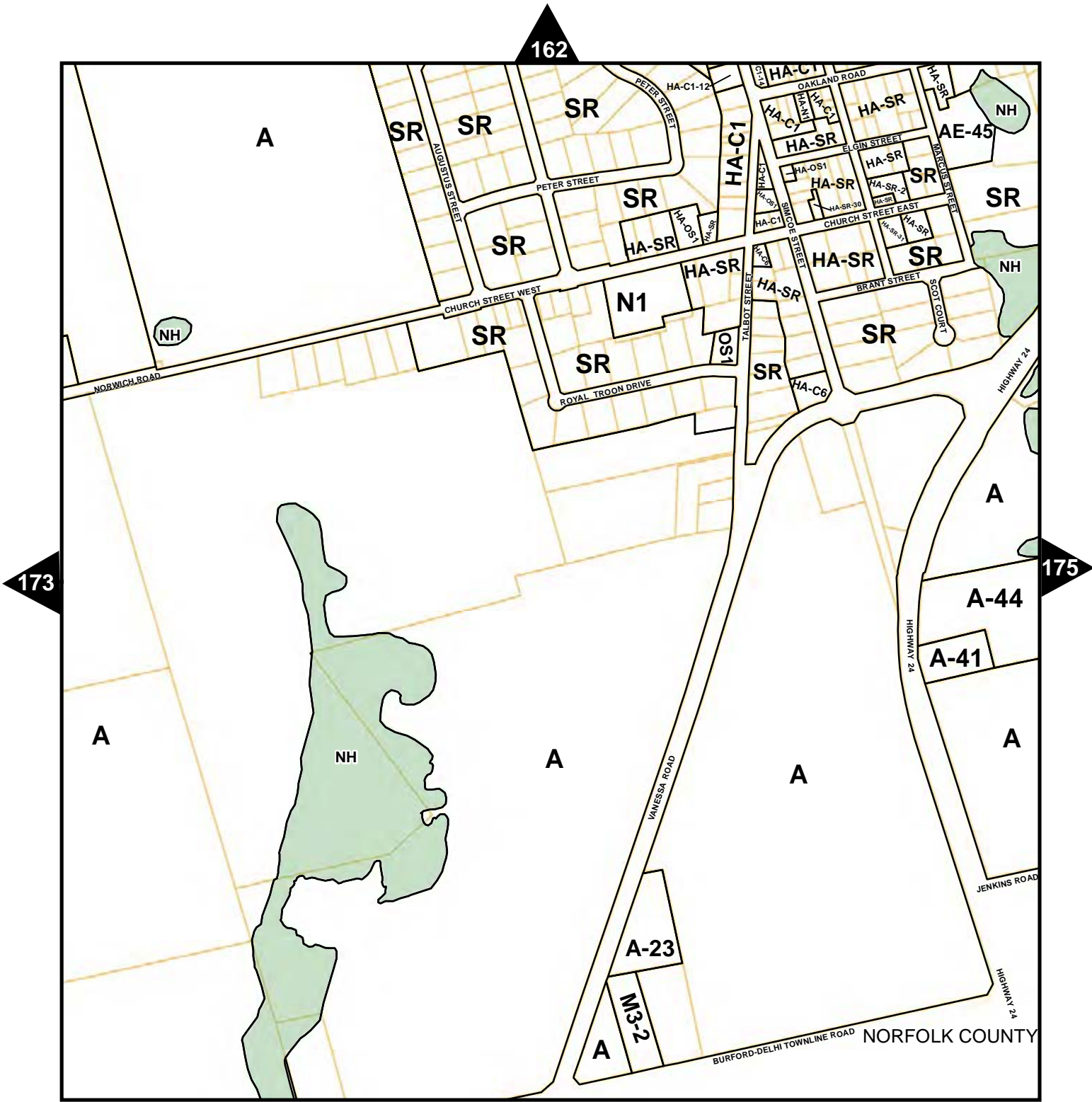



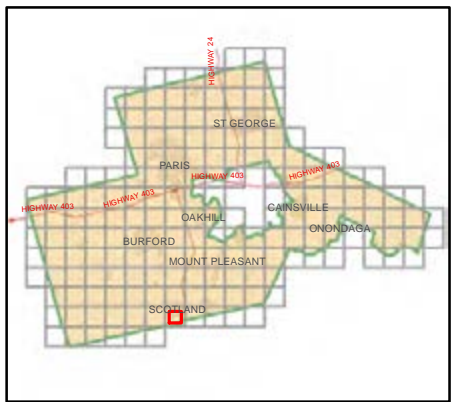
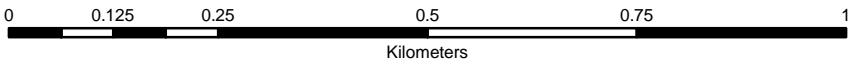

- Zoning
- Natural Hazard
- Parcel Fabric

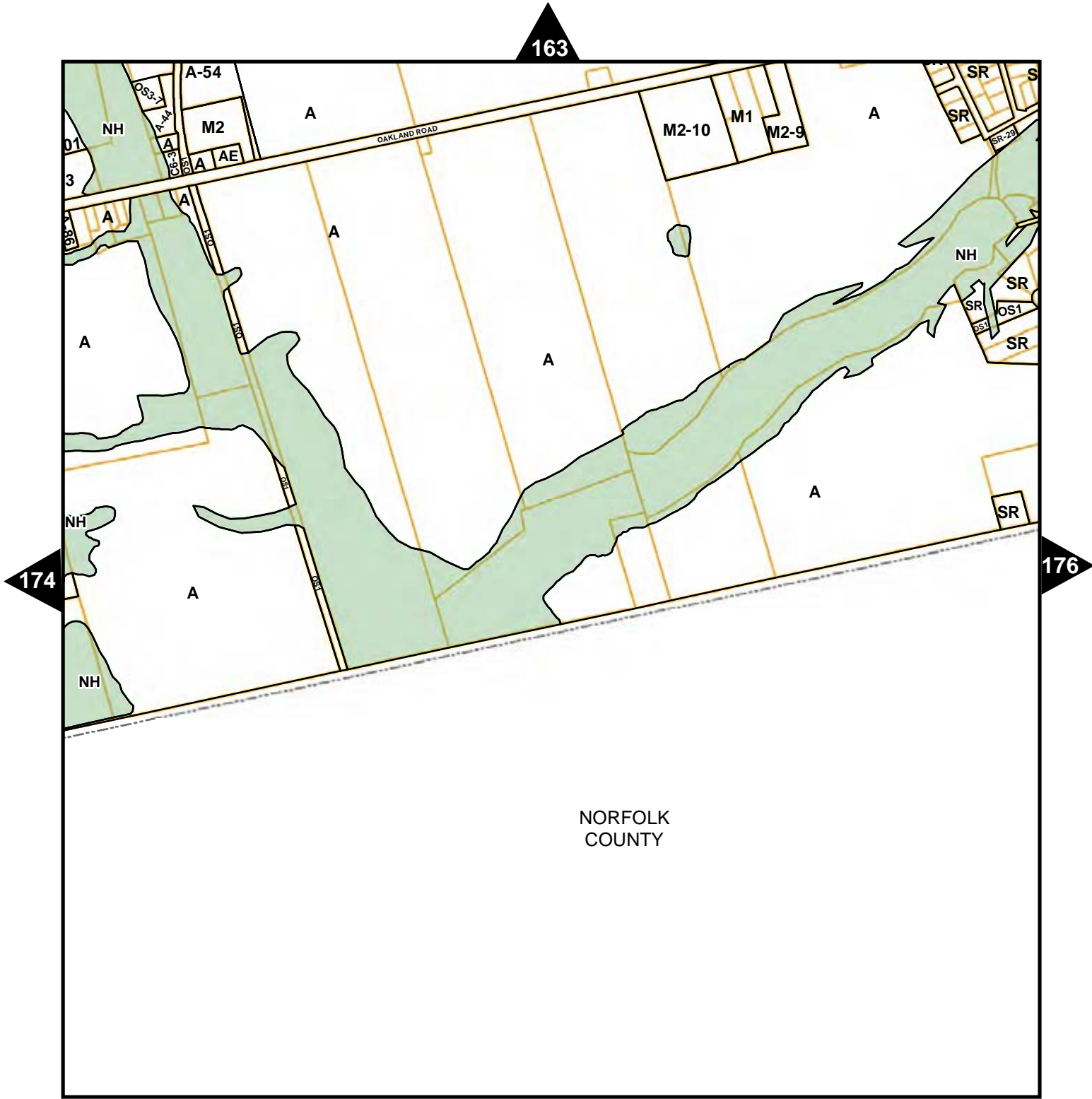
ZONING BY-LAW
SCHEDULE 'A'
Map No.174B





-  Zoning
-  Natural Heritage
-  Parcel Fabric

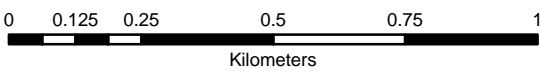

ZONING BY-LAW
SCHEDULE 'A'
Map No. 175



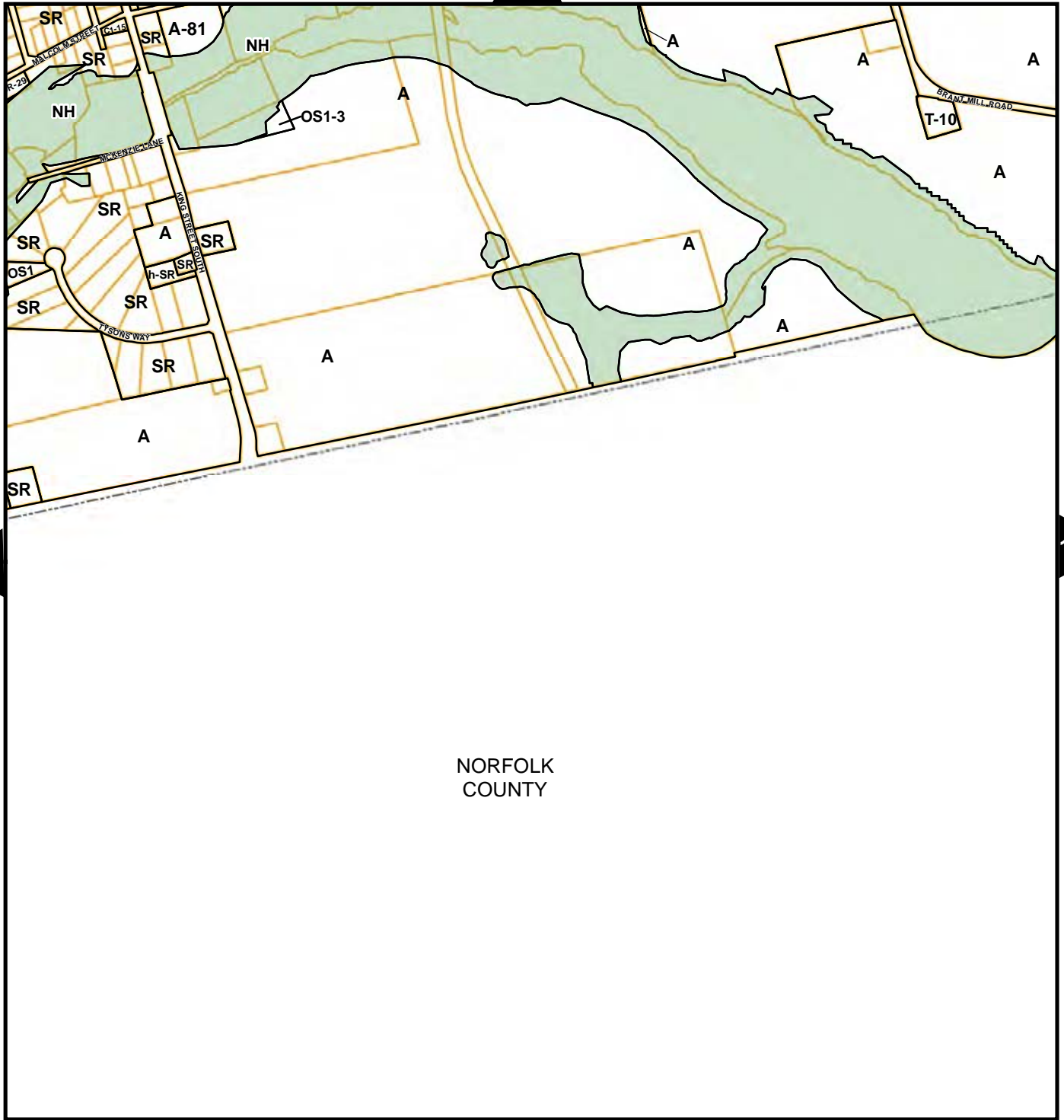

164



175

177



-  Zoning
-  Natural Heritage
-  Parcel Fabric

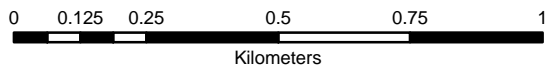

ZONING BY-LAW
SCHEDULE 'A'
Map No. 176



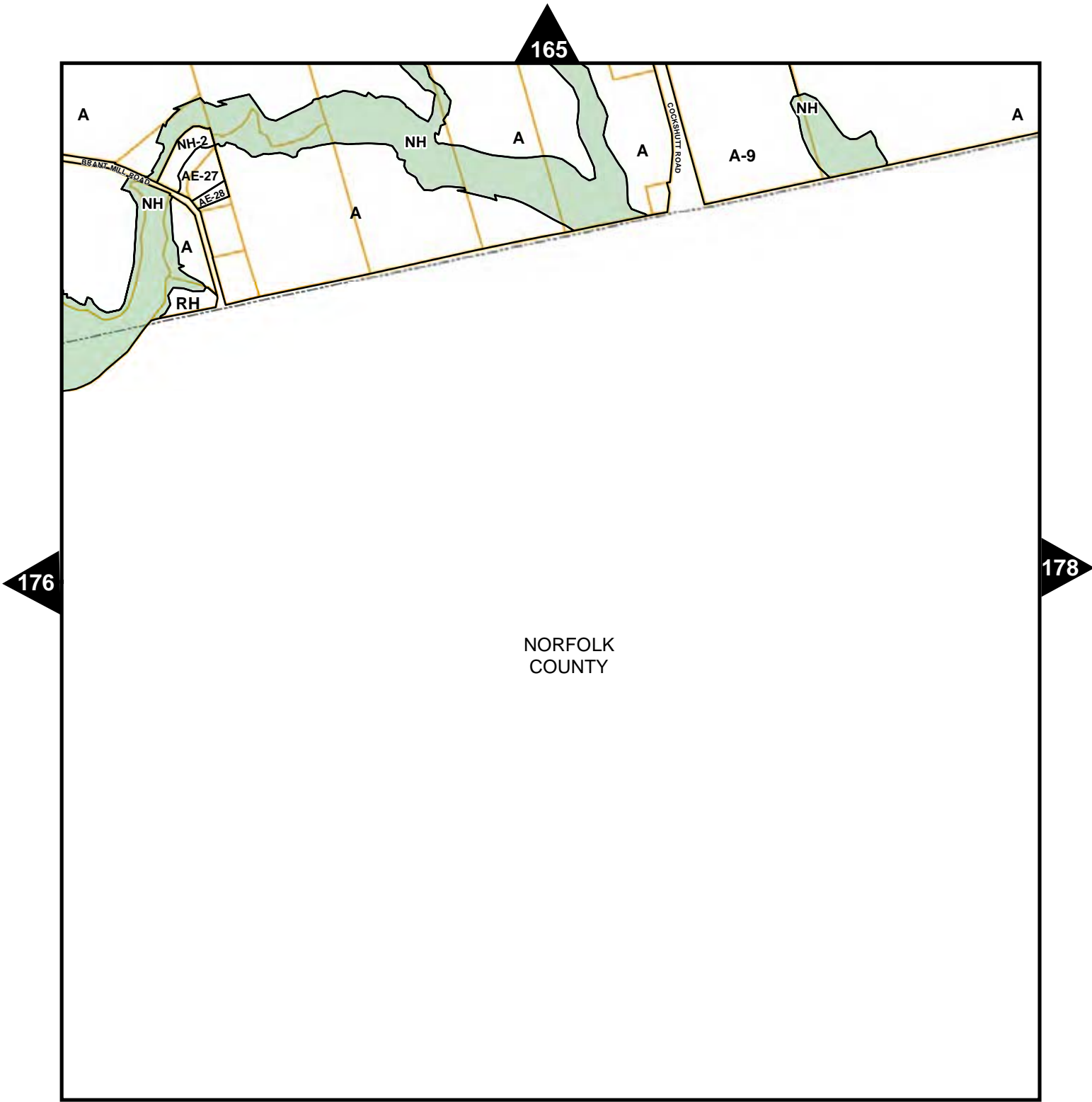

- Zoning
- Natural Heritage
- Parcel Fabric



ZONING BY-LAW SCHEDULE 'A' Map No. 177





166

A

177

NORFOLK COUNTY



-  Zoning
-  Natural Heritage
-  Parcel Fabric

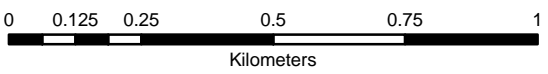

ZONING BY-LAW
SCHEDULE 'A'
Map No. 178



168

180



COUNTY OF OXFORD

THIS FIFTY CONGRESSION ROAD

A
NH
A



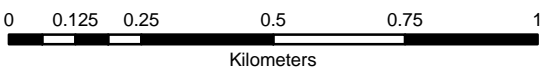

ZONING BY-LAW SCHEDULE 'A' Map No. 179

-  Zoning
-  Natural Heritage
-  Parcel Fabric

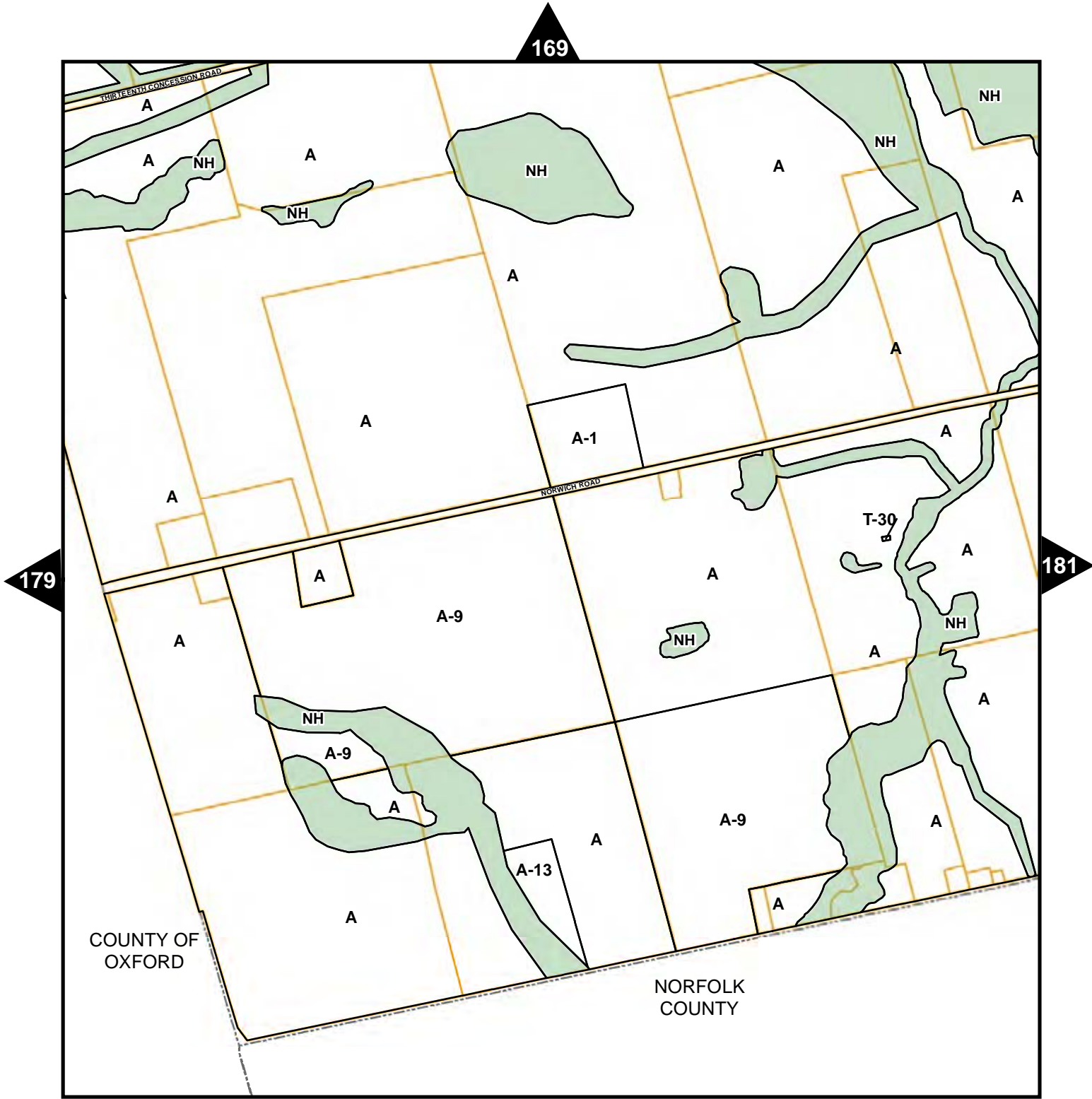





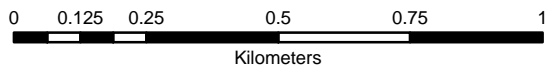

-  Zoning
-  Natural Heritage
-  Parcel Fabric

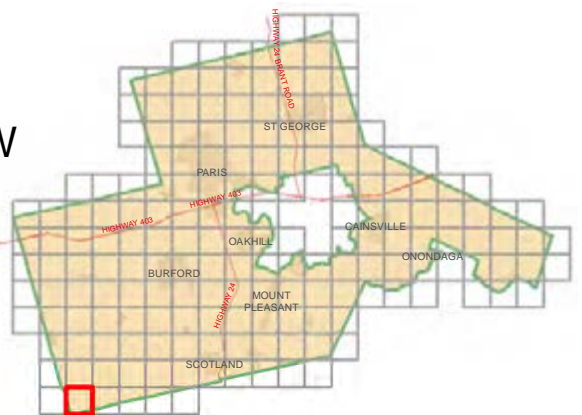

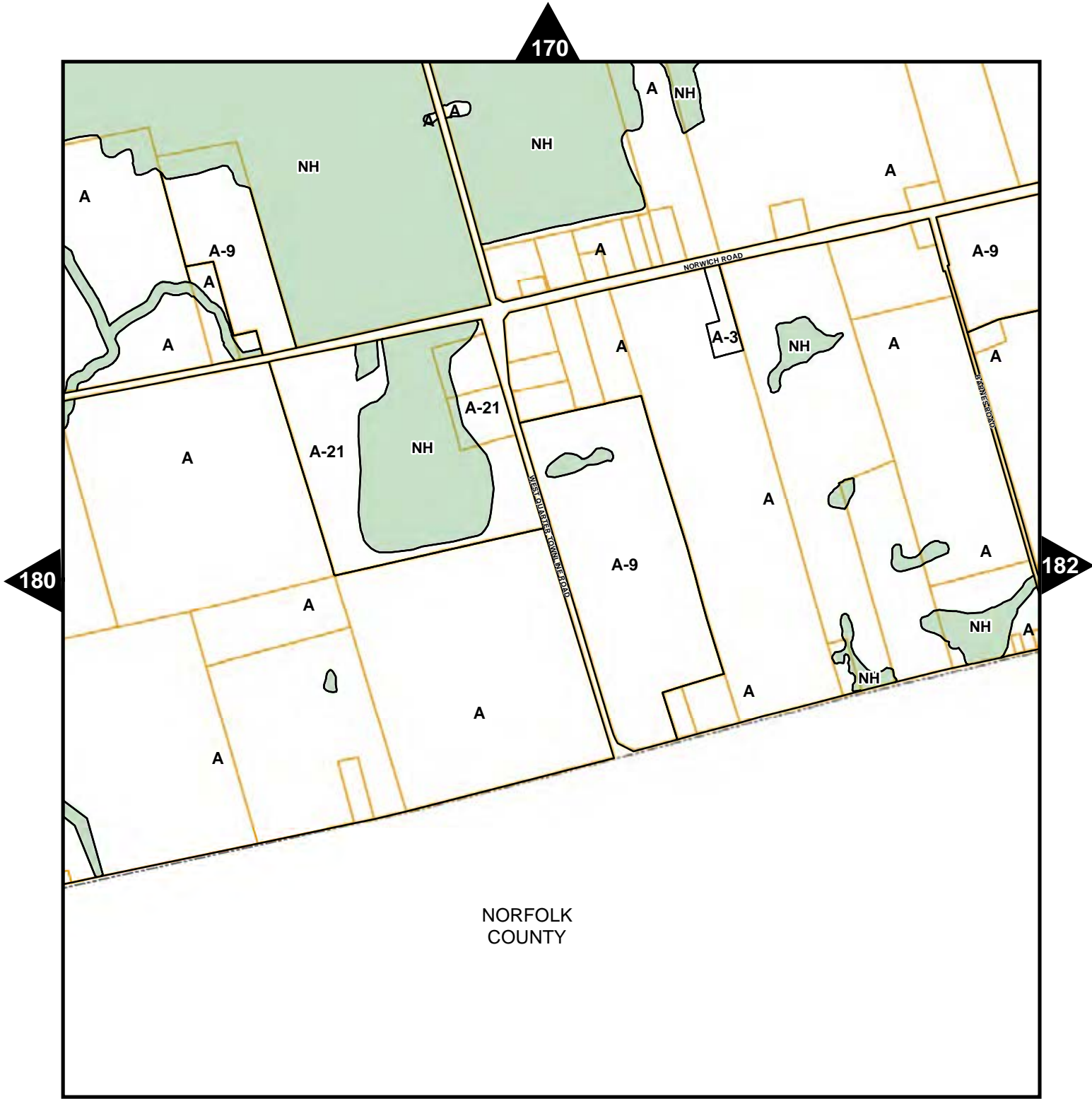
ZONING BY-LAW SCHEDULE 'A' Map No. 180





-  Zoning
-  Natural Heritage
-  Parcel Fabric

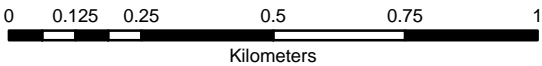

ZONING BY-LAW
SCHEDULE 'A'
Map No. 181



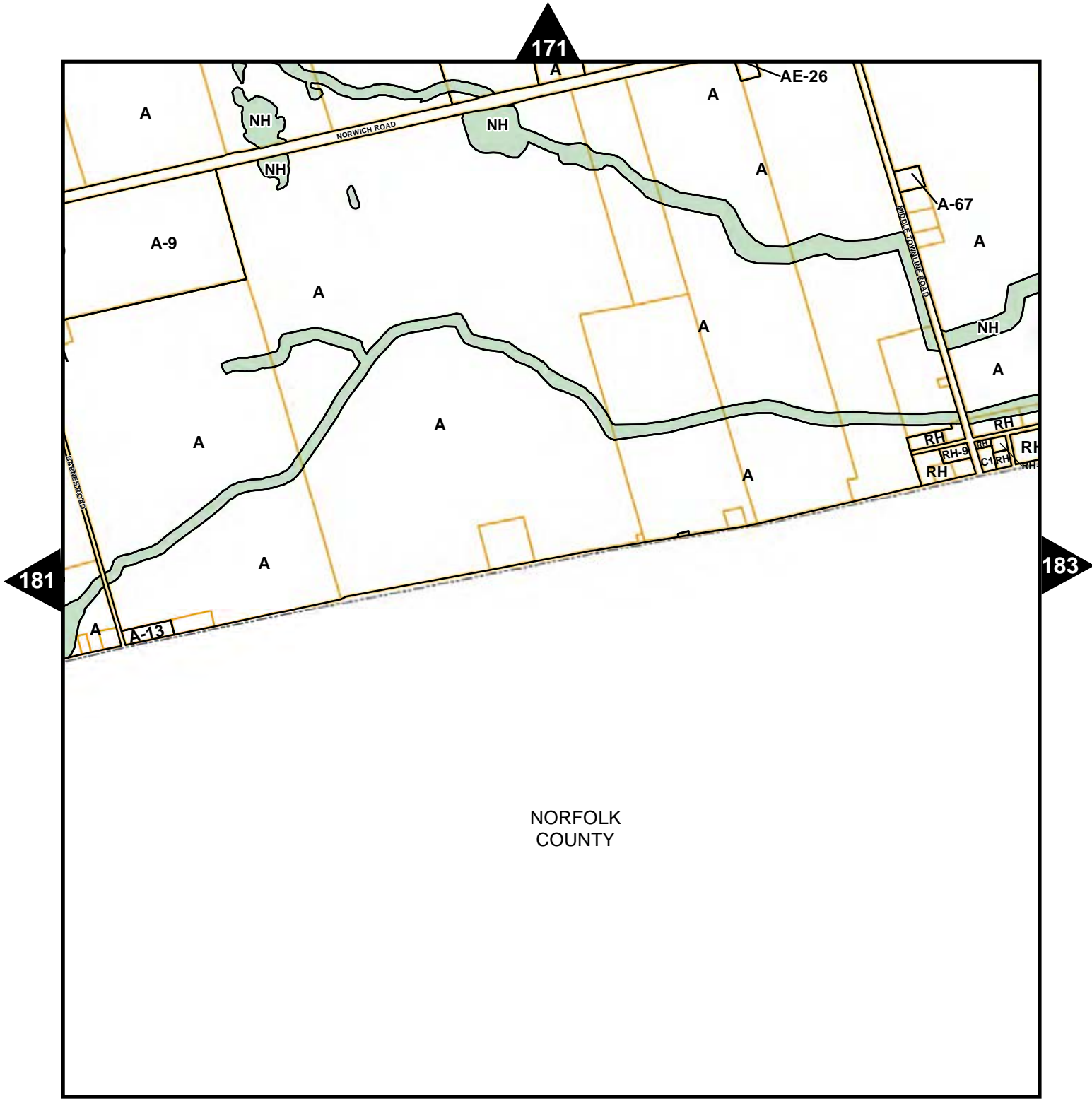

- Zoning
- Natural Heritage
- Parcel Fabric



ZONING BY-LAW
SCHEDULE 'A'
Map No. 182

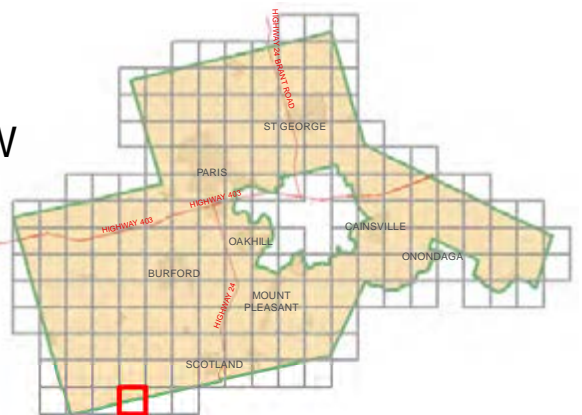

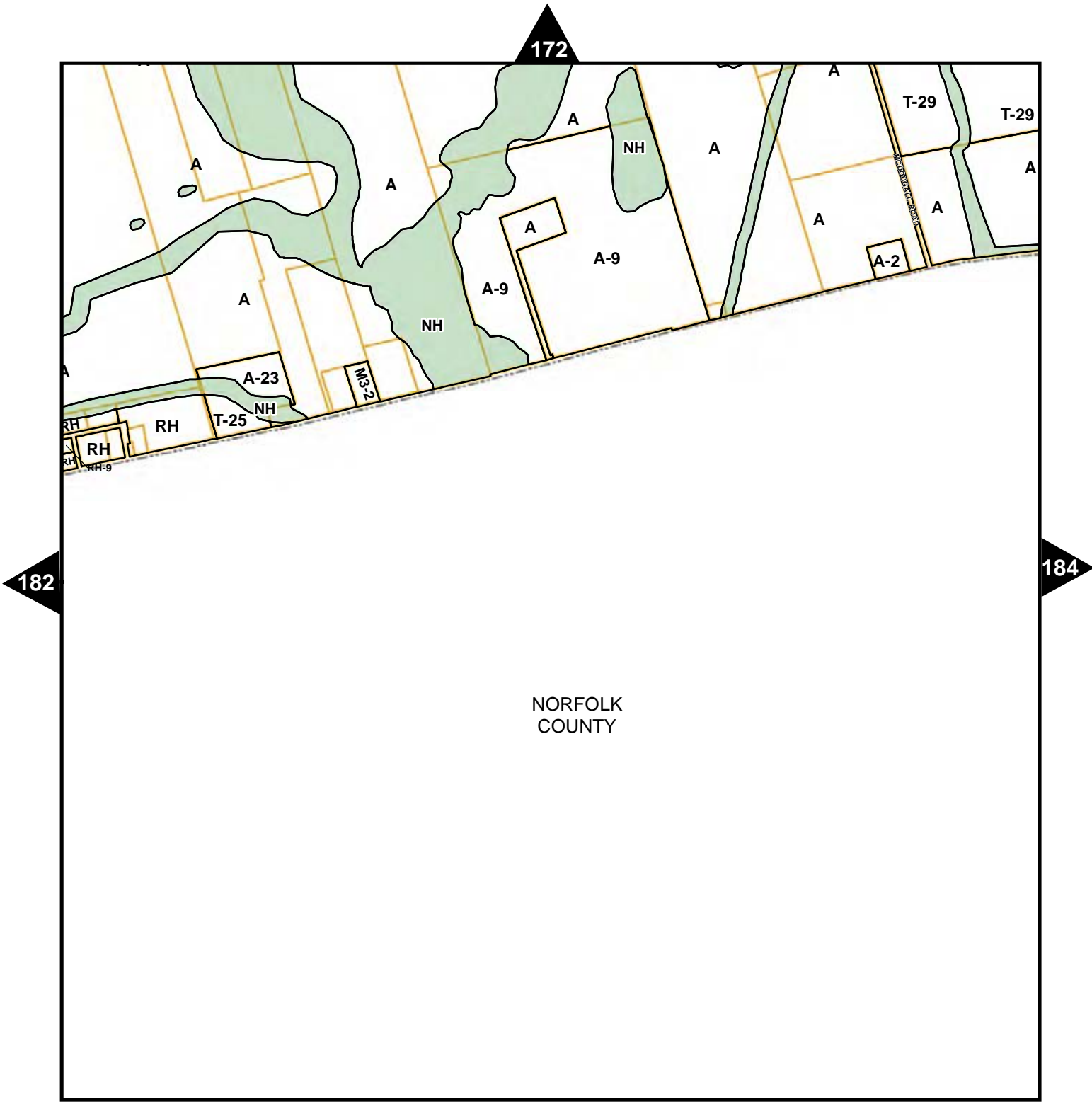





- Zoning
- Natural Heritage
- Parcel Fabric

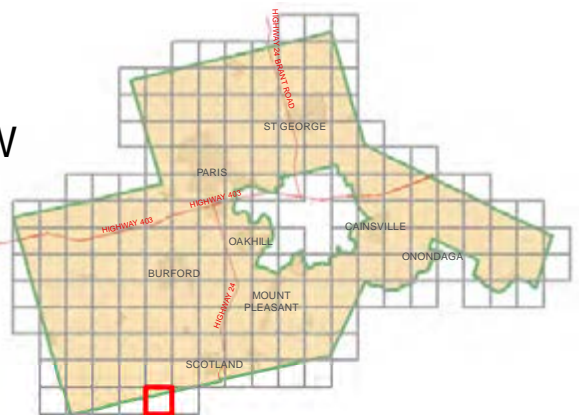

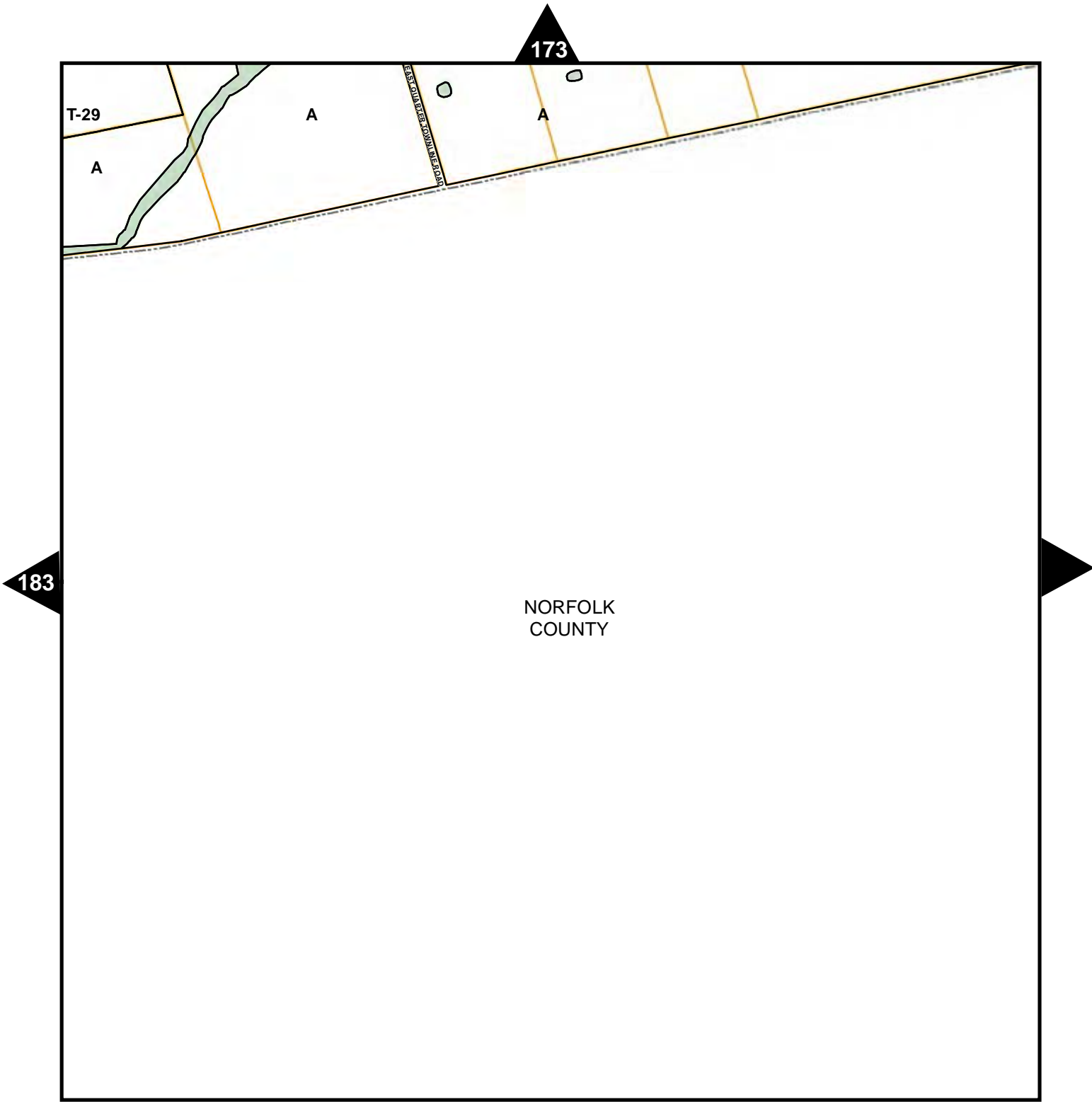
ZONING BY-LAW SCHEDULE 'A' Map No. 183





-  Zoning
-  Natural Heritage
-  Parcel Fabric

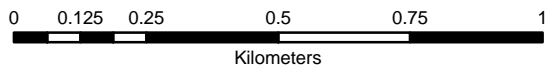

ZONING BY-LAW
SCHEDULE 'A'
Map No. 184

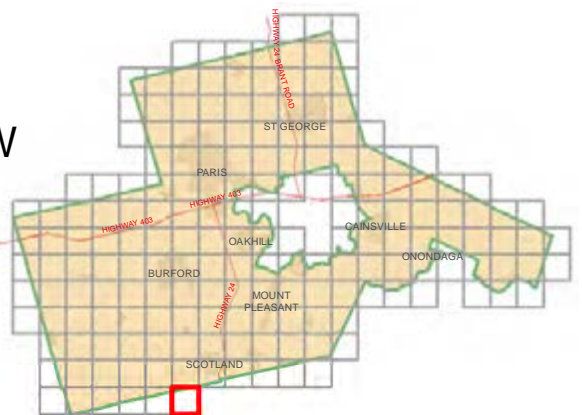

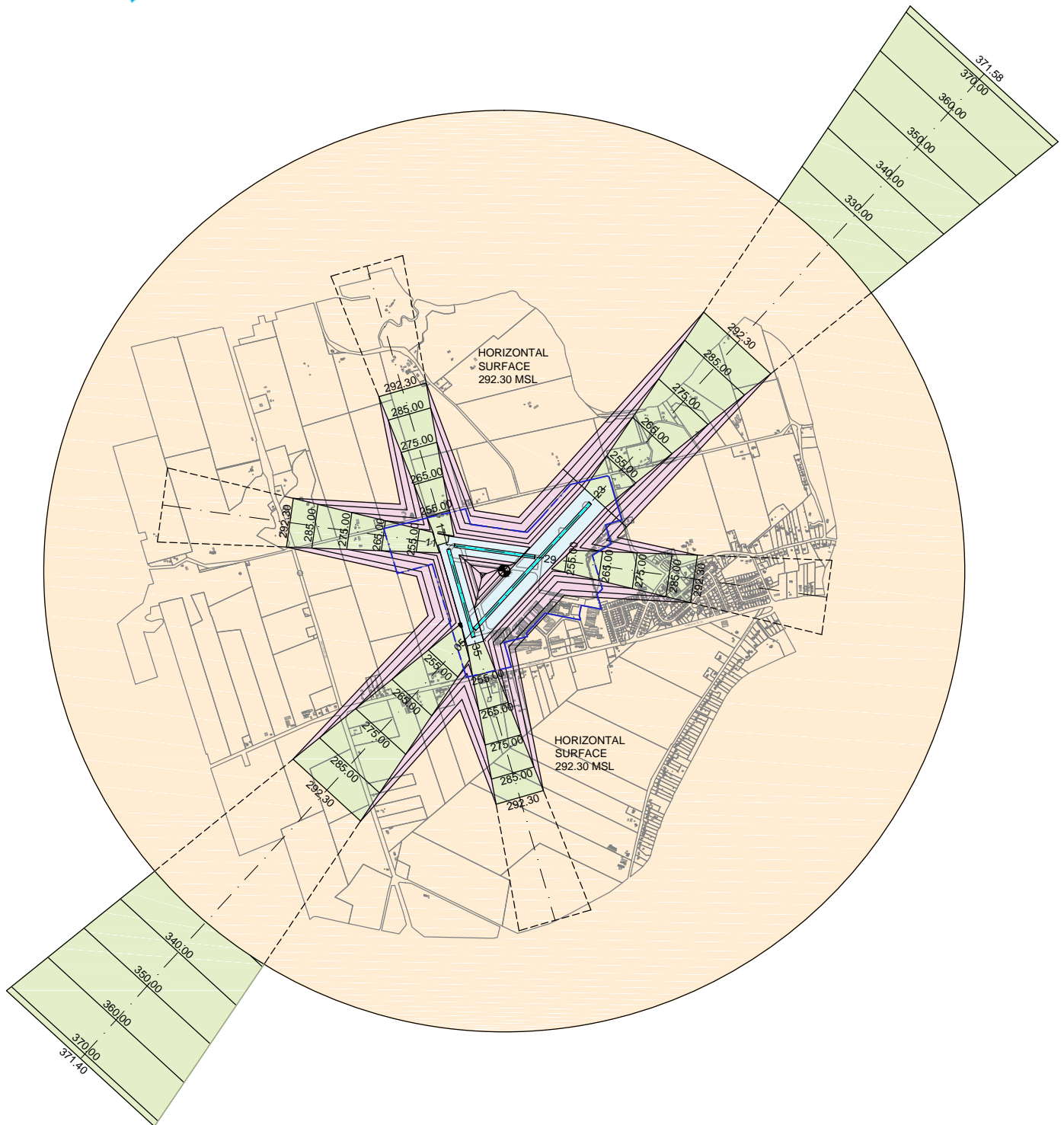

legend



APPROACH SURFACE



TRANSITIONAL SURFACE



RUNWAY STRIP



AIRPORT REFERENCE POINT

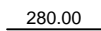

280.00
OBSTACLE HEIGHT
LIMITATION CONTOUR



AIRPORT PROPERTY BOUNDARY

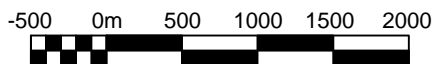

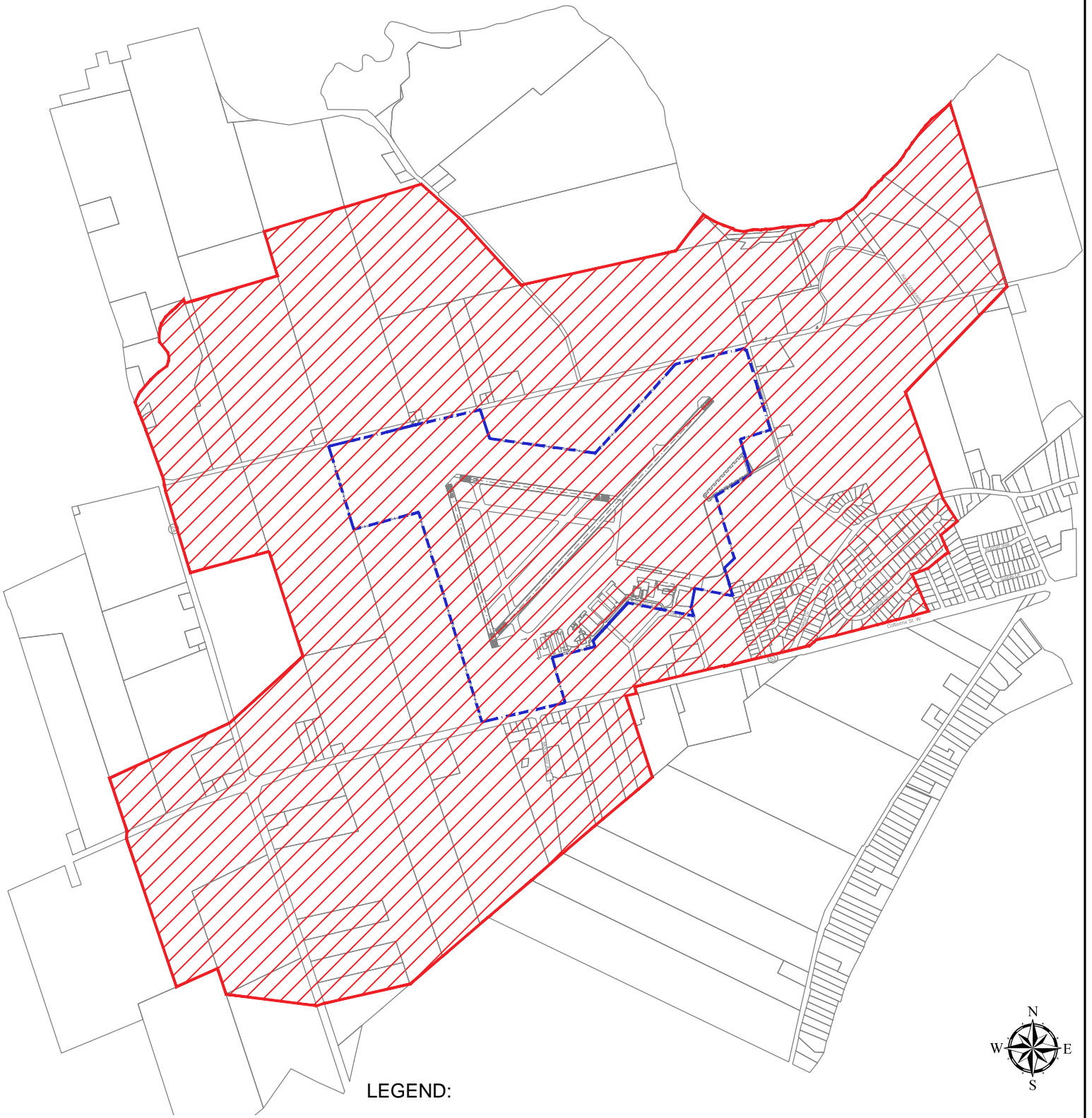



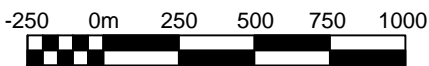

LEGEND:

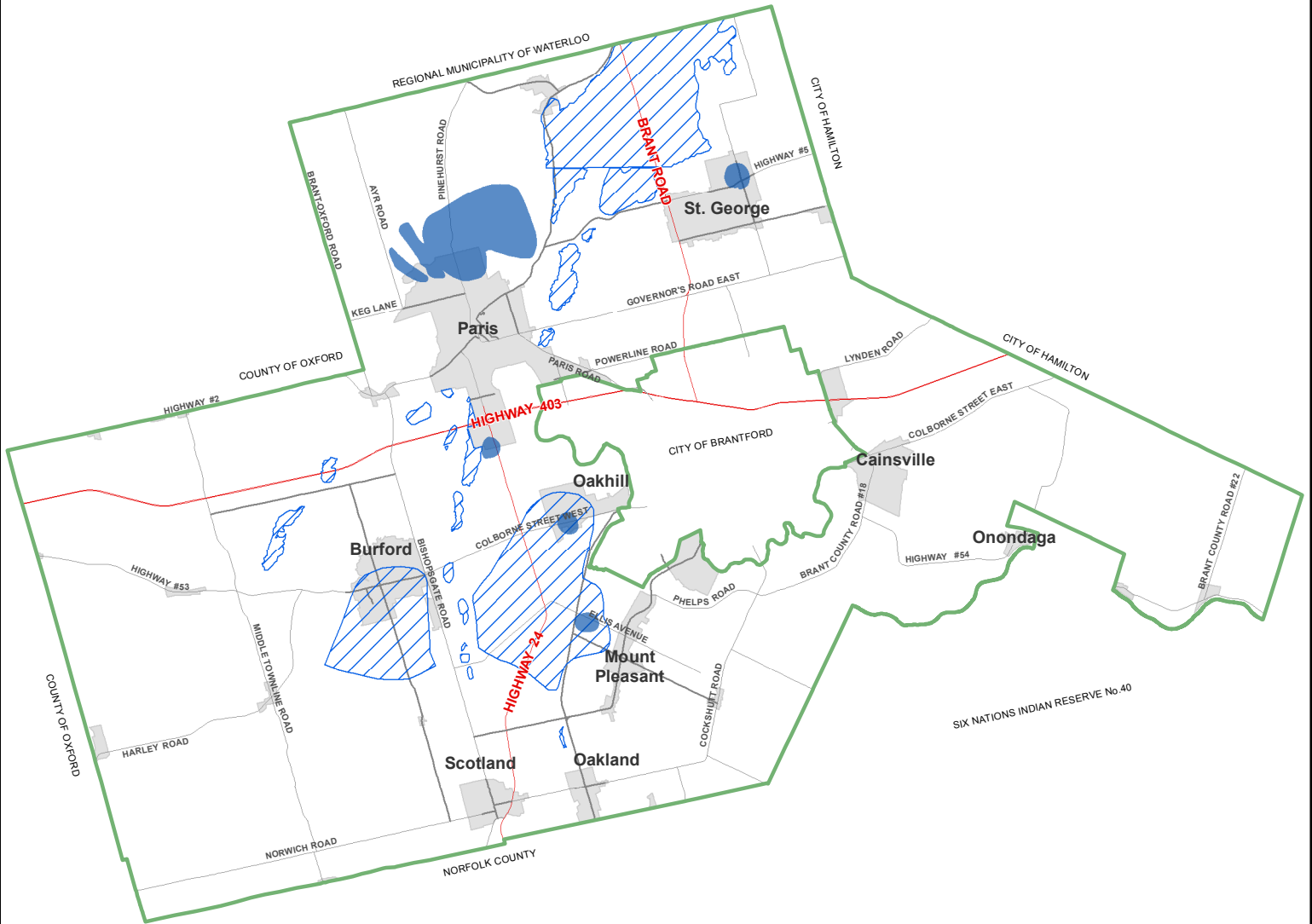
- EXISTING AIRPORT PROPERTY BOUNDARY
-  AIRPORT PROTECTION OVERLAY ZONE





Note:
Schedule "D" represents Wellhead Protection Areas and Ground Water Recharge Areas as shown in the Official Plan and is for information purposes only. The Source Protection Plan with additional details will come in effect July 1st, 2016 and an Official Plan Amendment followed by a Zoning By-Law Amendment would be required to update this schedule.

-  County Boundary
-  Wellhead Protection Areas
-  Groundwater Recharge Areas

